

X2/X3

MUSIC WORKSTATION

Basic Guide

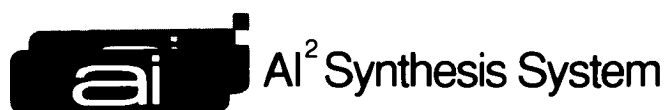

KORG

IMPORTANT SAFETY INSTRUCTIONS

WARNING — When using electrical products, basic precautions should be followed, including the following:

1. Read all the instructions before using the product.
2. Do not use this product near water — for example, near a bathtub, washbowl, kitchen sink, in a wet basement, or near a swimming pool, or the like.
3. This product should be used only with the cart or stand that is recommended by the manufacturer.
4. This product, either alone or in combination with an amplifier and headphones or speakers, may cause permanent hearing loss. Do not operate for a long period of time at a high volume level or at a level that is uncomfortable. If you experience any hearing loss or ringing in the ears, you should consult an audiologist.
5. The product should be located so that its location or position does not interfere with its proper ventilation.
6. The product should be located away from heat sources such as radiators, heat registers, or other products that produce heat.
7. The product should be connected to a power supply of the type described in the operating instructions or as marked on the product.
8. The power-supply cord of the product should be unplugged from the outlet when left unused for a long period of time.
9. Care should be taken so that objects do not fall and liquids are not spilled into the enclosure through openings.
10. The product should be serviced by qualified personnel when:
 - A. The power-supply cord or the plug has been damaged; or
 - B. Objects have fallen, or liquid has been spilled into the product; or
 - C. The product has been exposed to rain; or
 - D. The product does not appear to operate normally or exhibits a marked change in performance; or
 - E. The product has been dropped, or the enclosure damaged.
11. Do not attempt to service the product beyond that described in the user-maintenance instructions. All other servicing should be referred to qualified service personnel.

SAVE THESE INSTRUCTIONS

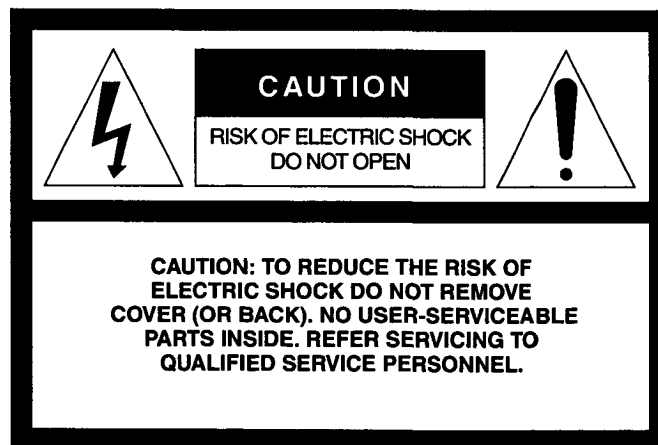

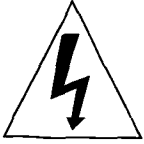

The lightning flash with the arrowhead symbol within an equilateral triangle, is intended to alert the user to the presence of uninsulated "dangerous voltage" within the product's enclosure that may be of sufficient magnitude to constitute a risk of electric shock.



The exclamation point within an equilateral triangle is intended to alert the user to the presence of important operating and maintenance (servicing) instructions in the literature accompanying the product.

GROUNDING INSTRUCTIONS

This product must be grounded (earthed). If it should malfunction or breakdown, grounding a path of least resistance for electric current to reduce the risk of electric shock. This product is equipped with a cord having an equipment-grounding conductor and a grounding plug. The plug must be plugged into an appropriate outlet that is properly installed and grounded in accordance with the local codes and ordinances.

DANGER – Improper connection of the equipment-grounding conductor can result in a risk of electric shock. Check with a qualified electrician or serviceman if you are in doubt as to whether the product is properly grounded. Do not modify the plug provided with the product – if it will not fit the outlet, have a proper outlet fitted.

THE FCC REGULATION WARNING

This equipment generates and uses radio frequency energy and if not installed and used properly, that is, in strict accordance with the manufacturer's instructions, may cause interference to radio and television reception. It has been type tested and found to comply with the limits for a Class B computing device in accordance with the specifications in Subpart J of Part 15 FCC Rules, which are designed to provide reasonable protection against such interference in a residential installation. However, there is no guarantee that the interference will not occur in a particular installation. If this equipment does cause interference to radio and television reception, which can be determined by turning the equipment off and on, the user is encouraged to try to correct the interference by one or more of the following measures:

- Reorientate the receiving antenna.
- Relocate the equipment with respect to the receiver.
- Move the equipment away from the receiver.
- Plug the equipment into a different outlet so that equipment and receiver are on different branch circuits.

If necessary, the user should consult the dealer or an experienced radio/television technician for additional suggestions. The user may find the following booklet prepared by the Federal Communications Commission helpful: "How to Identify and Resolve Radio-TV Interference Problems". This booklet is available from the U.S. Government Printing Office, Washington, D.C. 20402, Stock No. 004-000-00345-4.

CANADA

THIS APPARATUS DOES NOT EXCEED THE "CLASS B" LIMITS FOR RADIO NOISE EMISSIONS FROM DIGITAL APPARATUS SET OUT IN THE RADIO INTERFERENCE REGULATION OF THE CANADIAN DEPARTMENT OF COMMUNICATIONS.

LE PRESENT APPAREIL NUMERIQUE N'EMET PAS DE BRUITS RADIOELECTRIQUES DEPASSANT LES LIMITES APPLICABLES AUX APPAREILS NUMERIQUES DE LA "CLASSE B" PRESCRITES DANS LE REGLEMENT SUR LE BROUILLAGE RADIOELECTRIQUE EDICTE PAR LE MINISTERE DES COMMUNICATIONS DU CANADA.

Trademarks

MS-DOS is a registered trademark of Microsoft, Inc.

All trademarks or registered trademarks are the property of their respective holders.

Table of Contents

Introduction	1
Welcome to the X2/X3	1
Unpacking Your X2/X3	1
X2/X3 Manuals	1
X2/X3 Features	1
What is the X2/X3?	2
X2/X3 Architecture	2
Sequencer	3
Digital Multi-Effects Processors	3
Floppy Disk Drive	3
General MIDI	3
SMF (Standard MIDI Files)	3
X2/X3 Memory Banks	4
Output Routing	4
X2/X3 Modes	4
Chapter 1: Controls & Connections	5
Front Panel	5
Rear Panel	10
Chapter 2: Setting Up the X2/X3	12
Connecting Audio Equipment	12
Power On Procedure	13
LCD Contrast	13
Listening to the Demo Song	13
MIDI Connections	13
Chapter 3: Getting Around the X2/X3	16
The LCD	16
Selecting LCD Screens	18
Selecting Parameters	18
Setting Parameters	19
Comparing While Editing	19
Useful Notes	19
MIDI Notes	19
Chapter 4: Program Play Tutorial	20
Changing the X2/X3 Global MIDI Channel	20
Selecting Banks & Programs	21
Editing in Program Play Mode	22
Chapter 5: Combination Play Tutorial	23
Combination Structure	23
Timbre MIDI Channels	24
Playing Combinations	24
Selecting Banks & Combinations	25
Editing in Combination Play Mode	26

Chapter 6: Combination Edit Tutorial	27
Combination Types	27
Editing Combinations	28
Using the X2/X3 as a MultiTimbral Tone Generator	29
Saving Combinations	29
Chapter 7: Effects Tutorial	30
What is a Multi-Effects Processor?	30
Effect Types	30
Using the Effects	33
Chapter 8: Program Edit Tutorial	34
Three Sound Building Blocks	34
Volume Editing	34
Tone Editing	35
A Few Words about Pitch	36
What is Double Mode?	37
Programs with Effects	37
Saving Programs	37
Creating Original Sounds	37
Chapter 9: Using the X2/X3 Sequencer	38
Using the X2/X3 as Your Main Sequencer	38
Using the X2/X3 Sequencer as a Musical Sketch Pad	39
Chapter 10: Playing GM Songs	40
About GM Song Data	41
Chapter 11: X2/X3 Data Compatibility	42
X2, X3, X3R	42
Compatibility with 03R/W Cards	42
Compatibility with i2/i3 Floppy Disks	43
Chapter 12: X2/X3 Sound Lists	44
Combinations	44
Programs	46
Drum Kits	48
ROM Drum Kits	49
Multisounds	51
Drum Sounds	52

Introduction

Welcome to the X2/X3

Thank you for purchasing a Korg X2/X3 Music Workstation, and welcome to the exciting world of AI² Synthesis.

Unpacking Your X2/X3

The following items should be enclosed with your X2/X3. Make sure that you have them all.

- *Basic Guide*
- *Reference Guide*
- X2/X3 data floppy disk
- Power cable
- Guarantee Card

Keep the packaging materials for when you want to transport the X2/X3 in the future.

X2/X3 Manuals

The X2/X3 is supplied with two user manuals: this *Basic Guide* and a *Reference Guide*.

This *Basic Guide* explains how to set up, switch on, and play the X2/X3. Using a tutorial style format, it also introduces some of the X2/X3 functions. Use this guide first, then when you want to know the full details, refer to the *Reference Guide*.

The *Reference Guide* contains full details about all the X2/X3's functions. It also contains an index that will help you to locate information quickly.

X2/X3 Features

- Korg's AI² Synthesis technology
- Multi-sampled PCM Multisounds
- 336 internal Programs
- 200 internal Combinations
- 114 drum and percussion sounds
- 32-note polyphony in Single Program mode, 16-note polyphony in Double Program mode
- Two digital multi-effects processors, each with 47 effect types and dynamic modulation
- 16-track sequencer: 10 songs, 100 patterns, 32,000 event capacity, powerful editing functions
- Editable Program and Combination parameters while playing
- GM (General MIDI) compatibility
- 3.5 inch floppy disk drive for data storage
- Read and write SMF (Standard MIDI Files)
- MIDI Exclusive data recorder function
- PROG/SEQ (RAM) card slot for Programs, Combinations, and sequencer data
- PCM data (ROM) card slot for adding more Multisounds and drum sounds
- All data, including sequencer data, is stored when the X2/X3 is powered off.

What is the X2/X3?

The following illustration shows the basic parts that make up the X2/X3 Music Workstation.

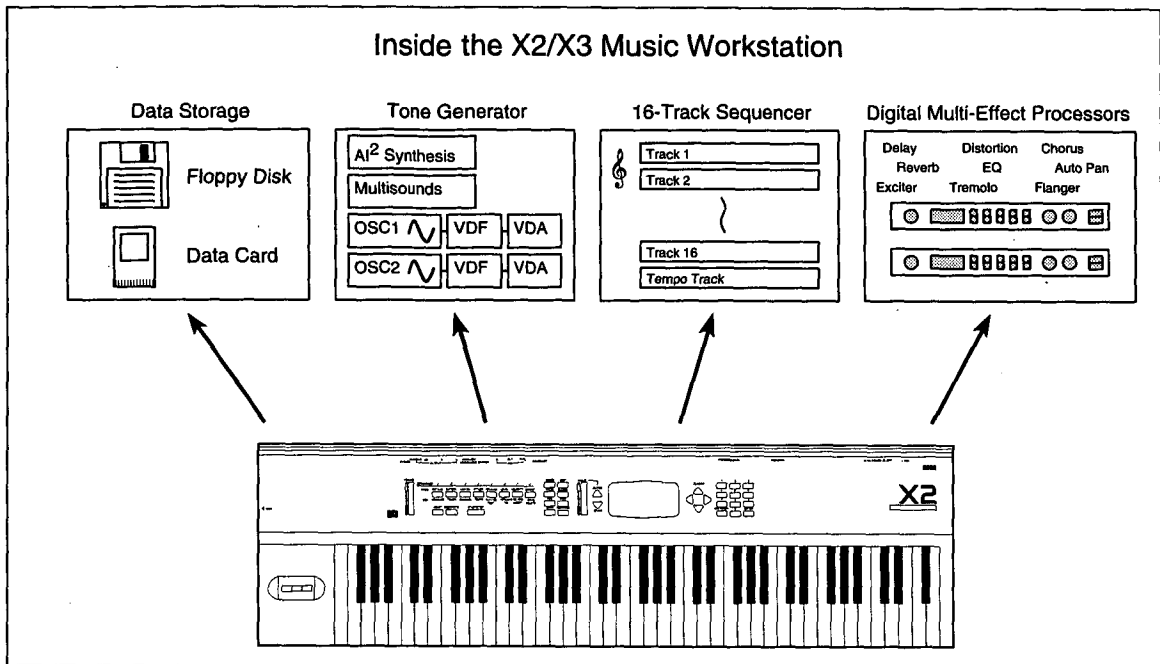

X2/X3 Architecture

AI² Synthesis Technology: this is a technique developed by Korg for capturing the true essence of acoustic sounds for use in a tone generator.

Multisounds: these are the basic sound elements. The X2 contains 341 Multisounds. The X3 contains 340 Multisounds. More can be added using optional PCM data cards. Internal Multisounds and drum sounds are stored in ROM (8MB on the X2, 6MB on the X3).

Programs: can use one or two oscillators, Single mode and Double mode, respectively. Each oscillator is assigned a Multisound, and has an independent VDA (Variable Digital Amplifier) and VDF (Variable Digital Filter). Oscillators share a common pitch EG (Envelope Generator) and VDF modulator. Programs are output on four buses (A, B, C, D) that feed multi-effects 1 and 2. Oscillators are assigned to buses independently.

The X2/X3 contains 336 Programs: 100 in bank A, 100 in bank B, and 136 in bank GM. More Programs can be added using optional PROG/SEQ data cards.

Combinations: can use up to eight Timbres. Each Timbre is assigned a Program, MIDI Channel, etc. Combinations are ideal for layering Programs and multi-timbral type sequencing. Timbres can be assigned to specific areas of the keyboard for split type Combinations, and to specific note velocities for velocity crossover type Combinations. Combinations are output on four buses (A, B, C, D) that feed multi-effects 1 and 2. Timbres are assigned to buses independently.

The X2/X3 contains 200 Combinations: 100 in bank A, and 100 in bank B. More Combinations can be added using optional PROG/SEQ data cards.

Drum kits: the X2/X3 contains 164 drum sounds. More can be added using optional PCM data cards that contain drum sounds. Drum sounds are arranged into 8 ROM kits and 4 user kits. Each drum kit contains 60 indexes, with one drum sound assigned to each index. Extra drum kits can be stored on a PROG/SEQ data card. Level, pan, tuning, and decay parameters can be set individually for each index in a kit.

Sequencer

The X2/X3 contains a 16-track sequencer that has a maximum event capacity of 32,000. Up to 10 songs and 100 patterns can be held in memory simultaneously. Up to 999 measures can be contained. Each track is assigned a Program, MIDI Channel, etc. A tempo track is provided for entering tempo changes. Tracks and patterns can be recorded in real time and step time. Patterns can also be created by copying a specified section of a track. Patterns can be copied or put into tracks. EXT mode tracks can be used to control other MIDI instruments.

Songs are output on four buses (A, B, C, D) that feed multi-effects 1 and 2.

Digital Multi-Effects Processors

The X2/X3 contains two digital multi-effects processors that can produce 47 effects such as reverb, delay, chorus, flanger, distortion, EQ, auto pan, exciter, etc. Effects 1 to 37 are single effects, 38 and 39 are serial effects, and 40 to 47 are parallel effects. The parallel type effects allow up to four independent effects simultaneously.

Each Program, Combination, and song can have its own effect settings. When a Program is used as part of a Combination or song, its own effects settings are ignored, and effects settings for that particular Combination or song are used.

Floppy Disk Drive

An internal 3.5 inch 2DD floppy disk drive provides a convenient way to store your Programs, Combinations, sequencer songs, and patterns. In addition, MIDI Exclusive data from other MIDI devices can be stored and loaded via the disk drive, just like a MIDI data filer. The X2/X3 floppy disk format is compatible with the MS-DOS 720KB disk format, making it easy to exchange SMF (Standard MIDI File) data with other users.

General MIDI

GM (General MIDI) is a MIDI Standard implemented by a number of manufacturers. Among other things, it states that a GM compatible tone generator must have 128 specific programs, be able to produce at least 24 notes simultaneously, and use MIDI Channel 10 for drums and percussion. The main reason for GM is to improve song data compatibility between different music systems.

In sequencer mode, you can play and record GM compatible songs. This allows you to swap song files with other GM compatible musicians—with ease.

The GM standard does not specify effect types, tone generator architecture, or sound generation processes, so song files produced using other tone generators will not sound exactly the same on the X2/X3. If you are depending on GM compatibility, create a few sample song files to check compatibility with the system that you hope to exchange data.

See “Playing GM Songs” on page 40 for more details.

SMF (Standard MIDI Files)

SMF allows you to transfer song data between sequencing systems. It is a standard format for sequence data. Most recent software and hardware sequencers support SMF.

SMF files come in three formats: Format 0, Format 1, and Format 2. The X2/X3 supports formats 0 and 1. In format 0, data of all tracks is merged onto one track and saved to floppy disk. In format 1, data is saved on individual tracks. Format 1 is more common.

SMF data does not necessarily conform to the GM standard, however, SMF is a useful way of transferring song data between GM compatible music systems.

Note: *GS compatible data is similar to GM data. However, GS data played on a GM tone generator will not sound exactly the same.*

X2/X3 Memory Banks

The following table shows how the X2/X3 memory banks are organized.

Bank A	Bank B	Bank GM (ROM)	Bank C (PROG/SEQ Card)	Bank D (PROG/SEQ Card)
100 Programs	100 Programs	136 Programs	100 Programs	100 Programs
100 Combinations	100 Combinations	—	100 Combinations	100 Combinations
Drum kits A1 and A2	Drum kits B1 and B2	ROM Drum kits 1–8	Drum kits C1 and C2	Drum kits D1 and D2
Global setup data				

Sequencer data (10 songs, 100 patterns, 32,000 events max.) is stored in internal RAM. Sequencer data (10 songs, 100 patterns, 7,000 events max.) can also be saved to PROG/SEQ data card bank C or D. See “PROG/SEQ Data Cards” on page 197 of the *Reference Guide*.

Output Routing

The following illustration shows how Programs, Combinations, and songs are output. Pan, Send C, and Send D parameters can be set individually for each Program oscillator, Combination Timbre, and song track. The four output buses A, B, C, and D are fed to the two multi-effects processors, and subsequently mixed down to outputs 1L/MONO, 2/R, 3, and 4 on the X2, and outputs L/MONO and R on the X3. Buses can be routed through the effects processors in six different ways, called placements. See “7E Effect Placement” on page 59 of the *Reference Guide* for details about effect placements.

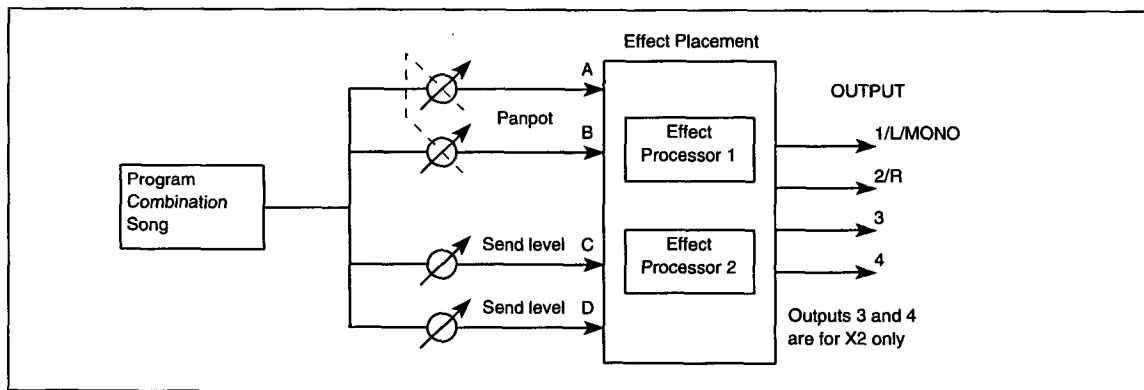

X2/X3 Modes

The following table lists the X2/X3 operating modes and gives a brief explanation of what you can do in each mode.

Mode	What You Can Do
Program Play mode	Play and select Programs, edit some parameters.
Program Edit mode	Edit all Program parameters, set up Program effects, write Programs to memory.
Combination Play mode	Play and select Combinations, edit some parameters.
Combination Edit mode	Edit all Combination parameters, set up Combination effects, write Combinations to memory.
Sequencer mode	Play back songs and record in real time.
Sequencer Edit mode	Record in step time, record patterns in real time and step time, set up song effects, edit tracks, patterns, etc.
Global mode	Set parameters that change the overall performance of the X2/X3 such as the Global MIDI Channel, master tune, transpose, MIDI filters, memory protection, save and load data to a PROG/SEQ data card, set up the drum kits, assignable pedal, etc.
Disk mode	Save and load X2/X3 data to floppy disk, save and load MIDI Exclusive data, save and load SMF (Standard MIDI Files), delete disk files, rename disk files, etc.

Chapter 1: Controls & Connections

Front Panel

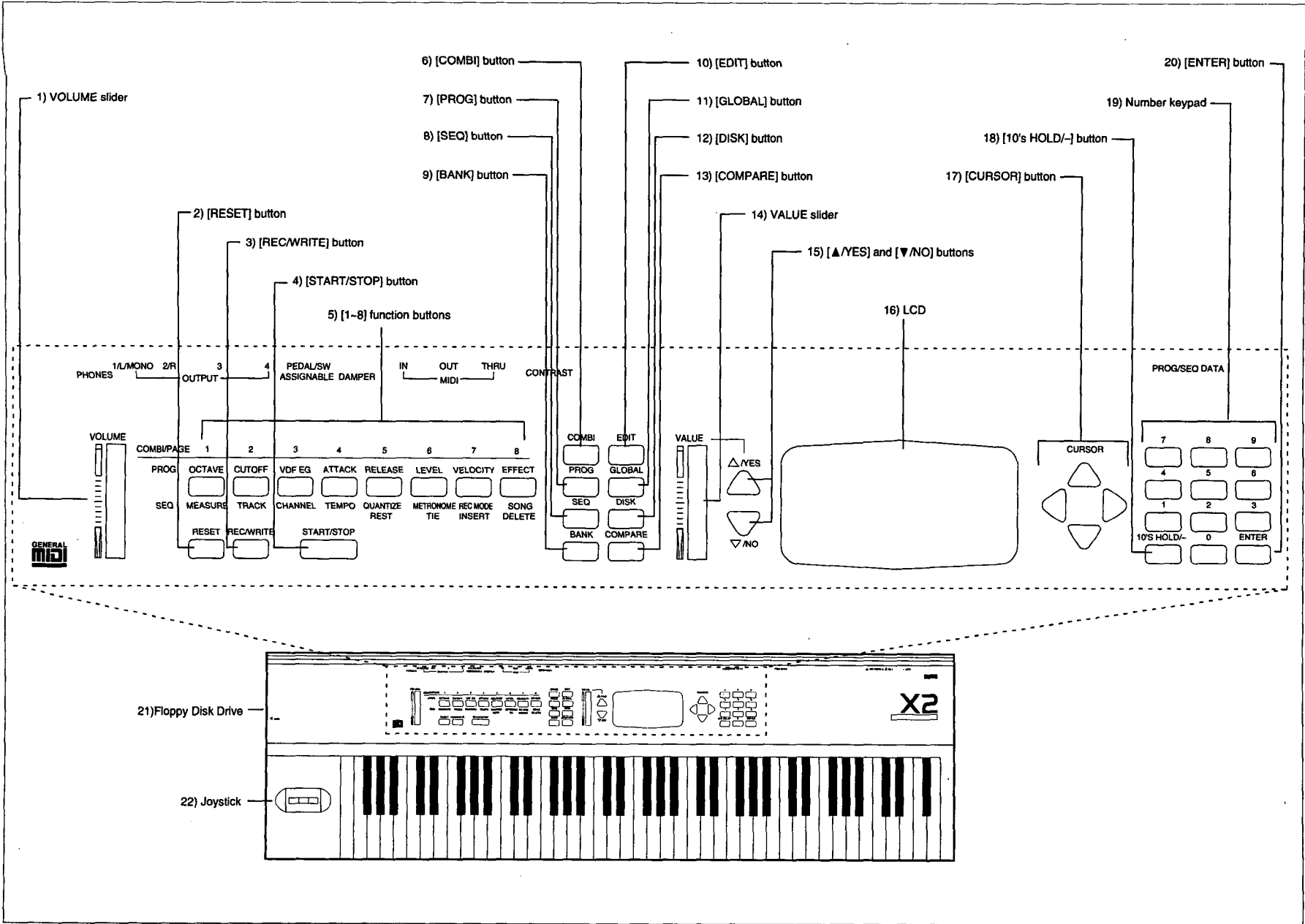

1) VOLUME slider

This slider adjusts the output volume of the X2/X3. It also controls the headphone volume.

2) [RESET] button

This button works in Sequencer mode and Sequencer Edit mode. When the sequencer is stopped, pressing this button will return the song to the beginning. If, for some reason, the sound being produced cannot be stopped, press this button.

3) [REC/WRITE] button

The operation of this button depends on the selected mode:

Sequencer and Sequencer Edit Modes: pressing this button will engage Record Ready mode, and REC will appear on the LCD screen. To cancel Record Ready mode, press again. To start recording, press the [START/STOP] button.

Program Play, Program Edit, Combination Play, Combination Edit modes: pressing this button allows you to write the current Program or Combination to memory.

4) [START/STOP] button

This button works in Sequencer mode and Sequencer Edit mode. It is used to start and stop song playback and recording.

5) [1–8] function buttons

The operation of these buttons depends on the current mode, as explained in the following table. The names of the functions that these buttons perform are printed on the X2/X3 in different colors. The table also lists how colors correspond to modes.

Current Mode	Operation
Program Play Mode	Select the various parameters that can be edited in Program Play mode. See "Editing in Program Play Mode (Performance Editing)" on page 5 of the <i>Reference Guide</i> . White text on front panel.
Program Edit Mode	Select LCD screen groups for parameters and functions in Program Edit mode. See "Program Edit Mode" on page 7 of the <i>Reference Guide</i> .
Combination Play Mode	Select a Timbre from 1 to 8 for editing in Combination Play mode. See "Editing in Combination Play Mode (Performance Editing)" on page 37 of the <i>Reference Guide</i> . Blue text on front panel.
	Individual Timbres can be soloed by double clicking on the corresponding button. See "Soloing Individual Timbres" on page 38 of the <i>Reference Guide</i> .
Combination Edit Mode	Select LCD screen groups for parameters and functions in Combination Edit mode. See "Combination Edit Mode" on page 39 of the <i>Reference Guide</i> .
Sequencer Mode	Select the various parameters for playing and recording songs. See "Sequencer Mode" on page 93 of the <i>Reference Guide</i> .
	Function button 2 can be used to solo the currently selected track. See "Soloing Individual Tracks" on page 97 of the <i>Reference Guide</i> . Green text on front panel.
Sequencer Edit Mode	Select LCD screen groups for parameters and functions in Sequencer Edit mode. See "Sequencer Edit Mode" on page 113 of the <i>Reference Guide</i> .
	For step-time recording and event edit, function buttons 5, 6, 7, 8 are used to enter rests, ties, notes, and delete notes, respectively.
Global Mode	Select LCD screen groups for parameters and functions in Global mode. See "Global Mode" on page 155 of the <i>Reference Guide</i> .
Disk Mode	Select LCD screen groups for parameters and functions in Disk mode. See "Disk Mode" on page 175 of the <i>Reference Guide</i> .

Powering on the X2/X3 while pressing the [SEQ] button and function button [8] will erase all sequencer data and initialize all parameters. Make sure that you save your important data to either floppy disk or card beforehand. See "Erase All Sequencer Data" on page 98 of the *Reference Guide*.

6) [COMBI] button

Press this button to select Combination Play mode.

7) [PROG] button

Press this button to select Program Play mode.

8) [SEQ] button

Press this button to select Sequencer mode.

Powering on the X2/X3 while pressing the [SEQ] button and function button [8] will erase all sequencer data and initialize all parameters. Make sure that you save your important data to either floppy disk or card beforehand. See "Erase All Sequencer Data" on page 98 of the *Reference Guide*.

9) [GLOBAL] button

Press this button to select Global mode.

10) [DISK] button

Press this button to select Disk mode.

11) [BANK] button

Press this button to select banks in Program Play mode (A, B, GM) and Combination Play mode (A, B), and songs on a PROG/SEQ data card in Sequencer mode. If an optional PROG/SEQ data card is inserted, Program and Combination banks C and D can also be selected.

12) [COMPARE] button

Pressing this button allows you to compare the Program or Combination that you are currently editing with the original; COMPARE will appear on the LCD screen. Press the button again to return to the version you are editing; COMPARE will disappear. If you edit any parameters while the word COMPARE is shown on the LCD, then press [COMPARE] again, you lose the previous version.

13) [EDIT] button

Press this button to enter the corresponding edit mode for the current mode. For example, to select Program Edit mode, first select Program Play mode by pressing the [PROG] button, then press the [EDIT] button; EDIT will appear on the LCD screen. To cancel an edit mode, press another mode button.

14) VALUE slider

This slider is used to set parameter values and select parameter options. It can also be used to control effect parameters when set as the dynamic modulation control source.

15) [▲/YES] and [▼/NO] buttons

In Program Play mode and Combination Play mode, these buttons allow you to select Programs and Combinations, respectively.

These buttons can be used to set parameter values and select parameter options. Press the [▲/YES] button to increase values, and the [▼/NO] button to decrease them. Pressing and holding either button will change the selected parameter value rapidly.

By pressing both buttons simultaneously, you can reset the parameter to its original value, that is, the value before you edited it.

These buttons are also used when the X2/X3 requires a yes or no answer from you. For example, when the message "Are You Sure?" appears, press the [▲/YES] button to continue, or the [▼/NO] button to cancel.

16) LCD

This large, clear, and easy to read visual interface displays the current mode and any parameters related to that mode.

17) [CURSOR] buttons

These buttons are used to move the cursor around the LCD and select parameters.

To select an LCD screen, press and hold down the [←] or [→] cursor button. To select the next LCD screen to the left, press the [←] cursor button. To select the next LCD screen to the right, press the [→] button. To select the next or previous parameter group, use the [↑] and [↓] cursor buttons.

When another LCD screen is available to the left, "<" is shown. When another LCD screen is available to the right, ">" is shown. When LCD screens are available to both the left and right, "<>" is shown.

These buttons are also used to insert and delete characters when naming Programs, Combinations, and songs.

18) [10's HOLD/-] button

In Program Play mode and Combination Play mode, this button allows you to select Programs and Combinations with just one button press. Pressing the [10's HOLD/-] button will display a dot between the right-two digits on the LCD. At this time, pressing the number keypad changes the unit's digit of the Program or Combination number. Pressing the [▲/YES] and [▼/NO] buttons changes the ten's digit. For example, if you have selected Program 21 and you want to select Program 29, first press the [10's HOLD/-] button, then press number button [9]. Program 29 will be selected. Alternatively, to select Program 31, just press the [▲/YES] button. Program 31 will be selected. To cancel the 10's HOLD function, press the [10's HOLD/-] button.

This button is also used to enter negative parameter values. To make a negative value positive or vice versa, press the [10's HOLD/-] button. See "Setting Parameters" on page 19.

In Combination Edit mode, you can use this button to select Program banks when setting up Timbres.

When naming Programs, Combinations, and songs, this button can be used to select lowercase and uppercase characters. See "8B Program Rename" on page 33, "8B Combination Rename" on page 55, and "8A Rename Song" on page 150 of the *Reference Guide*.

19) Number keypad

This keypad allows you to select Programs and Combinations by entering the corresponding number. For example, to select Program 67 (presuming you are in Program Play mode), press number button [6], then [7].

The keypad can also be used to specify parameter values. See "Setting Parameters" on page 19. And to insert and delete characters when naming Programs, Combinations, and songs.

20) [ENTER] button

When you specify a parameter value using the number keypad, press this button to enter that value. If you do not press this button, the specified value will not be entered.

This button is also used when specifying parameter values using the keyboard.

21) Floppy Disk Drive

This is where you insert 3.5 inch 2DD type floppy disks. You can store Programs, Combinations, sequencer data, MIDI exclusive data, and SMF (Standard MIDI Files) on floppy disks. See "Disk Mode" on page 175 of the *Reference Guide*.

22) Joystick

The joystick allows real-time control of the following Program parameters: Pitch Bend, VDF Cutoff Frequency, VDF Modulation Intensity, Modulation Frequency and Intensity. See “5A Pitch1 Modulation” on page 27 and “6A After Touch & Joystick Control” on page 30 of the *Reference Guide*.

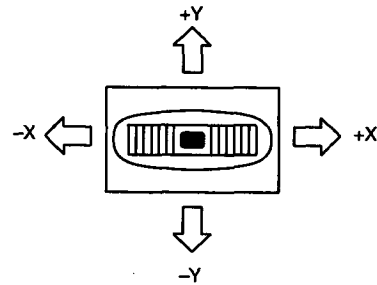

- ±X Pitch bend, VDF cutoff sweep
- +Y Pitch modulation depth (vibrato), speed
- Y VDF modulation depth (wow wow)

Rear Panel

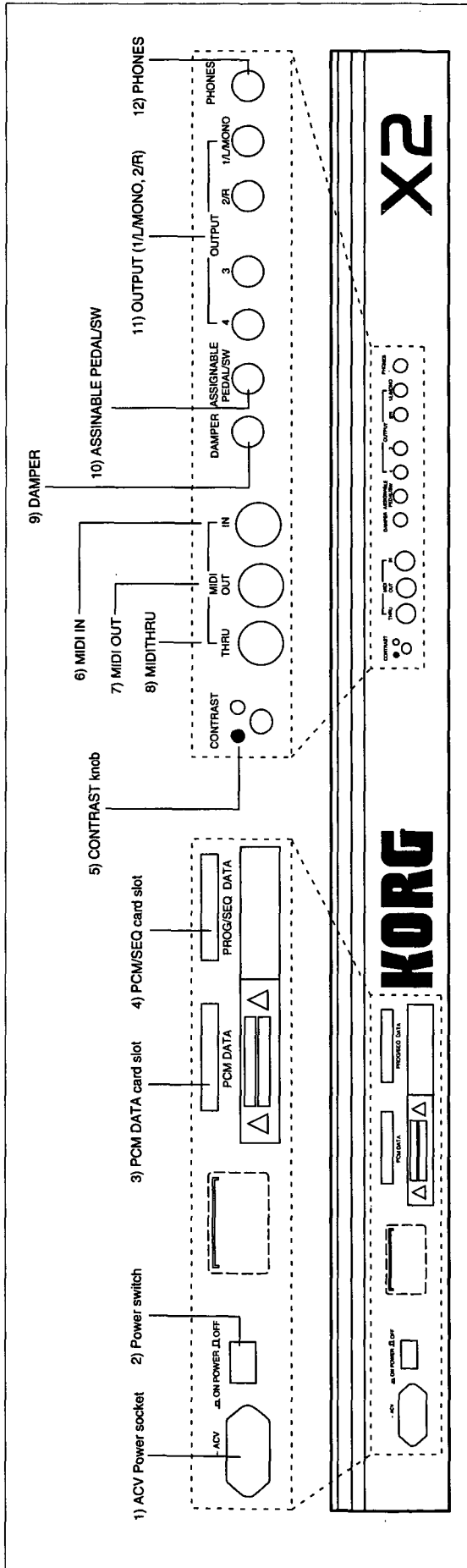

1) ACV Power socket

Connect the supplied power cord to this connection. Connect the other end of the power cord to a suitable AC receptacle.

2) POWER switch

This switch is used to power on and power off the X2/X3. Press once to power on; press again to power off.

3) PCM DATA card slot

Optional PCM data cards can be inserted here. These cards typically contain Multisounds and drum sounds, and they allow you to increase your library of Multisounds. See your Korg dealer for more details. See "PCM Data Cards" on page 197 of the *Reference Guide*.

4) PROG/SEQ DATA card slot

Optional PROG/SEQ data cards can be inserted here. These cards can be either RAM or ROM type cards.

ROM cards typically contain third-party Programs, Combinations, or both, and they allow you to expand your Program and Combination library.

RAM cards can be used to save Programs, Combinations, drum kits, global parameters, and sequencer data. See "PROG/SEQ Data Cards" on page 197 of the *Reference Guide*.

5) CONTRAST knob (X2 only)

This knob is used to adjust the LCD contrast. The LCD contrast varies depending on the angle that you look at it. Turning the knob clockwise makes the contrast darker, while turning it to counterclockwise makes it lighter. On the X3, contrast is adjusted in Global mode.

6) MIDI IN

The X2/X3 receives MIDI data via this connection. This could be connected to the MIDI OUT of a master keyboard, external sequencer, guitar controller, etc.

7) MIDI OUT

The X2/X3 outputs MIDI data via this connection. This could be connected to the MIDI IN of a synthesizer, external sequencer, drum machine, etc.

8) MIDI THRU

This connection outputs MIDI data received at the MIDI IN connection. This allows you to connect a number of MIDI devices in a daisy chain. Each device receives all the MIDI data, but only responds to data on the specified MIDI Channel.

If you want to connect more than three MIDI devices, we recommended that you use an optional MIDI THRU box. See your Korg dealer for more details.

9) DAMPER PEDAL

An optional Korg Damper pedal can be connected here. See "8C Damper Pedal Polarity" on page 174 of the *Reference Guide*.

10) ASSIGNABLE PEDAL/SW

An optional Korg PS-1 or PS-2 foot pedal or Korg EXP-2 volume pedal can be connected here. A pedal connected here can be set to perform one of many functions, such as selecting Programs and Combinations, starting and stopping the sequencer, or controlling the volume. See "8B Assignable Pedal/SW Setup" on page 173 of the *Reference Guide*.

11) OUTPUT 1/L/MONO, 2/R, 3, 4

These 1/4 inch phone jack connections should be connected to the inputs of a stereo amplifier, mixer, or cassette multitracker. If your amplifier is mono, use the 1/L/MONO connection. The X3 does not have outputs 3 and 4.

12) PHONES

A pair of stereo headphones can be connected here for private playing. The headphone signal is the same as that appearing at the 1/L/MONO and 2/R outputs. On the X2, depending on the chosen effect placement, you may not be able to hear sounds that are routed through buses C and D.

Chapter 2: Setting Up the X2/X3

Connecting Audio Equipment

Before making any connections, make sure that each piece of equipment is powered off, and that all volume controls are set to minimum.

1) Using the X2/X3 as the Only Sound Source

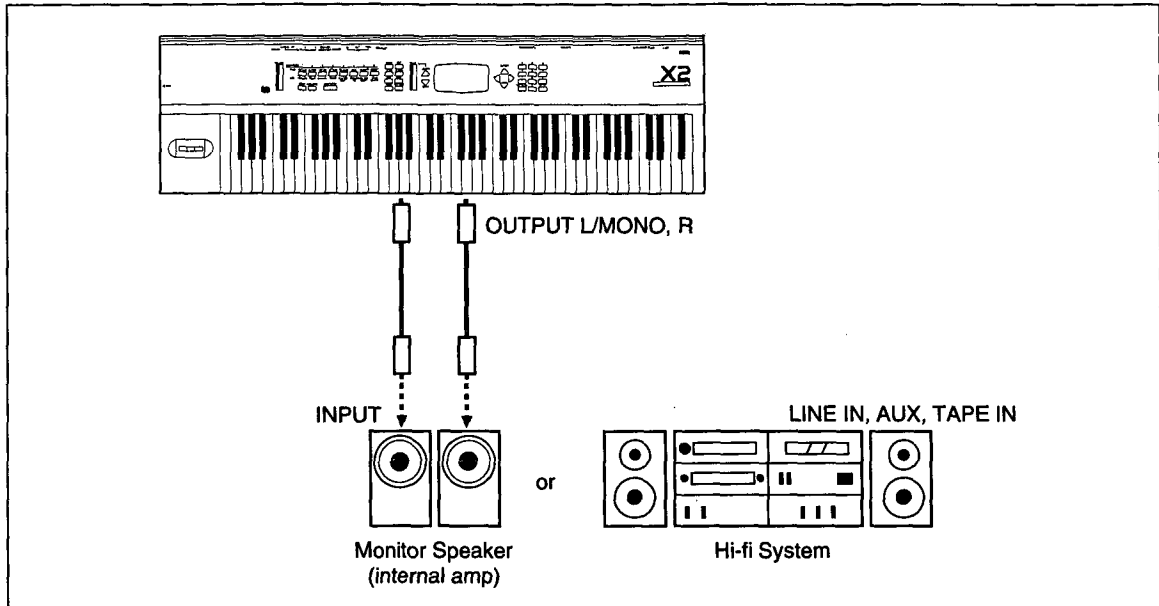

2) Using the X2/X3 in Combination with Other Sound Sources

When you use multiple tone generators, we recommend that you use a mixing console for easier operation. Some keyboard amplifiers have a few inputs for connecting a number of devices.

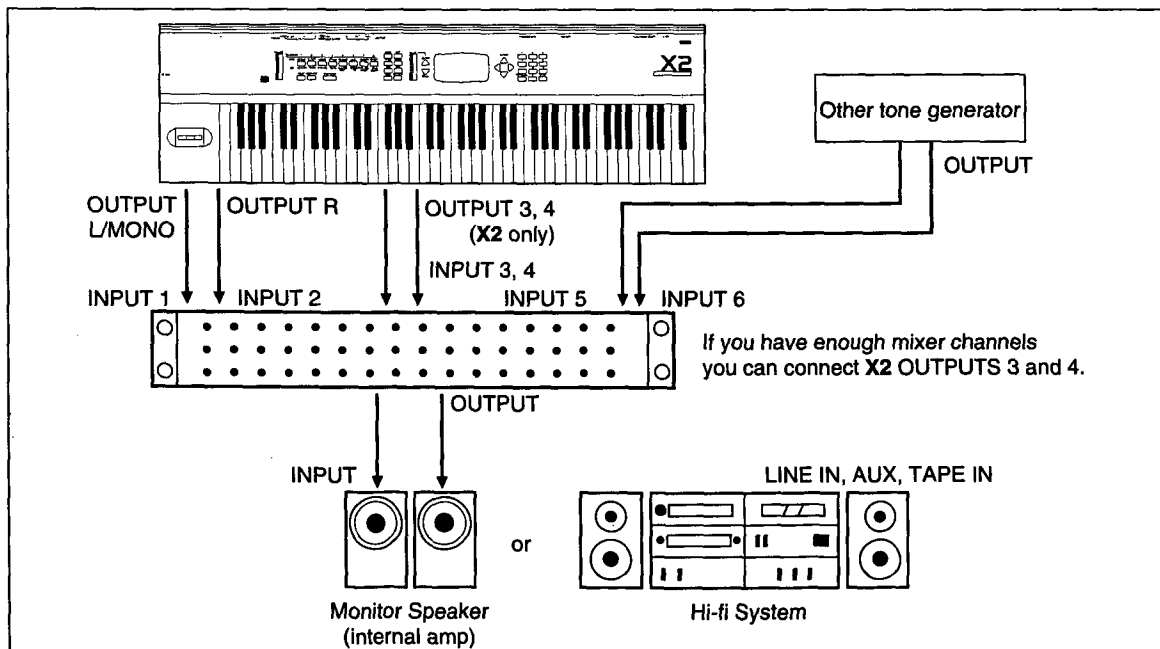

Note: Professional audio equipment such as the X2/X3 usually has a broad dynamic range. If you connect the X2/X3 to a domestic hi-fi system, be careful not to raise the volume level too high because you may damage the speakers.

Power On Procedure

When you have made all the necessary connections, press the [POWER] switch to power on the X2/X3. Then power on your mixing console (if applicable), and then the amplifier. At this point do not turn the power to the X2/X3 off and on, you may damage the speakers. After you turn on the power to the X2/X3, the LCD screen will display "X2 (or X3) MUSIC WORKSTATION" for a few seconds. Then Combination Play mode* will be selected.

Pressing the power switch when the X2/X3 is on will turn off the power to the X2/X3. At this time, all internal Programs, Combinations, drum kits, global parameters, and sequencer data are stored. Edits that have not been written, however, will be lost.

Do not power off the X2/X3 while the disk drive LED is lit, or when a "Loading" or "Saving" message is shown on the LCD. Otherwise, the disk, data, or both may be damaged.

* "Mode" refers to the X2/X3 operating status. The X2/X3 has eight modes. See "X2/X3 Modes" on page 4.

LCD Contrast

The LCD contrast has been set for optimum readability. However, depending on the temperature and lighting conditions, you may need to adjust it to maintain good readability.

To adjust the contrast on the X2, use the CONTRAST knob on the rear panel. For the X3, press the [GLOBAL] button to select Global mode, press function button [8], then use the VALUE slider or the [▲/YES] and [▼/NO] buttons.

Listening to the Demo Song

After completing the audio connections, you can listen to the demo song that has been loaded into the X2/X3 sequencer. Raise the volume level to about half way, and raise the volume level of the mixing console and amplifier slightly. Press the [START/STOP] button to start the demo song. Press the [START/STOP] button again to stop the demo song. Adjust the volume level of the mixing console and amplifier while listening to the song. Enjoy the wonderful sound of the Korg X2/X3.

If you hear no sound, check all the connections. Try connecting a pair of headphones to the PHONES output. If you can hear the demo song in the headphones, the problem must be a connection or device further down the line.

MIDI Connections

After listening to the demo song to check the audio connections, you're ready to make the MIDI connections. The X2/X3 is an integrated music workstation, allowing you to create high-quality music. Furthermore, it has a wide-range keyboard, a sequencer comparable with a stand-alone sequencer, and it also works as an excellent master keyboard in a large-scale MIDI system.

1) Connecting to a Tone Generator (Synthesizer)

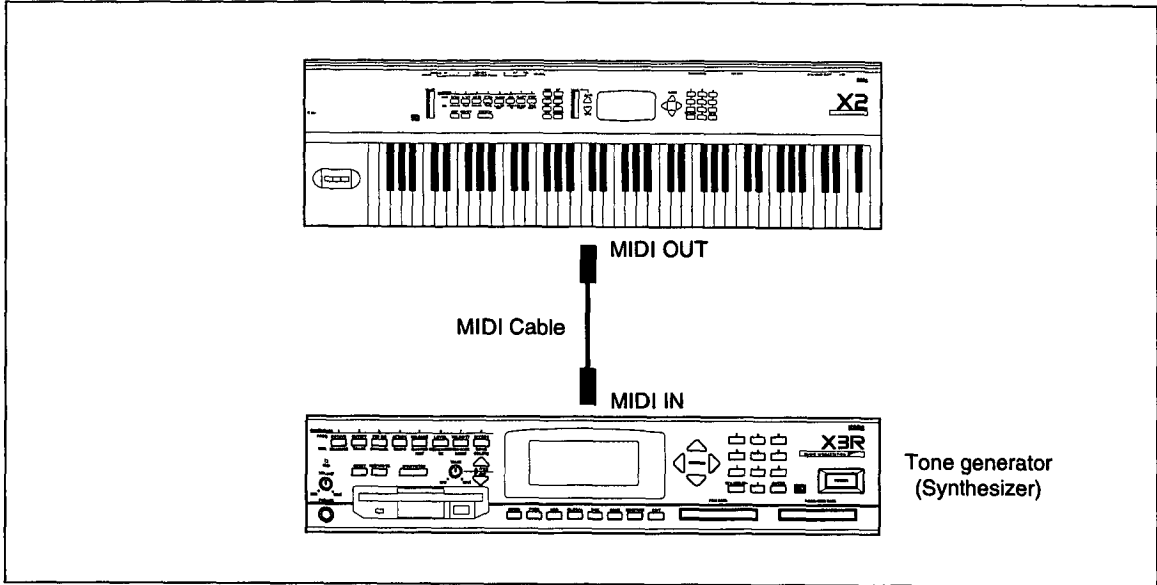

2) Connecting to a Tone Generator (Synthesizer) and MIDI Sequencer

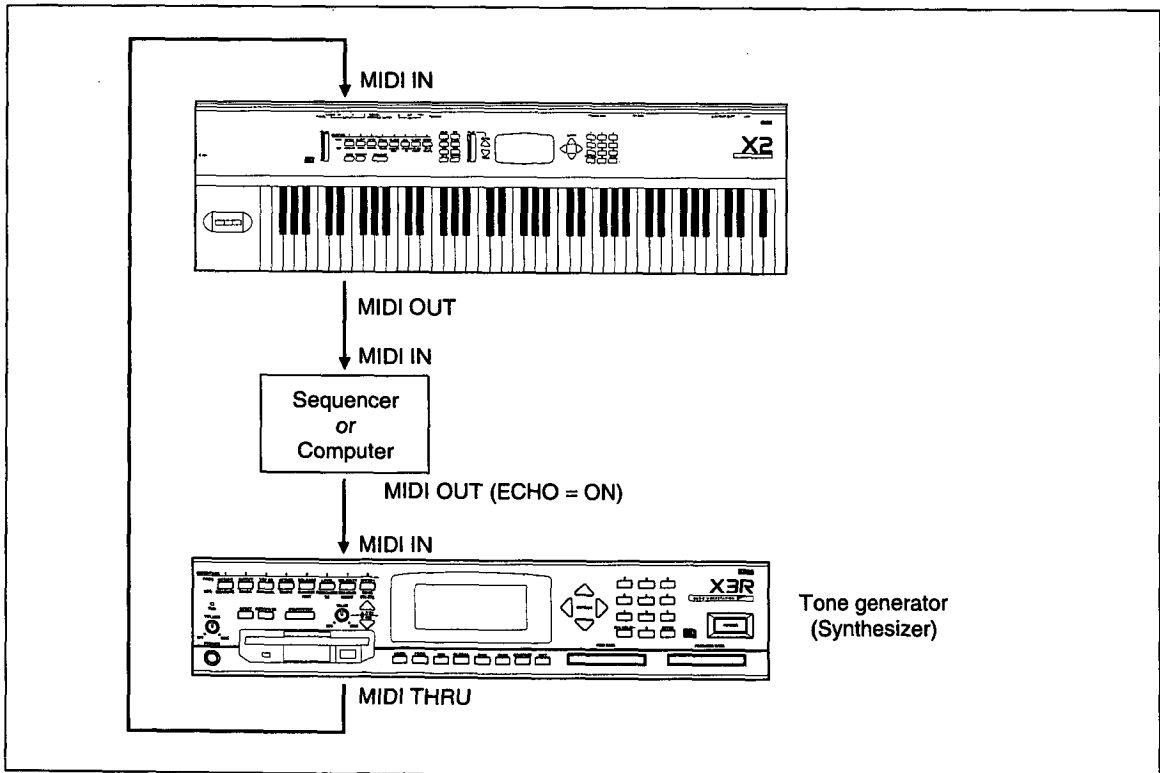

3) Connecting to a MIDI Sequencer

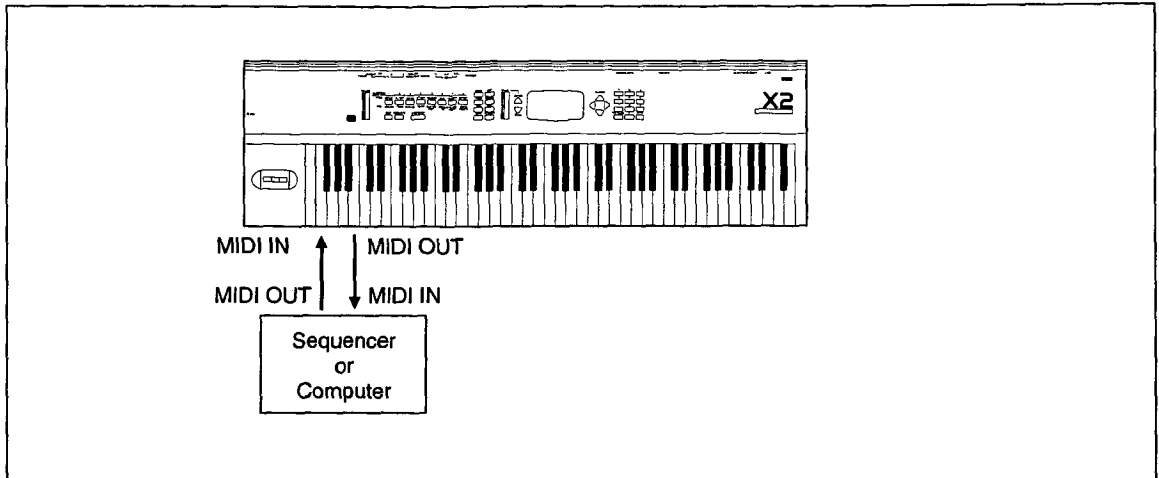

Do not connect more than three MIDI devices via MIDI THRU, because MIDI signals may be delayed. We recommend you use a MIDI patch bay to configure a reliable and efficient system.

4) Using a MIDI Patchbay

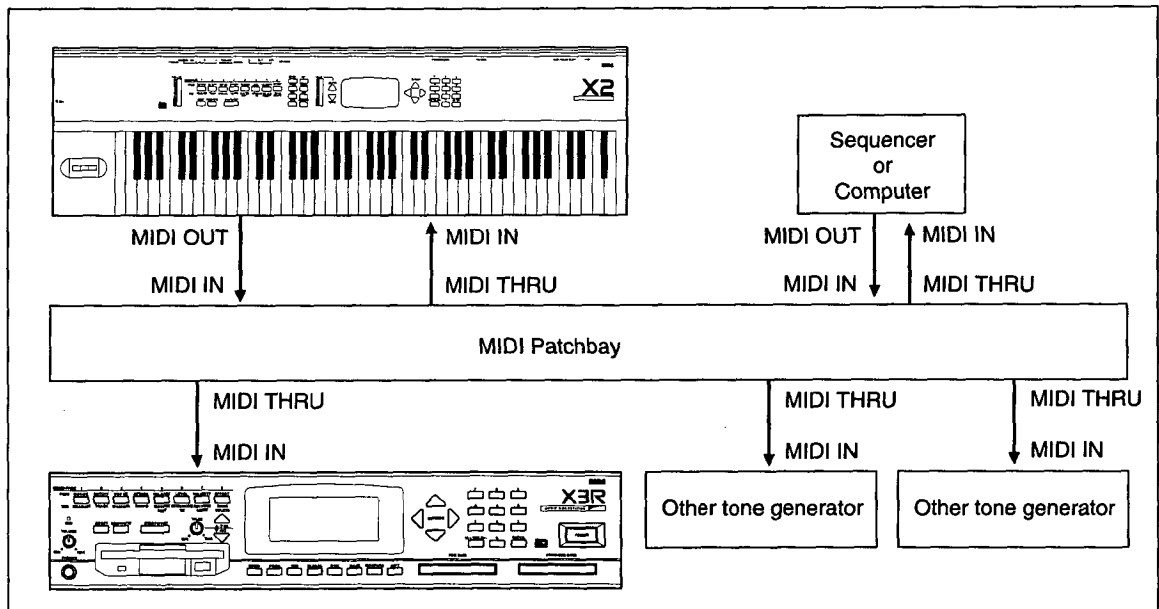

Note: If a tone generator produces no sound, it may be due to a faulty MIDI cable. Use only high-quality MIDI cables, and make sure all connections are complete.

Chapter 3: Getting Around the X2/X3

The LCD

This section explains the various characters and symbols that appear on the X2/X3 LCD.

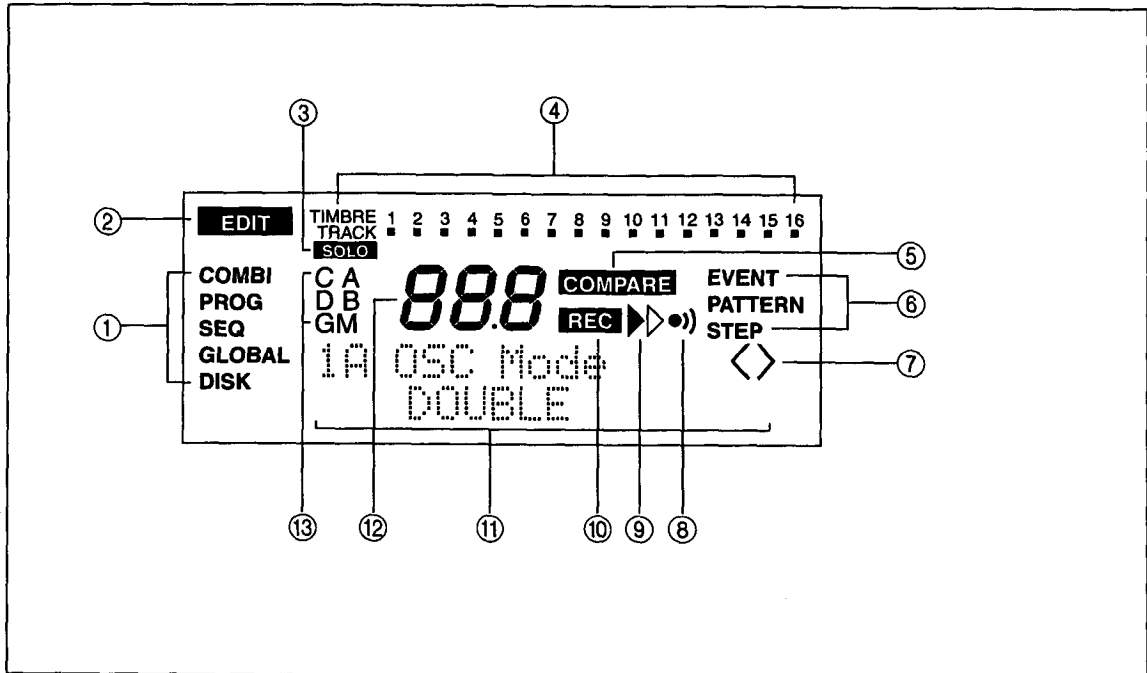

1) Modes

These indicate the current mode.

2) EDIT

This indicates that the current mode is an Edit mode.

3) SOLO

In Combination Play mode, this indicates that a Timbre is soloed. In Sequencer modes, it indicates that a track is soloed.

4) TIMBRE, TRACK

In Program Play mode, the numbers 1 to 16 are displayed. A flashing number indicates the Global MIDI Channel setting. When MIDI Note On/Off messages are received, a box below the corresponding MIDI Channel number flashes.

In Combination Play mode, the numbers 1 to 8 correspond to Timbres 1 to 8. When MIDI messages are received, a box below the corresponding Timbre number flashes. No number indicates that a Timbre is turned off.

In Sequencer mode, numbers 1 to 16 correspond to tracks 1 to 16. A flashing number indicates the currently selected track. When MIDI messages are received, a box below the corresponding track number flashes.

5) COMPARE

This indicates that the Compare function is active.

6) EVENT, PATTERN, STEP

In Sequencer Edit mode, EVENT appears when using event related LCD screens, PATTERN appears when using pattern related LCD screens, and STEP appears when using step related LCD screens.

7) < >

These indicate that other LCD screens are available within the current group.

When another LCD screen is available to the left, "<" is shown. When another LCD screen is available to the right, ">" is shown. When LCD screens are available to both the left and right, "<>" is shown.

8) Metronome

This indicates that the metronome is on.

9) Beat Indicators

These indicate the beat.

- ▶ This indicates the first beat of a measure.
- ▶ This indicates the other beats.

10) REC

This indicates that recording is in progress.

11) Character Display

Program names, Combination names, song names, parameters, etc., are displayed on these two lines. The top line can display 14 characters, and the bottom line, 16 characters.

Most of the LCD screens in the X2/X3 manuals show just these two lines.

12) Three Large Digits

In Program Play mode and Combination Play mode, these indicate the number of the currently selected Program or Combination, respectively. In Sequencer modes, they indicate the current song measure.

The dot between the right-two digits indicates that the [10's HOLD/-] button is active.

13) Bank/Measure

In Program Play mode, these indicate the current Program bank. A and B are internal RAM banks, C and D are PROG/SEQ data card banks, and GM is an internal ROM bank.

In Combination Play mode, these indicate the current Combination bank. A and B are internal RAM banks, and C and D are PROG/SEQ data card banks.

In Sequencer modes, the letter M indicates that the three large digits are displaying measure numbers.

Selecting LCD Screens

X2/X3 functions are organized into modes: Program Edit mode, Combination Edit mode, Sequencer Edit mode, Disk mode, and Global mode. In these modes, LCD screens are identified alphanumerically. For example, in Program Edit mode the INIT PROG function is located on LCD screen 8E, as shown below. To select LCD screen 8E, press function button [8], then press the [↑] cursor button four times.

8E INIT PROG	OK?
--------------	-----

For some functions, there may be one, two, three, or more LCD screens available. These are called LCD screen groups. If more LCD screens are available, left or right angle brackets "<>" are shown on the right-hand side of the LCD. In this case, use the [←] and [→] cursor buttons to select the other screens.

On the X2/X3, LCD screens in a group all display the same number (e.g. 1A or 3E). In the X2/X3 manuals, however, LCD screens in a group are numbered as 1A-1, 1A-2, etc. To select the first LCD screen in a group, press the corresponding function button. For example to select LCD screen 4A-1, press function button [4]. To select the other LCD screens in the group, use the [←] and [→] cursor buttons. For example, to select LCD screen 4A-3, first press function button [4], then press the [→] cursor button twice.

To select other LCD screen groups, press the corresponding function button, or use the [↑] and [↓] cursor buttons. Basically, LCD screens are organized in a grid, as shown below.

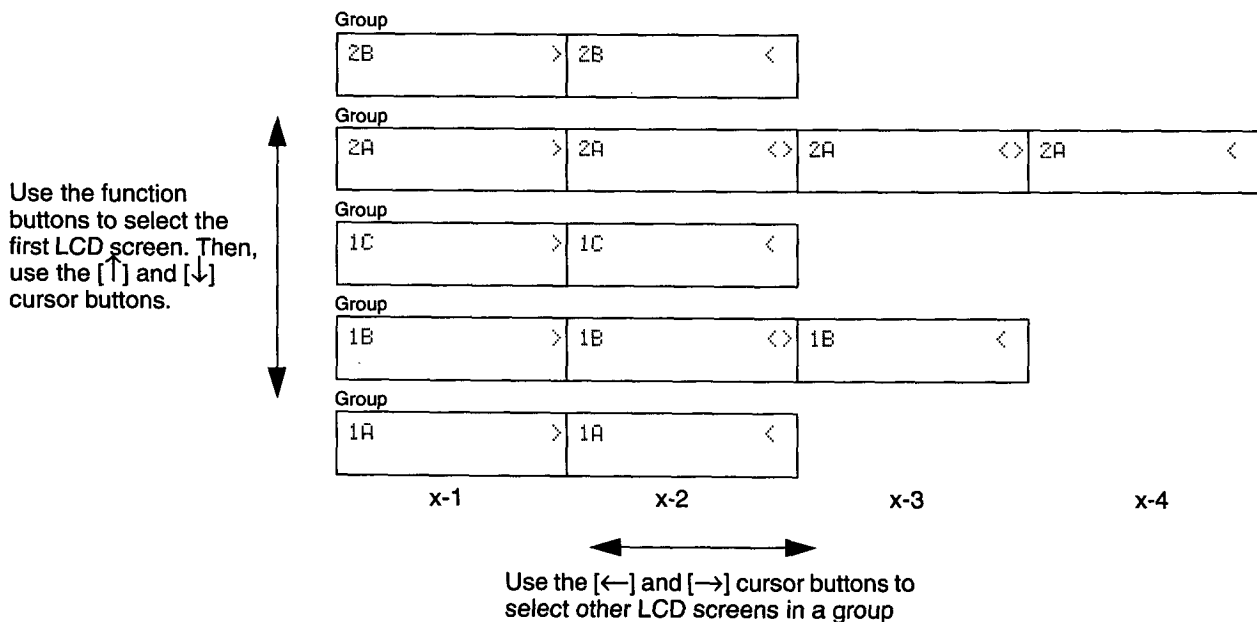

Selecting Parameters

On most of the LCD screens, a number of parameter values are displayed simultaneously. The currently selected parameter is the one that is flashing. To select other parameters, use the [←] and [→] cursor buttons.

Setting Parameters

There are four ways in which you can set parameters:

- Using the VALUE slider
- Using the [▲/YES] and [▼/NO] buttons
- Using the number keypad
- Using a MIDI keyboard (works for a few functions only)

VALUE slider: select the parameter that you want to adjust, then adjust the slider. Slide it upward to increase a value, and downward to decrease it.

[▲/YES] and [▼/NO] buttons: select the parameter that you want to adjust, then press the [▲/YES] button to increase it, or the [▼/NO] button to decrease it.

Pressing both buttons simultaneously while editing allows you to reset a parameter to its original value.

Number keypad: select the parameter that you want to adjust, enter the value, then press the [ENTER] button. For example, to specify a value of 58, press the [5] button, the [8] button, then the [ENTER] button.

To enter a negative value, or change a value from positive to negative or vice versa, press the [10's HOLD/-] button.

Note: *If you specify a value that is outside the selected parameter's range, the highest or lowest available value for that parameter will be selected.*

A MIDI Keyboard: connected to the X2/X3's MIDI IN can be used to specify note values for parameters such as Key Window, which accept note value input.

When editing drum kits in Global mode, holding down the [ENTER] button and pressing a key selects the drum index assigned to the that key. Note that when the transpose function is active, these key positions are different.

Comparing While Editing

[COMPARE] button: while editing Programs and Combinations, press the [COMPARE] button to listen to the original version. The word "COMPARE" will appear on the LCD. Press the [COMPARE] button again to return to the edited version.

[▲/YES] & [▼/NO] buttons: to reset a parameter value to the value that it was when you first selected it, press the [▲/YES] & [▼/NO] buttons simultaneously.

Useful Notes

Front Panel Colors: on the X2/X3 front panel, functions for Sequencer mode are printed in green, and functions for Program Play mode are printed in white.

Effects: in Program Edit mode, Combination Edit mode, and Sequencer Edit mode, you can set up the effects by pressing function button [7].

Quick Write: in Program Play mode, Program Edit mode, Combination Play mode, and Combination Edit mode, you can write to memory at anytime by pressing the [REC/WRITE] button, then the [▲/YES] button.

MIDI Notes

The X2/X3 responds to incoming MIDI notes from C-1 to G9 (MIDI Note numbers 0 to 127). However, some Programs may not produce any sound at the top end of the range.

The following table shows how MIDI Note numbers correspond to keyboard notes.

Note	C-1	C0	C1	C2	C3	C4	C5	C6	C7	C8	C9	G9
MIDI Note Number	0	12	24	36	48	60	72	84	96	108	120	127

Chapter 4: Program Play Tutorial

The X2/X3 has two types of sounds: Programs and Combinations. Programs are the basic sounds that you can play. Combinations consist of a number of Programs, and are used to create more complex tone colors, useful for live performance and sequencer work.

First we'll listen to some Programs.

- 1) Press the [PROG] button to enter Program Play mode. The following illustration shows the location of the [PROG] button.

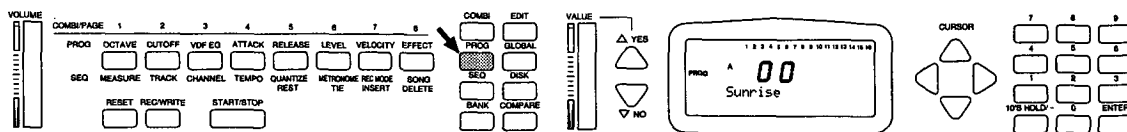

- 2) Play your MIDI keyboard or send MIDI Note data from your sequencer. The X2/X3 will produce sound.

Note: If no sound is heard, check the Local ON/OFF setting, then check to see if the MIDI keyboard or sequencer is sending data on the same MIDI channel as the X2/X3's Global MIDI Channel.

Changing the X2/X3 Global MIDI Channel

In Program Play mode, the X2/X3 recognizes MIDI Note data on the Global MIDI Channel. Initially, this is set to MIDI Channel 1. If necessary, change the MIDI Channel on the MIDI keyboard or sequencer. To change the X2/X3 Global MIDI Channel, press the [GLOBAL] button to enter Global mode, then press function button [3] (or press the [↑] cursor button four times) to select LCD screen 3A. Now that the MIDI Channel parameter (CH) has been selected, use the VALUE slider or the [▲/YES] and [▼/NO] buttons to set it. The following illustration shows the locations of the [GLOBAL] button and function button [3].

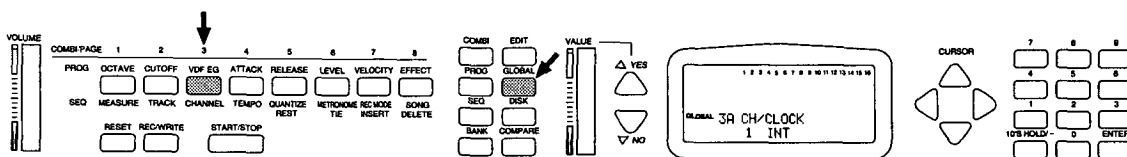

Selecting Banks & Programs

Selecting Banks

Programs are stored in banks A, B, and GM. If an optional PROG/SEQ card is inserted, Programs from card banks C and D can also be selected. You can select a Bank by pressing the [BANK] button. Bank GM contains preset Programs conforming to GM. You cannot write any data into this bank, however, you can edit a GM Program, then save it to another bank. The following illustration shows the location of the [BANK] button.

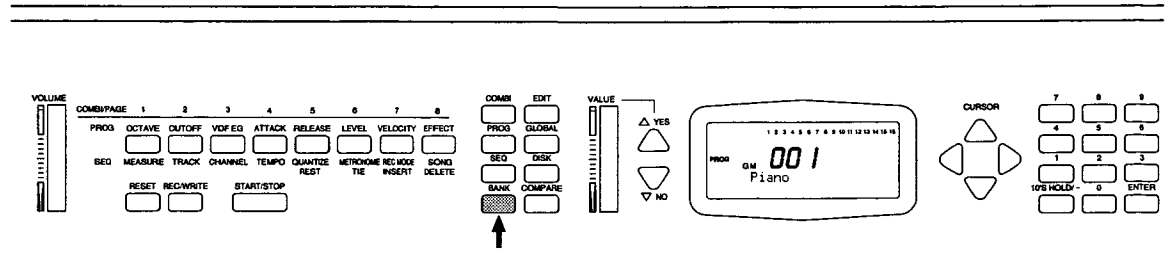

Selecting Programs

Programs can be selected using the X2/X3 number keypad, the [▲/YES] and [▼/NO] buttons, or by sending a MIDI Program Change message from a MIDI keyboard or sequencer.

You can select Programs directly by entering the Program number via the number keypad. With the [10's HOLD/-] button, Programs can also be selected with just one button press.

Pressing the [10's HOLD/-] button will display a dot between the right-two digits on the LCD. At this time, pressing the number keypad changes the unit's digit of the Program number. Pressing the [▲/YES] and [▼/NO] buttons changes the ten's digit. This allows you to select Programs easily. The following illustration shows the location of the [10's HOLD/-] button.

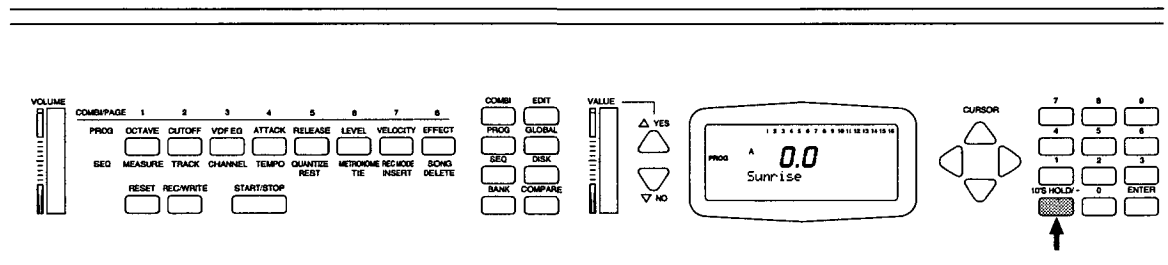

Pressing the [▲/YES] and [▼/NO] buttons selects Programs sequentially. The following illustration shows the location of the [▲/YES] and [▼/NO] buttons.

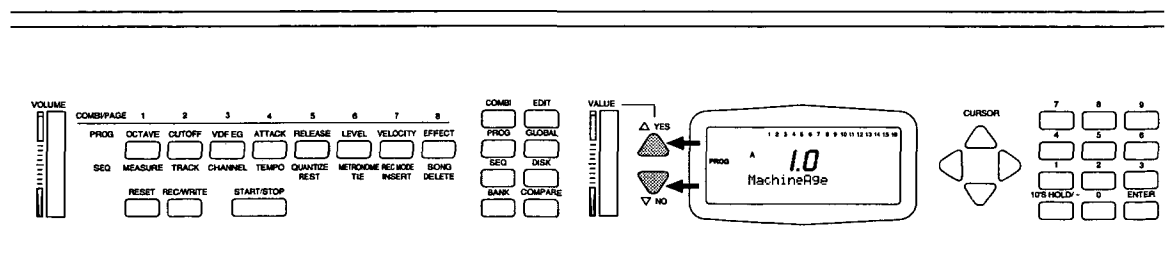

Note: The 10's HOLD function is canceled when the X2/X3 receives a MIDI Program Change message. MIDI Program Change numbers 100–127 are interpreted as 00–27 for all banks except GM.

Editing in Program Play Mode

Comprehensive Program editing is normally carried out in Program Edit mode. However, you can edit some Program parameters in Program Play mode. These parameters include: 1) Oscillator Octave, 2) Filter Cutoff Frequency, 3) Filter Envelope Intensity, 4) Amplitude Envelope Attack, 5) Amplitude and Filter Envelope Release, 6) Amplitude Level, 7) Velocity Depth, and 8) Effect Depth. These parameters allow you to make both subtle and drastic changes to a Program while performing.

The above parameters are selected using the function buttons. Parameter names are printed in white above the function buttons. Once selected, use the VALUE slider, the [▲/YES] and [▼/NO] buttons, or the number keypad to adjust the parameter. Parameters are adjusted from -10 to +10. The resultant parameter value is shown on the bottom line of the LCD. The following illustration shows the location of the function buttons.

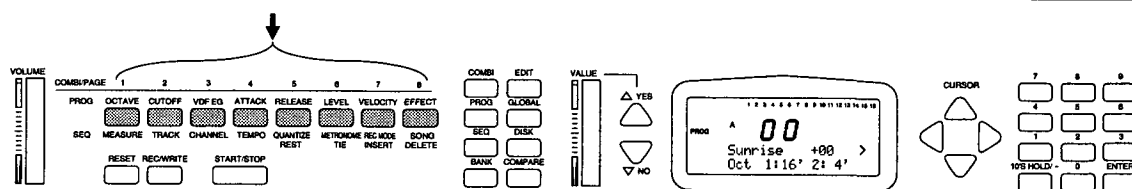

If you select another Program without saving first, your edits will be lost. If you want to save them, you must write the Program to memory. To do this, press the [REC/WRITE] button. An "Are You Sure?" message will appear. Press the [▲/YES] button to write the Program, or the [▼/NO] button to cancel. Note that if you write, you will overwrite the Program that already exists at that number. To write the Program to a different Program number or change its name, you need to enter Program Edit mode. See "8A Program Write" on page 32 of the *Reference Guide*.

Chapter 5: Combination Play Tutorial

Combinations consist of a number of Programs, and create tone colors more complex than those possible using Programs alone. They are ideal for live performance and sequencer work.

- 1) To enter Combination Play mode, press the [COMBI] button. The following illustration shows the location of the [COMBI] button.

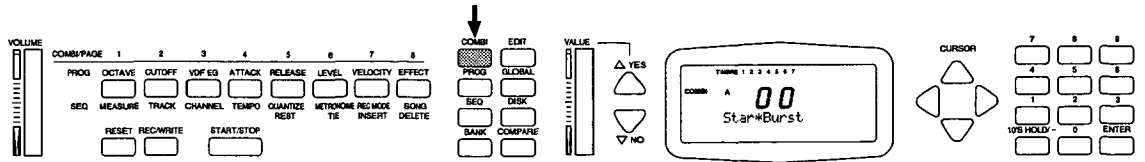

Before you start playing, let's take a look at Combination structure and Timbre MIDI Channels.

Combination Structure

Combinations can consist of up to eight Programs. In a Combination, Programs are handled as Timbres. In Combination Play mode, the word TIMBRE and several numbers are displayed at the top of the LCD. The numbers indicate which of the available eight Timbres are actually being used in the selected Combination. On the LCD shown below, Combination A00 "Star*Burst" is selected, and numbers 1 to 7 are displayed. This means that the Star*Burst Combination is using Timbres 1 to 7.

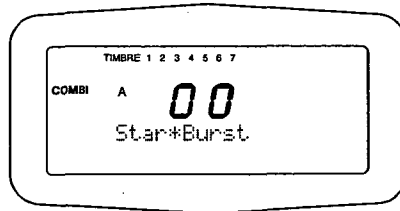

In Combination Play mode, function buttons [1] to [8] correspond to Timbres 1 to 8. Pressing a function button will display the name of the Program assigned to the corresponding Timbre. Double-pressing a function button quickly activates the Solo function. This allows you to listen to Timbres individually. Double-press the respective function button again to cancel Solo. The following illustration shows the location of the function buttons.

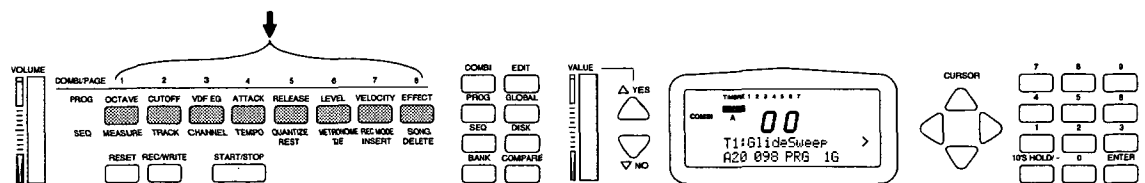

Timbre MIDI Channels

In Combination Play mode, Timbres can be assigned to different MIDI Channels, so each Timbre will respond only to MIDI Note data on its assigned MIDI Channel. Initially, all Timbres are assigned to MIDI Channel 1. If necessary, change the MIDI Channel on the MIDI keyboard or sequencer. To set a Timbre's MIDI Channel, press a function button to select the Timbre, then press the [→] cursor button three times. "MIDI CHANNEL" will flash on the LCD. Use the VALUE slider, the [▲/YES] and [▼/NO] buttons, or the number keypad to select a MIDI Channel. The following illustration shows the location of the function buttons and the [→] cursor button.

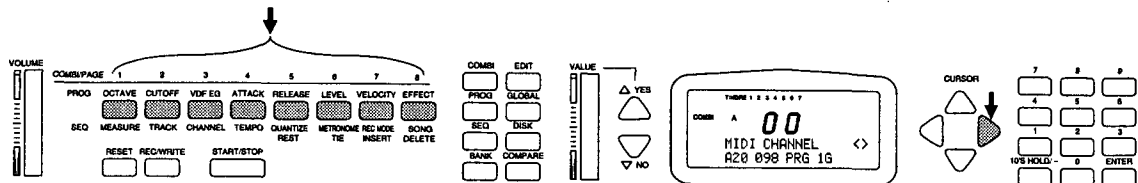

When a Timbre is actually playing, i.e., responding to incoming MIDI Note data, a small box appears under the corresponding Timbre number on the top line of the LCD. This makes it easy to tell which Timbres are actually sounding.

Playing Combinations

Now that we've looked at Combination structure and Timbre MIDI Channels, let's play a Combination. Play your MIDI keyboard or send MIDI Note data from your sequencer. The X2/X3 will produce sound.

Note: If no sound is heard, check to see if the MIDI keyboard or sequencer is sending data on the MIDI channels used by the Combination Timbres.

Selecting Banks & Combinations

Selecting Banks

Combinations are stored in banks A and B. You can select a Bank by pressing the [BANK] button. The following illustration shows the location of the [BANK] button.

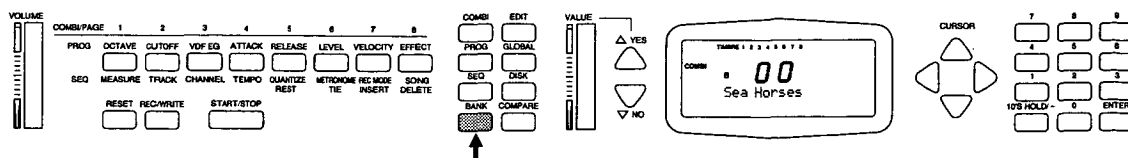

Selecting Combinations

Combinations can be selected using the X2/X3 number keypad, the [▲/YES] and [▼/NO] buttons, or by sending a MIDI Program Change message from a MIDI keyboard or sequencer.

You can select Combinations directly by entering the Combination number via the number keypad. With the [10's HOLD/-] button, Combinations can also be selected with just one button press.

Pressing the [10's HOLD/-] button will display a dot between the right-two digits on the LCD. At this time, pressing the number keypad changes the unit's digit of the Combination number. Pressing the [▲/YES] and [▼/NO] buttons changes the ten's digit. This allows you to select Combinations easily. The following illustration shows the location of the [10's HOLD/-] button.

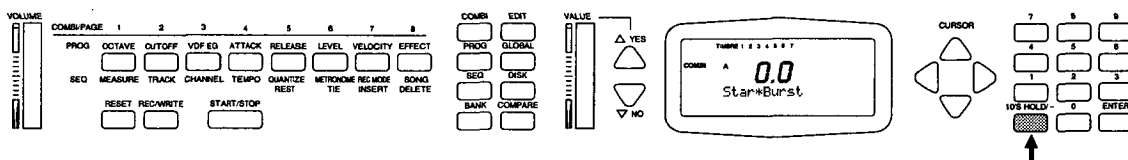

Pressing the [▲/YES] and [▼/NO] buttons selects Combinations sequentially. The following illustration shows the location of the [▲/YES] and [▼/NO] buttons.

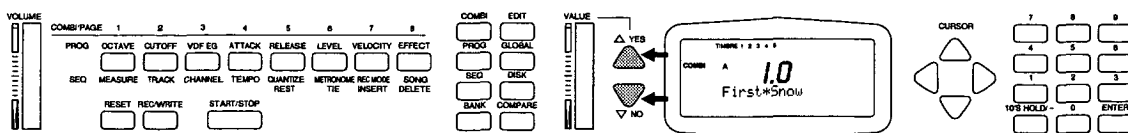

Note: The 10's HOLD function is canceled when the X2/X3 receives a MIDI Program Change message. MIDI Program Change numbers 100–127 are interpreted as 00–27.

Editing in Combination Play Mode

Comprehensive Combination editing is normally carried out in Combination Edit mode. However, you can edit some Combination parameters in Combination Play mode. These parameters include: 1) Program to Timbre assignment, 2) Level, 3) Pan, and 4) MIDI Channel.

These parameters appear on the bottom line of the LCD when a function button is pressed. Remember that function buttons [1] to [8] correspond to Timbres [1] to [8]. Use the [←] and [→] cursor buttons to select a parameter. The name of the selected parameter flashes on the LCD. Once selected, use the VALUE slider, the [▲/YES] and [▼/NO] buttons, or the number keypad to adjust it. The following illustration shows the location of the function buttons and the [←] and [→] cursor buttons.

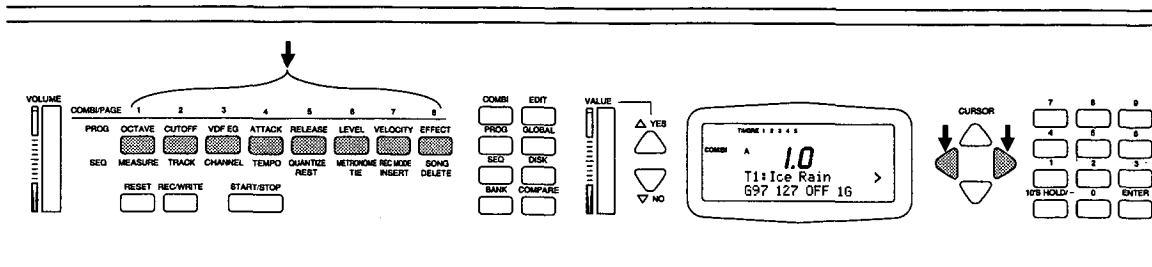

If you select another Combination without saving first, your edits will be lost. If you want to save them, you must write the Combination to memory. To do this, press the [REC/WRITE] button. An “Are You Sure?” message will appear. Press the [▲/YES] button to write the Combination, or the [▼/NO] button to cancel. Note that if you write, you will overwrite the Combination that already exists at that number. To write the Combination to a different Combination number or change its name, you need to enter Combination Edit mode. See “8A Combination Write” on page 54 of the *Reference Guide*.

Chapter 6: Combination Edit Tutorial

In Combination Edit mode you can edit existing Combinations and create your own originals. To enter Combination Edit mode, press the [COMBI] button, then the [EDIT] button. For details about setting parameters, see “Setting Parameters” on page 19. Before we start editing, let’s take a look at the various types of Combinations that are available. Understanding the different types and their differences will help you when making Combinations for specific purposes.

Combination Types

Layered

When Timbres are layered together, they produce a thick and complex sounding Combination. Layered sound qualities cannot be achieved by individual Programs alone.

Split

Timbres can be set to respond to a specific range of MIDI Notes. This range is called a Key Window, and it allows you to split a keyboard into several sections, with each section used to play a different Timbre. This allows you, for example, to play a different Program with each hand.

Velocity Switch

Timbres can be set to respond to a specific range of MIDI Note velocities. In this way, only notes within a certain velocity range will cause a Timbre to sound. This range is called a Velocity Window, and allows velocity controlled switching from one Timbre to another as the note velocity increases or decreases.

Velocity Layer

This is similar to a Velocity Switch Combination, although, rather than switch between Timbres, they are gradually layered together as the note velocity increases or decreases. This is achieved by overlapping the Timbre Velocity Windows.

By using the Key Window and Velocity Window parameters together, Combinations with split and switch Timbres can be created.

Editing Combinations

In this tutorial we'll edit Combination A00 Star*Burst. This Combination has a keyboard split point set at note C4. So different sounds are produced by notes above and below the C4 split point. In addition, a Timbre with Velocity Window settings and a Key Window range below C4 is used. This creates a sound with a rising pitch as notes below C4 are played stronger.

Combinations can consist of up to eight Timbres. The Timbre Mode parameter on LCD screen 1B is where Timbres are turned on and off. Press the [↑] cursor button once to select LCD screen 1B. For the Star*Burst Combination, Timbres 1 to 7 are set to INT, and Timbre 8 is set to OFF. Use the VALUE slider or the [▲/YES] and [▼/NO] buttons to set the Timbres.

Key Window

To set up layer and split type Combinations, the Timbre parameter Key Window is used to specify a range of MIDI Notes. Press function button [4] or use the [↑] and [↓] cursor buttons to select LCD screen 4A. Use the Key Window Top (KW TOP) parameter to set the highest note in the range. Use the [←] and [→] cursor buttons to select the other Timbres. Then, press the [↑] cursor button to select LCD screen 4B. Use the Key Window Bottom (KW BTM) parameter to set the lowest note in the range. For Star*Burst, the highest note for Timbres 1 and 4 is C4. The highest note for Timbres 6 and 7 is B3. And the lowest note for Timbres 2 and 5 is C#4. The following illustration shows the location of function button [4] and LCD screen 4A.

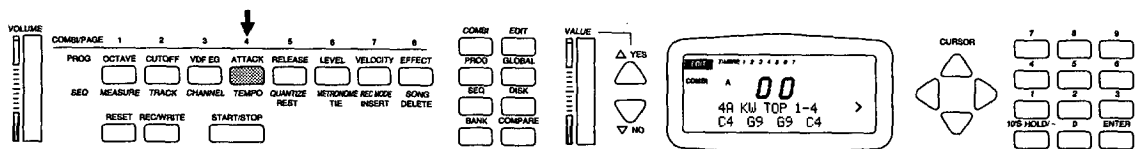

Velocity Window

Just like the Key Window parameters, the Velocity Window parameters also need to be set to use layer and split type Combinations. The Velocity Window parameter is used to specify the range of MIDI note velocities that a Timbre responds to. Select LCD screen 4C. Use the Velocity Window Top (VW TOP) parameter to set the highest note velocity in the range. Use the [←] and [→] cursor buttons to select the other Timbres. Then, press the [↑] cursor button to select LCD screen 4D. Use the Velocity Window Bottom (VW BTM) parameter to set the lowest note velocity in the range. For Star*Burst, the lowest note velocity for Timbre 1 is set to 68.

Using the X2/X3 as a MultiTimbral Tone Generator

In Combination mode, the X2/X3 can be used as an 8-part multi-timbral tone generator with an external MIDI sequencer. Timbres can be assigned to individual MIDI Channels that correspond with the MIDI Channel-to-track assignments on the external sequencer. To set the MIDI Channel for a Timbre, press function button [3] or use the [↑] and [↓] cursor buttons to select LCD screen 3A. The following illustration shows the location of function button [3] and LCD screen 3A.

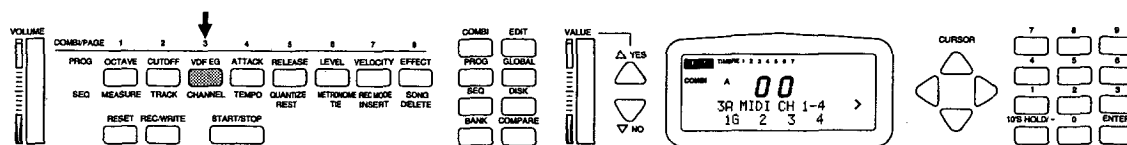

Timbre Programs can be selected by sending MIDI Program Change messages from the sequencer. Most sequencers allow you to record MIDI Program Change messages into tracks. This ensures that the correct Programs are selected for each Timbre. It also allows you to select other Programs during song playback. The MIDI Program Change Filters on LCD screen 6A must be set to "E" for this to work. If set to "D", a Timbre will ignore MIDI Program Change messages. The following illustration shows LCD screen 6A and the location of function button [6] that is used to access it.

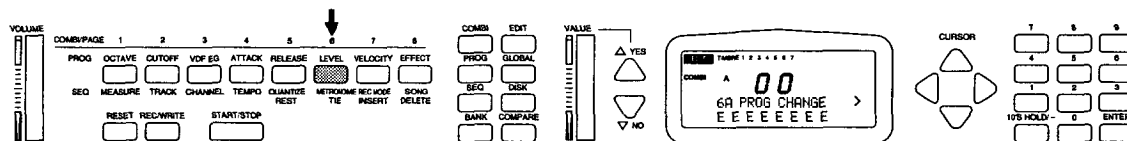

By assigning the same MIDI Channel to Timbres with different Key Window and Velocity Window settings, layer and split techniques can be applied easily to sequencer data.

Although you can use the X2/X3 in Sequencer mode to provide 16-part multitimbrality, if 8-part multitimbrality is sufficient, we recommend that you use Combination Play mode, in which you can select Combinations using MIDI Program Change messages. However, if you want to use Sequencer mode for multitimbral work, see page 93 of the *Reference Guide*.

Saving Combinations

If you select another Combination without saving first, your edits will be lost. If you want to save them, you must write the Combination to memory. To do this, press the [REC/WRITE] button. An "Are You Sure?" message will appear. Press the [▲/YES] button to write the Combination, or the [▼/NO] button to cancel. Note that if you write, you will overwrite the Combination that already exists with that number. To write the Combination to a different Combination number or change its name, you need to enter Combination Edit mode. See "8A Combination Write" on page 54 of the *Reference Guide*.

Chapter 7: Effects Tutorial

Two of the X2/X3's main features are its built-in digital multi-effects processors. This tutorial describes the different effect types and how to use them. Effects can be selected on LCD screens 7A and 7C in Program Edit mode, Combination Edit mode, and Sequencer Edit mode.

What is a Multi-Effects Processor?

An effects processor is used to add effects to sound that has been converted into an electronic signal, such as the sound from a synthesizer, guitar, or microphone. For example, reverb and delay type effects can be used to add acoustic ambience and echoes to electronic instruments in the recording studio. Equalizers can be used to produce subtle or drastic tonal changes to a sound. These various effects are usually produced by a number of dedicated devices. However, multi-effects processors, like those in the X2/X3, can produce all these effects. The X2/X3 reverb effects allow you to simulate the acoustic ambience from a small hall to that of the grand canyon. Most of the other effects can be used as part of the sound creation process itself, further increasing the possibilities for original sound creation.

Effect Types

The X2/X3's 47 effects are based on 12 primary effects. In this section we look at each of these primary effects in detail.

Effects that Add Acoustic Ambience to a Sound

Effects that add a sense of Acoustic Ambience to a Sound are typically called reverb.

1) Reverb

Sounds exhibit a wide variety of reverberations, depending on the size of the surrounding acoustic environment and the materials used in nearby walls, ceiling, etc. Reverb is used to simulate these naturally occurring reverberations for dry sounds. Dry sound refers to the original sound without effects. Sounds with effects are sometimes said to be wet. The X2/X3 features nine types of reverb effects—from 1:Hall through to 9:Spring. Each reverb effect simulates the acoustic ambience of a different environment space.

Let's look at the nature of reverberations. Imagine making a noise in a hall. After hearing the dry sound directly from the source, you will hear a number of sounds reflected from the walls, ceiling, floor, and any other objects with hard surfaces. These are called the early reflections. The time between the dry sound and these early reflections is called the pre-delay time, and it will vary depending on the size of the hall. Eventually, these reflections become less intense and they start to merge together to form a dense reverb that gradually fades away. The time that it takes for the reverb to fade away is known as the reverb time. This is also dependent on the size of the hall.

The tonal quality of these reflections depends on the material used in the walls, ceiling, and other objects in the room. If a room contains many soft materials, for example, they will tend to absorb the high frequencies. So the reverb will appear to contain few high-frequency reflections. This can be simulated using a reverb effect's High Damp parameter.

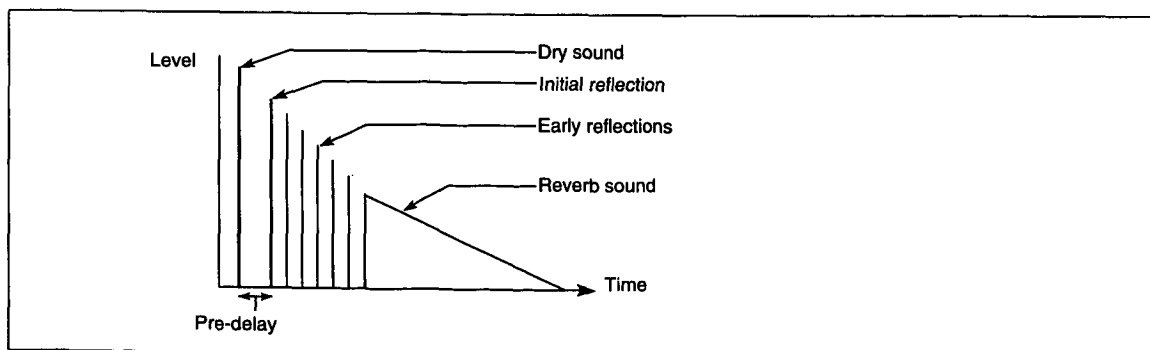

Spatial Effects for the Sound Creation Process

As well as providing spatial simulation, the following effects can also be used as part of the sound creation process itself. These include early reflection, delay, chorus, and flanger.

2) Early reflection

This effect produces just the early reflections of a reverb effect. Using just these early reflections, you can add weight to a sound or create gated reverb type effects. The X2/X3 contains three early reflection effects: 10:EarlyRef1, 11:EarlyRef2, and 12:EarlyRef3. In the EarlyRef3 effect, the volume level of the reflections increases over time, producing a sort of backward effect.

3) Delay

Although both reverb and delay use sound delay techniques, they are in fact totally different effects. Reverb is what you hear in a hall, and delay is what you hear in the mountains. While reverb consists of a gradually fading wash of reflections, delay consists of a series of distinct repeats at regular intervals. The time between the dry sound and the first delay sound is called the delay time. Subsequent repeats are caused by feeding the signal back into the effect. The number of repeats is usually determined by a Feedback parameter. The X2/X3 contains six types of delay: from 13:StereoDly to 18:M. TapDly. Basic delay effects are used to add spatial character to a sound. The X2/X3's more complex delays, such as cross and multi-tap, are best used as part of the sound making process to create new and exciting sounds.

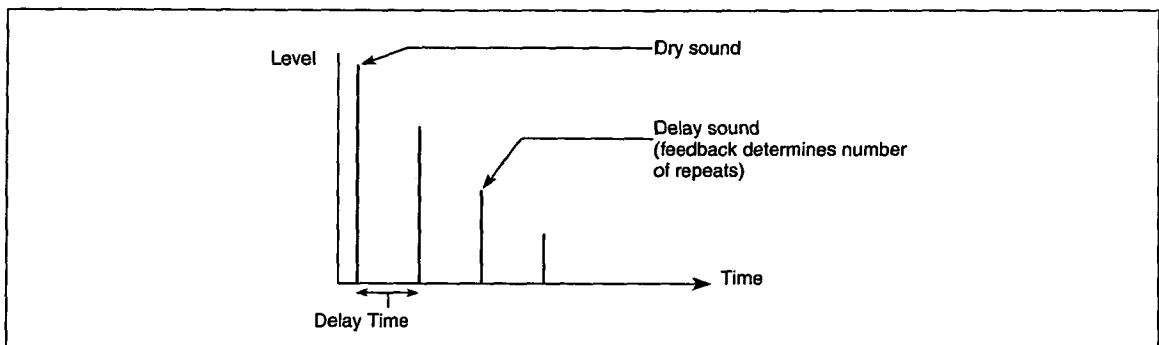

4) Chorus

The chorus effect simulates the ensemble sound of several musicians, and it is ideally suited for use with electric pianos, strings, guitars, and so on.

In an ensemble, pitch variations between instruments create a rich, slightly warbling sound. Essentially, this gives the impression that a number of musicians are playing together. The chorus effect simulates this by delaying the signal and modulating the delay time using a low frequency oscillator (LFO). Modulating the delay time produces a continuously changing pitch. The delayed signal is then mixed with the dry signal to produce the slight warbling sound of a real ensemble. The speed of the LFO, and in turn the pitch variations, is determined by the modulation speed. The amount by which the LFO modulates the delay time, and hence the pitch, is determined by the modulation depth.

The X2/X3 contains six chorus effects: from 19:Chorus1 to 24:Symp. Ens.

5) Flanger

Although similar to chorus, a flanger uses a shorter delay time and feeds some of the output signal back into the effect. This results in an effect that is significantly different to chorus. Technically speaking, a flanger utilizes a comb filter to alter the pitch characteristics of a sound. Flangers work very well on sounds that contain a lot of harmonics.

The X2/X3 contains three flanger effects: from 25:Flanger 1 to 27:XovrFlngr.

Effects that Change a Sound's Tonal Quality

The following effects change a sound's tonal quality.

6) Exciter

The exciter effect (28:Exciter) adds new harmonics to a sound, thus producing a subjective increase of clarity and definition, which helps to make a sound's individual character stand out.

7) Enhancer

The enhancer effect is similar to the exciter, but with a delay for creating a more spatial sound with a wider stereo width.

8) Distortion

Originally developed for use with guitars, the distortion effect simulates the distortion produced when amplifier circuits are overdriven with excessive signal and gain levels. It tends to thicken single sounds, making it very effective for solo instruments. When used with chords it tends to muddy the overall sound. The X2/X3 contains two kinds of distortion effects: 30:Dist and 31:Over Drv.

9) Phaser

As its full name implies—phase shifter—the phaser effect shifts a sound's phase. Without going into details about phase, a phaser utilizes both phase shifting and time delay to produce a more pronounced swirling and swishing sound. While chorus and flanger modulate the delay time, a phaser modulates phase. It is effective with electric piano, guitars, synthesizer sounds, and bass sounds with a reasonable sustain. The X2/X3 contains two phaser effects: 32:Phaser 1 and 33:Phaser 2.

10) Rotary speaker

This effect (34:Rot. Spk) simulates the rotating speaker effect used in organs. In a real rotary speaker cabinet, the horn speaker is actually rotated. This continuous rotation causes a Doppler effect, like the sound you hear when an ambulance drives past with its siren on. At a slow rotation speed the effect is almost like chorus. While at a higher speed it's similar to tremolo. However, the rotary speaker effect does have its own unique character, and it is ideal for use with organ sounds. In fact, the two are synonymous.

11) Tremolo

The tremolo effect produces regular changes in volume level. The Auto Pan effect (35:Auto Pan) creates a stereo type tremolo effect by modulating the left and right channels inversely. This is popular with suitcase style electric pianos. Tremolo effect 36:Tremolo modulates both channels in sync. Tremolo is very effective on long notes and big chords.

12) Parametric equalizer

Effect 37:Para. EQ is a three-band parametric equalizer. The cutoff frequency for the low and high band filters can be set independently. For the mid-band filter, center frequency and bandwidth can be set.

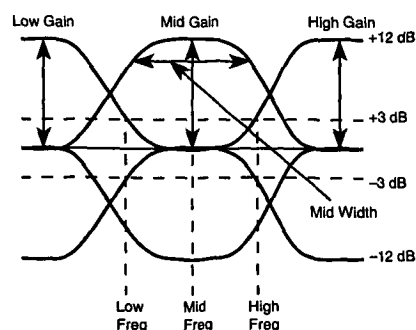

Using the Effects

Connections

There are four buses that feed the two multi-effects processors: A, B, C, and D. Combinations are fed to the effects using their Pan, Send C, and Send D parameters. For Programs, the Pan, Send C, and Send D parameters appear on LCD screens 1B and 1C. For Combinations, the Pan parameters appear on LCD screen 2B, and the Send C and Send D parameters appear on LCD screen 2C. For songs in Sequencer mode, Pan, Send C, and Send D parameters are accessed by pressing function button [2] (TRACK). In Sequencer Edit mode, use LCD screen 1A.

Effects Placements

On the X2, the two digital multi-effects processors can be used in any one of six placements. On the X3, any one of four. Placements affect the way in which the input buses (A, B, C, D) are routed through the processors. To select a placement, select LCD screen 7E. Effect settings and their placements are set independently for Programs, Combinations, and songs. See “7E Effect Placement” on page 59 of the *Reference Guide*.

Chapter 8: Program Edit Tutorial

Although you can make your own Combinations using the preset Programs, you shouldn't limit your creativity by relying on the presets alone. Sound making really starts to get interesting when you create a sound using the various building blocks that go into making a Program. In this tutorial we take a look at the main building blocks that make up a Program and how they work.

As mentioned earlier, some Program parameters can be edited in Program Play mode. However, you need to enter Program Edit mode to access all the parameters. To do this, press the [PROG] button to select Program Play mode, then press the [EDIT] button to select Program Edit mode. For details about setting parameters, see "Setting Parameters" on page 19.

Three Sound Building Blocks

Sounds consist of three main components: pitch, tone, and volume. In a tone generator, each of these components has its own corresponding building block. In the X2/X3, pitch is handled by the OSC (oscillator) block, tone by the VDF (Variable Digital Filter) block, and volume by the VDA (Variable Digital Amplifier) block. The following illustration shows the three blocks.

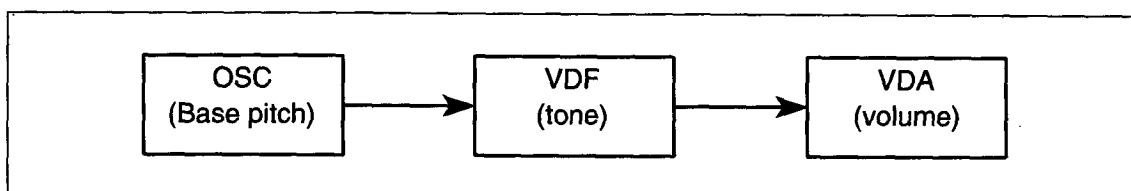

Volume Editing

The volume level of a musical instrument changes over time. The way it changes is what gives a sound its distinctive character. The following illustrations show how the volume levels of piano and strings change over time.

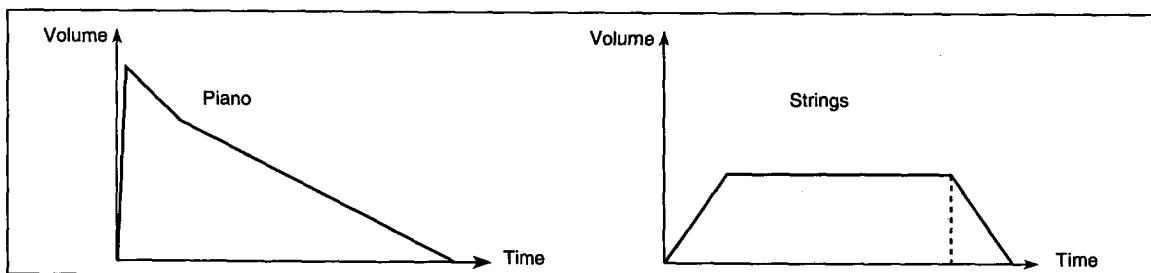

The volume changes shown in the above illustrations are called envelopes. In an X2/X3 Program, an Envelope Generator (EG) is used to create these volume-over-time changes. The VDA (Variable Digital Amplifier) uses the EG parameters to control its volume.

To hear this in action, let's edit a Program. In Program Play mode, select and play Program A01 Piano 16'. This is a typical piano sound. Press the [EDIT] button to enter Program Edit mode, then press function button [4] (or the [↑] cursor button five times) to select LCD screen 4A. The bottom line of the LCD shows the VDA1 EG parameters. Currently, the cursor is located on the AT (Attack Time) parameter, and its value is set to 00. Use the VALUE slider to adjust this value. When it reaches about 60, the piano Program starts to sound more like strings than piano.

The “>” symbol at the right-hand side of the LCD indicates that more parameters are available. Press the [←] and [→] cursor buttons to select these other parameters, and try editing their values. The VDA EG has seven parameters. The following illustration shows how they affect the envelope.

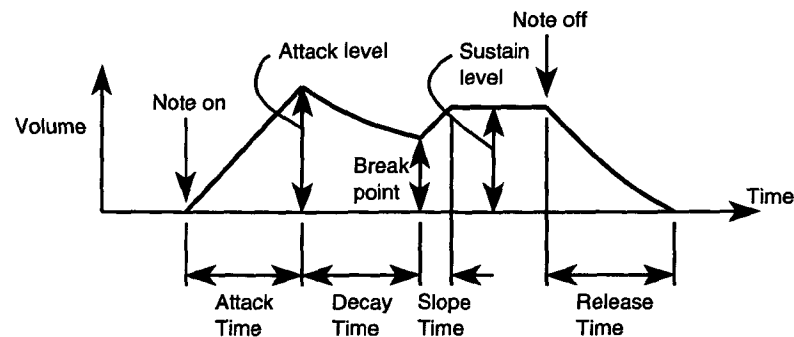

The VDA EG is a very important element for sound creation. Understanding the relationship between each parameter and the EG envelope will allow you to edit with ease.

Tone Editing

The basic tonal quality of an X2/X3 sound is determined by the waveform that you assign to an oscillator. Further tonal editing can be performed using the VDF.

1) OSC Multisounds

Musical instruments typically have only one waveform. The X2, on the other hand, contains 341 different waveforms, while the X3 contains 340. These include acoustic instruments, electric instruments, and unique synthesizer waveforms. On the X2/X3, these waveforms are called Multisounds. X2/X3 Multisounds allow you to simulate real instruments and create original and exciting sounds of exceptional quality.

Let's listen to some Multisounds. Select Program A52 FlugelHorn, then press the [Edit] button to enter Program Edit mode. Press the [↑] cursor button once to select LCD screen 1B. The OSC1 SOUND parameter indicates that the FlugelHorn Program is currently using Multisound 151:FlugelHorn. Use the VALUE slider to select some other Multisounds. The following illustration shows LCD screen 1B, with the OSC1 SOUND parameter, and the locations of the [EDIT] button and the [↑] cursor button.

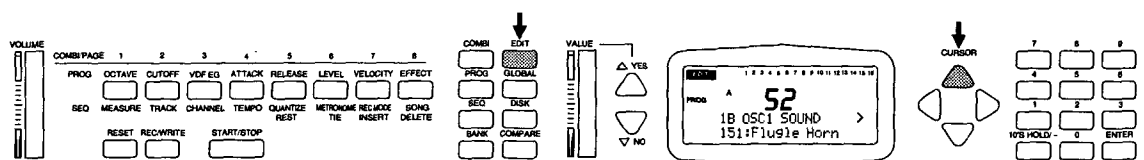

2) Using the VDF

Ultimately, the tone of a sound is determined by the chosen Multisound. However, the VDF (Variable Digital Filter) can be used to filter high frequency components from a Multisound. Let's look at this in a Program. Select Program A93 DWGS EP. This is an electric piano sound. Press the [EDIT] button to enter Program Edit mode, then press function button [3] (or the [↑] cursor button three times) to select LCD screen 3A. Currently, the cursor is located on the Fc (Cutoff Frequency) parameter and its value is set to 16. Adjust the value. As the value is raised, the sound becomes brighter. This is because the high frequency components now pass through the filter. Typically, low filter values make a sound darker, while high values make them brighter.

The following illustration shows the response curve of the filter. It is a Low Pass Filter (LPF), which means that frequencies below the cutoff frequency pass unaffected, while frequencies above, are filtered.

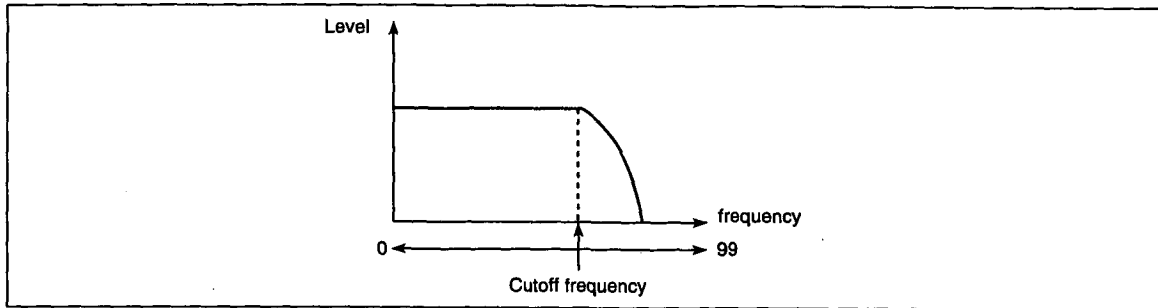

With the cutoff frequency set to 99, no high-frequency components are filtered. The filter allows you to create sounds far removed from the original Multisound.

The “>” symbol at the right-hand side of the LCD indicates that more parameters are available. Pressing the [→] cursor button twice will access the VDF1 EG parameters. The EG allows you to specify how the Cutoff Frequency will change over time. Press the [→] cursor button three times to select the Break Point parameter, and set it to -99. Then press the [→] cursor button once more and edit the other parameters. The sound will now get dark, and then become brighter.

The following illustration shows which parts of the envelope these parameters affect.

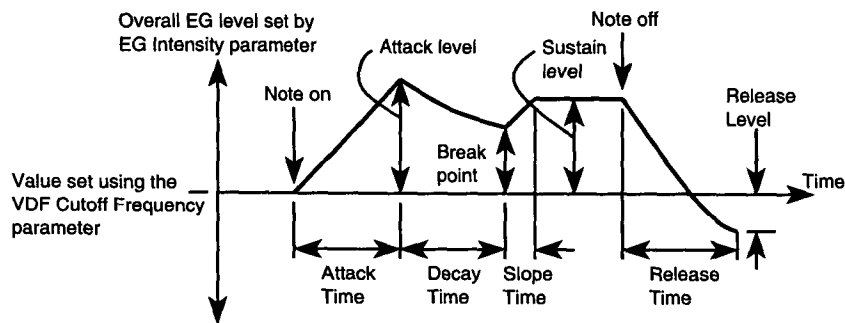

Just like a real musical instrument, the tonal quality of a Multisound changes over time. The VDF EG allows you to shape a Multisound even more, making the VDF EG an important sound building block. Unlike the VDA EG, the VDF EG has a Release Level and Time parameters, and all level parameters can be set to negative values.

A Few Words about Pitch

As well as a VDA EG and a VDF EG, the X2/X3 also has a Pitch EG. Although the pitch of an acoustic instrument will change as different notes are played, it is rare for the pitch of sounding notes to change over time. Therefore, the VDA EG and VDF EG are probably more important when creating sounds. However, the Pitch EG can be used to create unusual and special effect type sounds. It can also be used to create subtle pitch changes during the initial attack time. See “2A Pitch EG” on page 14 of the *Reference Guide*.

What is Double Mode?

Just as you can layer Programs (Timbres) in a Combination, you can layer Multisounds in a Program by assigning different Multisounds to oscillator 1 and oscillator 2. In Program Edit mode, set the OSC Mode (oscillator mode) parameter on LCD screen 1A to DOUBLE, and another set of OSC, VDF, and VDA parameters will appear.

Double mode allows you to combine two different Multisounds in a Program, or use the same Multisound twice, but vary the pitch of each to produce a thick and rich sound. The Programs that we have experimented with so far have been Single mode Programs. However, most of the X2/X3 Programs are in fact Double mode Programs.

Remember that the X2/X3 polyphony is reduced from 32 to 16 notes for Double mode Programs.

Programs with Effects

X2/X3 Programs can be saved with their own individual effects settings. However, when a Program is used in a Combination, its effects settings are ignored, and the effects settings for that Combination are used. Bare this in mind when creating Programs that will eventually be used in Combinations.

Saving Programs

If you select another Program without saving first, your edits will be lost. If you want to save them, you must write the Program to memory. To do this, press the [REC/WRITE] button. An "Are You Sure?" message will appear. Press the [▲/YES] button to write the Program, or the [▼/NO] button to cancel. Note that if you write, you will overwrite the Program that already exists with that number. To write the Program to a different Program number or change its name, you need to enter Program Edit mode. See "8A Program Write" on page 32 of the *Reference Guide*.

Creating Original Sounds

In order to create original sounds, it is important to avoid getting caught up in established concepts. It is also important to form a clear idea of the sound that you want to create. For example, don't be limited by the names of the Multisounds. Don't think, for example, that you must put a bass envelope on a Multisound just because it's called A.Bass. Try using this bass Multisound in a high frequency range, with a typical slow strings type envelope. Truly original sounds are born out of this kind of experimentation.

The same holds true for effects processors. There's no need to believe that overdrive works only for guitars, or that the rotary speaker effect only works with organs. Don't be trapped by common sense; instead, be willing to give anything a try.

While you are experimenting, try to keep in mind the image of the sound you are creating. Even a partial image, such as that of "a soft and spacey sound", will give you at least a few clues; e.g., it should have a slow VDA EG attack, for example, and relatively dull harmonics. With your image as a starting point, you can try VDA EG and VDF EG parameter settings, look for an appropriate Multisound, and try a number of variations. Eventually, you will come up with the original sound you're looking for—probably something better.

Chapter 9: Using the X2/X3 Sequencer

The X2/X3 is a workstation type synthesizer with a built-in sequencer. The X2/X3 sequencer has many powerful and comprehensive functions for use as a stand-alone sequencer. In addition, it has the following advantages over most computer based sequencers: 1) Sequencer data is stored even when the X2/X3 is powered off. As well as preventing data loss, this also means that you can start playback as soon as you power on. You don't have to bother loading floppy disks. 2) You can input an idea for a melody or song outline very quickly. These features allow you to use the X2/X3 in the following applications.

Using the X2/X3 as Your Main Sequencer

The X2/X3 sequencer's powerful and comprehensive functions make it ideal for use as the main sequencer at the heart of a MIDI music production system.

You can perform real-time or step-time recording for tracks and patterns. For more details about the sequencer, see page 75 "Sequencer mode" and page 93 "Sequencer Edit mode" of the *Reference Guide*.

Using Standard MIDI Files

You may need to transfer your song data from a computer sequencer to the X2/X3. You can do this by saving your songs as Standard MIDI Files (SMF). The X2/X3 can then read the SMF song data straight off an MS-DOS format floppy disk.

To read an SMF file, press the [DISK] button to enter Disk mode, then select LCD screen 5A. Insert the floppy disk that contains the SMF song data. The message "Directory OK?" will appear. Press the [▲/YES] button. The following illustration shows the location of the [DISK] button, the [▲/YES] button, and function button [5] that is used to access LCD screen 5A.

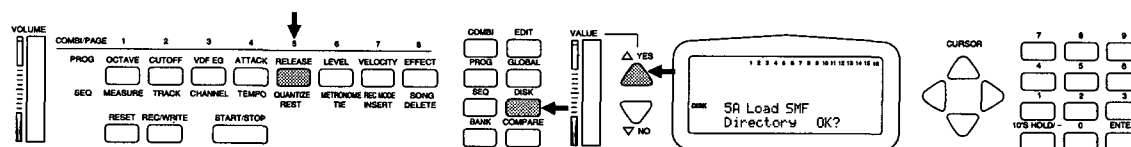

Use the VALUE slider or the [▲/YES] and [▼/NO] buttons to select the SMF file that you want to load, then press the [→] cursor button to select the destination song into which the data should be loaded. Press the [→] cursor button again to move the cursor to "OK?", then press the [▲/YES] button. The following illustration shows LCD screen 5A with the Destination Song parameter.

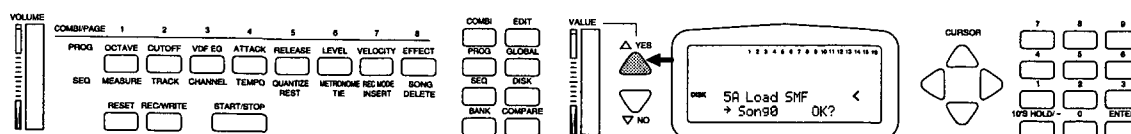

The message "Are You Sure OK?" will appear. Press the [▲/YES] button to load, or the [▼/NO] button to cancel. While loading, the message "Now Loading..." will be shown. When loading is complete, the message "Completed" will appear.

To play the loaded SMF data, press the [SEQ] button to enter Sequencer mode. Then press function button [8], and use the VALUE slider or the [▲/YES] and [▼/NO] buttons to select the song for playback. The following illustration shows the locations of the [SEQ] button and function button [8].

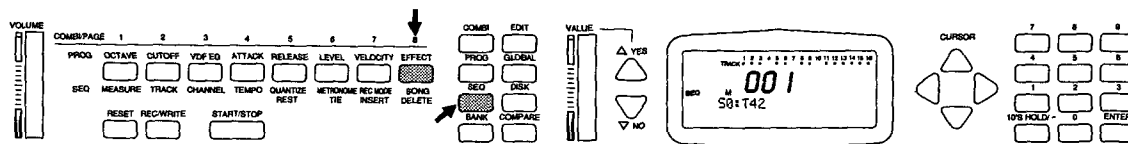

To start playback, press the [START/STOP] button. Press the [START/STOP] button again to stop playback. Pressing it again will restart playback from the point where it was stopped. To start playback from the beginning of a song, press the [RESET] button before starting playback.

Using the X2/X3 Sequencer as a Musical Sketch Pad

Not many software based sequencers allow pattern recording. Even some stand-alone sequencers do not have pattern recording functions. The X2/X3 not only allows pattern recording, but all sequencer data is continuously backed up, so you don't have to bother with floppy disks. These features are extremely useful when it comes to capturing ideas, which can easily be forgotten in the time it takes to load a floppy disk. Patterns allow you to experiment with song development by stringing various patterns together, listening to the result, then deciding on the best arrangement. See "5A Real-Time Pattern Record/Edit" on page 143 of the *Reference Guide*.

Chapter 10: Playing GM Songs

The X2/X3 can playback GM compatible songs in two ways: by receiving the song data via the MIDI IN connection, or by loading the GM (General MIDI) song via the SMF (Standard MIDI File) format from a floppy disk. Here we explain how the X2/X3 can play GM song data received via the MIDI IN connection. The following illustration shows how to connect such a system.

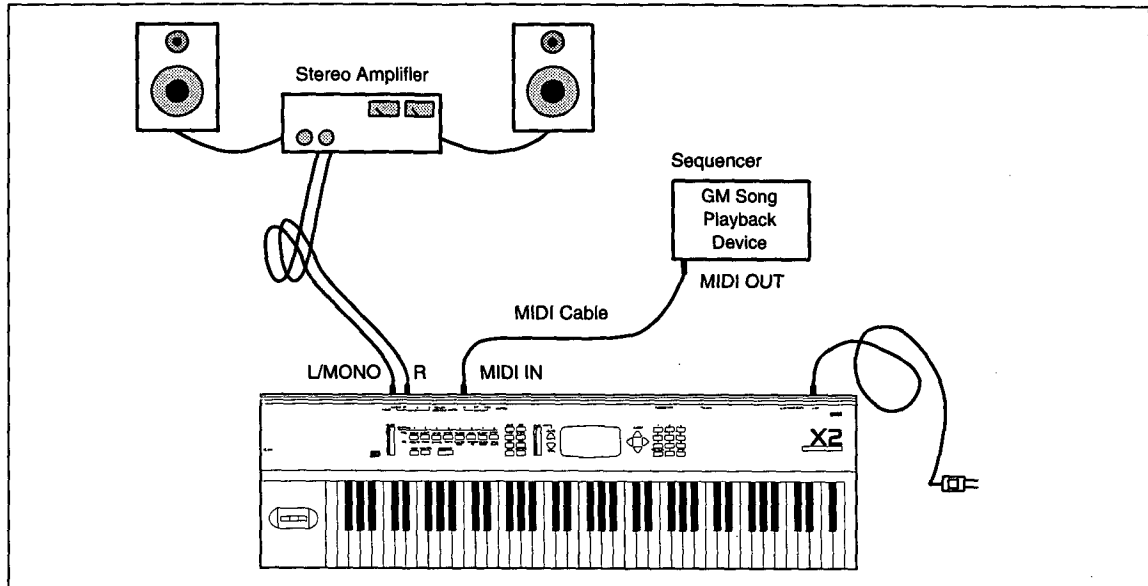

- 1) Connect the MIDI OUT of the device that contains the GM song data to the X2/X3's MIDI IN.

Note: If the GM song data contains a GM System On message, the X2/X3 will automatically select song 9 and conform it to GM when it receives this message. However, if the GM song data does not contain a GM System On message, you must set up the X2/X3 as explained below.

- 2) Press the [SEQ] button to select Sequencer mode.
- 3) Press function button [8] to select the song select LCD screen, then use the VALUE slider or [▲/YES] and [▼/NO] buttons to select a song (an unrecorded song).
- 4) Press the [EDIT] button to enter Sequencer Edit mode.
- 5) Press function button [8], then press the [↑] cursor button five times to select LCD screen 8F.
- 6) Press the [▲/YES] button to conform the song to GM. Press the [▲/YES] button again to confirm the "Are You Sure OK?" message.
- 7) Playback the GM data on the sequencer.

About GM Song Data

Typically, each track of a GM song will contain a MIDI Program Change message. When the X2/X3 receives these Program Change messages, it selects the correct Program for each track. This ensures that a piano track gets a piano Program, a bass track gets a bass Program, and so on. Drums are always on track 10. If you are having trouble playing back some GM song data, check the following Global mode parameter settings.

LCD Screen	Parameter	Value
1B Transpose	Transpose	+00
1C Keyboard After Touch & Velocity Response Curve	Velocity Response	3
	After Touch Response	3
2A Keyboard Scale	Scale Type	Equal Temperament
3B Note Receive Filter	Note Receive Filter	ALL
3C MIDI Filter1	Program Change Filter	ENA, NUM
	After Touch Filter	ENA
3D MIDI Filter2	MIDI Controller Filter	ENA
	System Exclusive Filter	DIS

Chapter 11: X2/X3 Data Compatibility

X2, X3, X3R

The X2/X3 is compatible with X3R data cards, disks, and MIDI Dump data. Operations after data loading may be slightly different depending on the number of Multisounds, different effect placements, damper pedal connection, transpose, velocity curves, and After Touch curves. However, this does not mean that the data is modified when loaded. The following illustration and explanatory text below shows how data can be exchanged between the X2, X3, and X3R.

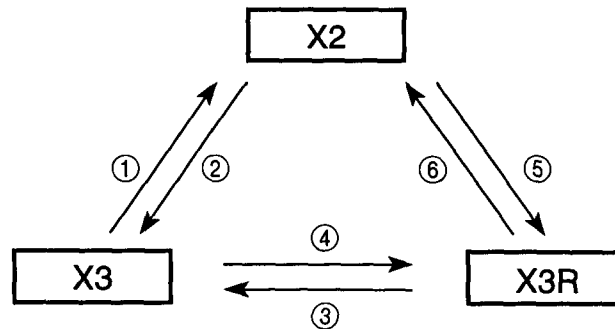

- 1) Compatible.
- 2) Multisound #340 shows “Invalid No”, and no sound is produced. Both Serial Sub and Parallel Sub effect placements are converted to Parallel 3.
- 3) Both Serial Sub and Parallel Sub effect placements are converted to Parallel 3.
- 4) Global parameter Damper Polarity is ignored. Transpose, Velocity Curve and After Touch Curve match those of the X3R.
- 5) Global parameter Damper Polarity is ignored. Multisound #340 shows “Invalid No”, and no sound is produced.
- 6) Compatible.

Compatibility with 03R/W Cards

The X2/X3 can use Korg 03R/W cards. Programs, Combinations, and drum settings can be loaded in Global mode. However, you cannot load the Global settings and demo song data. RAM card data from a 03R/W can also be used, however, the following parameters will be changed:

- If the same Multisound is not available, a similar one will be selected.
- Oscillator level is set to half.
- Pan settings (A–D) are conformed to pan (A and B) and Send C and Send D.
- Drum kit exclusive assign groups 7 to 9 are changed to group 6.

Note that you cannot use X2/X3 PROG/SEQ cards in a 03R/W.

Compatibility with i2/i3 Floppy Disks

User Programs made on a Korg i2/i3 (the 64 voices in bank D and drum programs 7 and 8) can be loaded into the X2/X3 using the Load All Data function in Disk mode. The 66 Programs from the i2/i3 will be loaded into bank A (Programs 00–65). Drum kits 1 and 2 are loaded, however, global settings are not.

Song data is compatible. However, if you try to load the Programs from the i2/i3 into the X2/X3, or load the X2 Programs into the i2/i3, the Program numbers will be converted as follows.

i2/i3		X2/X3
Bank — A11–88	↔	Bank — GM1–64
Bank — B11–88	↔	Bank — GM65–128
Bank — C11–88	↔	Bank — B00–63
Bank — D11–88	↔	Bank — A00–63
DRUM PROG 7	↔	Bank — A64
DRUM PROG 8	↔	Bank — A65

Chapter 12: X2/X3 Sound Lists

Combinations

Bank A

#	Name	D.Mod.Src	Type	#	Name	D.Mod.Src	Type
00	Star* Burst	VS/AT	Split/VSw	05	Calcutta	---	Split/VSw
10	First* Snow	VDA	Split	15	Javanese	JS/VS	Layer
20	Rezolution	JS/VS/VDA	Layer	25	Tethnical	---	Split/VSw
30	StormOf'93	VDA	Layer	35	Bass&Vibes	JS/VS	Split/VSw
40	Bell Come!	JS/VS	Layer	45	Instanbul	AT	Split/VSw
50	Beach Walk	VDA	Layer	55	SugarBells	VS/AT	Split/VSw
60	Autumn	VDA	Layer	65	Ethno Geo	---	Split
70	Child Song	---	Split	75	Bolshoi	JS/VS	Layer
80	SunOfTron	JS/VS/AT	Split/VSw	85	The Sphinx	JS/VS	Split/VSw
90	FreeTime	VS/AT	Split	95	ChinaBell	JS/VS	Split/VSw
01	LayerPiano	VDA	Layer	06	FunkySpice	VS/AT	Layer
11	Bass&Piano	VS	Split/VSw	16	L'ilBit O'	AT	Layer
21	The Gospel	JS/VS	Layer/VSw	26	Full Pipe	---	Layer
31	Stak'oMidi	VDA	Layer	36	Super Perc	VS	Layer
41	EP&String	---	Layer	46	Busy Split	---	Split/VSw
51	DynoPiano	VS	Split	56	Blues Harp	JS/VS	Layer
61	ElecPno&Bs	VS	Split/VSw	66	Ruff&Ready	JS/VS	Layer
71	Pontette	AT/VDA	Layer	76	Wasp Sting	VS/AT	Layer
81	SamAntic	JS/VS	Split/VSw	86	Deep Organ	---	Layer
91	PianoSings	VDA	Split	96	Sky Cat	JS/VS	Layer
02	Synth Fat	JS/VS	Layer	07	Layer Str	JS/VS	Layer
12	Full Brass	VDA	Split/VSw	17	Philarmoney	JS/VS	Split/VSw
22	New Rave	JS/VS/AT	Split/VSw	27	Overture	JS/VS	Split/VSw
32	SmokyHorn	JS/VS	Split	37	Pizz & Bow	JS/VS	Layer
42	Latin Band	JS/VS	Split/VSw	47	Orchestral	JS/VS	Split
52	Centrefold	---	Layer	57	Grandioso	JS/VS/VDA	Split
62	MasterFunk	---	Split/VSw	67	Madrigal	JS/VS	Layer
72	GoToSweep	JS/VS	Layer	77	AnaStrings	VDA	Layer
82	SweetMutes	VS	Layer	87	StringsAtk	JS/VS	Layer
92	BiggerIdea	---	Split	97	HarpString	JS/VS	Layer
03	Satellite	---	Layer	08	Sax Heaven	VS/VDA	Split
13	Sing To Me	VDA	Split	18	Half Moons	VS/AT	Layer
23	FlutterPad	---	Layer	28	Lead & Pad	JS/VS	Split
33	VeloVoxBel	VS	Layer/VSw	38	Aquarium	VDA	Split
43	HumanBeam	JS/VS	Split/VSw	48	CymbalLife	---	Layer
53	InTheLight	JS/VS	Split	58	Osaka Jazz	JS/VS/VDA	Split
63	VeloVoices	JS/VS	Layer/VSw	68	ChiffSplit	---	Split
73	SilkRoad33	VS/AT	Split	78	ChrisTall	JS/VS	Split/VSw
83	Nebulae	JS/VS	Layer	88	Lassie&Tim	---	Split
93	Safari	---	Split	98	Night Taps	JS/VS	Layer
04	Mr. Tone	---	Split	09	Celebrate!	JS/VS/VDA	Split/VSw
14	Mr.Chorus	JS/VS	Split/VSw	19	HereltComz	JS/VS	Split/VSw
24	ShoeString	---	Split	29	Dulcimer	VS/AT	Layer
34	Slap & Pop	---	Layer/VSw	39	HouseParty	JS/VS	Split/VSw
44	12 Stereo	---	Split/VSw	49	Space Port	VS/AT	Split
54	Velo Chord	JS/VS	Split/VSw	59	MasterFisa	JS/VS	Layer
64	Split Bass	VS	Split/VSw	69	Dagobar	JS/VS	Layer
74	Nashville	---	Split	79	Rave Hits	JS/VDA	Layer
84	Dole Bee	VDA	Split/VSw	89	DeathStars	JS/VS	Split/VSw
94	Guitar&Pad	JS/VS	Split	99	Slammin'	JS/VS	Split/VSw

Bank B

#	Name	D.Mod.Src	Type	#	Name	D.Mod.Src	Type
00	Sea Horses	VS/AT	Split/VSw	05	IndianOrch	JS/VS	Split/VSw
10	Backyard	JS	Layer	15	Fairy Bell	AT	Layer
20	Right&Left	VS/VDA	Layer	25	Ethnetic	VS	Split
30	Rain Chime	JS/VS	Split	35	VibeRation	JS/VS	Layer
40	Blade Runs	JS/VS	Split/VSw	45	Sting&Wind	VDA	Split
50	PowderSnow	VS/AT	Layer	55	Baseball	---	Layer
60	Pollenesk	VDA	Layer	65	Milagro	VDA	Layer/VSw
70	TheyAppear	JS/VS	Split	75	12ToneBelz	JS/VS/AT	Split
80	Vectoring	JS/VS	Layer	85	ShakAttack	JS/VS	Split/VSw
90	Encounters	VS/AT	Layer	95	Randomizer	VS	Layer/VSw
01	Power Comp	VDA	Layer	06	Pop Clav	VS	Layer
11	CountOnMe	---	Split	16	Rotary Man	VS/AT	Layer
21	Two In One	JS/VS	Split/VSw	26	WeddingDay	---	Split
31	Remedies	---	Split/VSw	36	SplitOrgan	---	Split
41	Piano Pad	VDA	Layer	46	ToBeBass	JS/VS	Split
51	Tiny&Tiny	VS	Split/VSw	56	Organ Pad	---	Split
61	Bass&EP	VS	Split/VSw	66	Fusionist	JS/VS	Layer
71	Emmabama	VS	Layer/VSw	76	Have Fun	JS/VS	Split
81	Hard&Sweet	VS/AT	Split	86	Mixture	---	Split
91	Layer Cake	---	Layer	96	Fuzz EP	---	Layer
02	Midi Winds	---	Layer	07	Double Bow	VDA	Layer
12	Trpt.Brass	---	Layer	17	Leti Theme	JS/VS	Split/VSw
22	ODriveLead	JS/VS/AT	Layer	27	Concerto	VS	Split
32	Big Band	VDA	Split/VSw	37	Pizz A Pie	JS/VS	Layer
42	MillerTime	AT	Split/VSw	47	Delicato	JS/VS	Layer
52	Emmalog	---	Layer	57	BigStrings	VS	Split
62	BadScream	VS	Layer/VSw	67	WoodSector	VDA	Split/VSw
72	TheSweeper	JS/VS	Split	77	Bows&Brass	JS/VS	Split
82	Trombhorns	---	Split	87	The Finale	---	Split/VSw
92	Puffalog	VDA	Layer	97	HornMelody	JS/VS	Split
03	ProxiMidi	---	Layer	08	Alto Dream	VS	Split
13	Acappella	JS/VS	Layer	18	Canyon	JS/VS/AT	Layer
23	TheRedSun	JS/VS	Layer	28	LegatoReed	JS/VS	Split
33	VoxGamelan	---	Layer	38	TechnoPres	VS/AT	Layer
43	Wood Vox	---	Layer	48	Sophism	---	Layer
53	Dreamy P	AT/VDA	Layer	58	Cool Duet	---	Split
63	AlienSings	JS/VS	Layer	68	TypeALine	JS/VS	Split
73	Dreaming	AT/VDA	Layer	78	Echo Suite	---	Split
83	Synmonics	JS/VS/VDA	Layer/VSw	88	Fif- Dsplit	---	Split
93	Pad+Alpha	VDA	Layer	98	Acid Tools	JS/VS/VDA	Layer
04	Oh- La- La !	JS/VS	Split	09	VillageJam	JS/VS	Split/VSw
14	AndyPlayIt	JS/VS	Layer/VSw	19	StealDrums	VS	Split
24	Guitairs	JS/VS	Split/VSw	29	Bavaria	AT	Split
34	DynamoBass	VS	Layer/VSw	39	Witch Hunt	JS/VS	Split/VSw
44	Folk Picks	---	Split/VSw	49	Ethno Vox	JS/VS	Split
54	RockShow!	JS/VS	Split	59	Mazurca	JS/VS	Split
64	Bass Solo	JS/VS	Layer/VSw	69	Bug Forest	JS/VS	Split/VSw
74	Fat Pluck	---	Layer	79	Percolator	JS/VS	Split
84	TwoWorlds!	VS	Layer/VSw	89	AfricaMood	VS	Split
94	BreakADish	---	Split/VSw	99	TimeTunnel	VS/AT	Layer

JS=Joystick, VS=Value Slider, AT=After Touch, VDA=VDA EG, VSw=Velocity Switch

Programs

Bank A

#	Name	D.Mod. Src	#	Name	D.Mod. Src
A00 *	Sunrise	---	A05 *	Vibra Bell	JS/VS
A10 *	MachineAge	---	A15 *	Tabla Talk	JS/VS
A20 *	GlideSweep	VS/AT	A25	Gamelan	JS/VS
A30 *	Space Wing	---	A35 *	Dustette	VS/AT
A40	Neutron	---	A45	SplitBell	JS/VS
A50 *	DreamWorld	JS/VS	A55 *	Africana	VS
A60	Spectrum	JS/VS	A65	Isabelle	VS/VDA
A70 *	InTheTrees	---	A75	Log Drums	JS
A80	Halifax NS	VDA	A85	EtherBells	JS
A90	SteamCloud	VS/AT	A95	WaveCycles	JS/VS
A01	★1	---	A06 *	XFade Bass	JS/VS
A11 *	Hot Keys	VS/AT	A16 *	FingerBass	JS/VS
A21 *	Last Tango	---	A26 *	Zap Bass	JS/VS
A31 *	Gospel Org	VS/AT	A36	PickedBass	JS/VS
A41 *	PianoHaven	JS/VS	A46 *	Slap It	JS/VS
A51 *	HarpFunk	---	A56 *	TechnoBass	VS/AT
A61 *	Full Pipes	JS/VS/AT	A66 *	Fat Fretty	---
A71 *	SantaClav	---	A76 *	HouseBass1	---
A81 *	Drawbars	VS/AT	A86	Bass/Harm	JS/VS
A91 *	Bouzouki	---	A96 *	Rap Bass	JS/VS
A02 *	AltoBreath	---	A07 *	TheStrings	JS/VS
A12 *	Brass Band	VS/VDA	A17 *	LiteVoices	JS/VS
A22 *	MagicFlute	---	A27 *	DigitalAir	JS/VS
A32 *	Trumpets	---	A37 *	ChamberEns	JS/VS/AT
A42 *	Shaku Bend	VS	A47 *	AnalogPad	JS/VS
A52	FlugelHorn	---	A57 *	Airways	---
A62 *	Woodwinds	JS/VS	A67 *	Poppin'Pad	---
A72 *	Sfz< Brass	JS/VS	A77 *	Ambi.Voice	JS
A82	Fanfare	JS/VS	A87	Air Vox	JS
A92	BriteBrass	---	A97 *	OoooooPad	---
A03 *	TinyDancer	---	A08 *	PowerSynth	JS/VS
A13 *	Maxi Tine	JS/VS	A18 *	Color Pad	JS/VS
A23 *	Operators	JS/VS	A28 *	Analogist	---
A33 *	Fresh Air	VDA	A38 *	Wire Pad	VDA
A43 *	BowenWave	JS/VS	A48 *	Residue	JS/VS
A53 *	Elec. Tap	---	A58 *	Busy Boy	JS/VS
A63 *	Whirly	JS/VS	A68	Soft Horns	VS
A73	Tine Pad	JS/VS	A78 *	MonoLead	VS/AT
A83 *	Hard Tines	VDA	A88 *	Drum Hit	VS
A93	DWGS EP	VS/VDA	A98	Bright Pad	VDA
A04 *	Spruce Gtr	JS/VS	A09@	Total Kit	JS
A14 *	Power Rock	VS/AT	A19 *	Festivall	JS/VS/VDA
A24 *	E.Guitars	JS/VS	A29 *	MandoTrem	---
A34 *	Rock Mutes	JS/VS	A39 *	Industrial	---
A44 *	Clean Funk	JS/VS	A49	Orch Perc	JS/VS
A54	Harmonics	JS	A59 *	Heartbeat	---
A64 *	LeadGuitar	JS/VS	A69@	ProduceKit	JS/VS
A74	PedalSteel	JS	A79 *	Hackbrett	---
A84 *	Dr.Guitar	JS/VS	A89	50's SciFi	JS/VS
A94 *	JoyStickUp	JS	A99 *	HarpPluck	JS/VS

Bank B

#	Name	D.Mod. Src	#	Name	D.Mod. Src
B00 *	ElastikPad	VDA	B05 *	JewelryBox	---
B10 *	Space Pets	JS/VS	B15 *	ShamiMalet	JS/VS
B20 *	BellShower	JS/VS	B25 *	ClockTower	VS/AT
B30	PrarieDawn	---	B35	MagicBell	JS/VS/AT
B40	CicadaBugs	VS/AT	B45 *	Borealis	JS
B50 *	TibetBells	VS/AT	B55 *	HardBamboo	JS/VS
B60	UnderWater	JS	B65 *	VS Bells	JS
B70 *	Wind Storm	JS/VS	B75 *	AfricanJam	---
B80	FlyingToys	JS	B85 *	SolarBells	JS
B90 *	Last Dream	---	B95	Ice Bell	VS/VDA
B01 *	★2	---	B06 *	WoodenYou?	VS/AT
B11 *	VS Organ	VS/AT	B16 *	Bass Solo	JS/VS
B21 *	Fisa 8'	---	B26 *	SweepBass	JS/VS
B31	Rotary Org	JS/VS/AT	B36 *	Bass/Mute	JS
B41 *	Piano&Str	---	B46 *	Fat Slap	---
B51 *	DoubleStop	---	B56	Tech Bass	JS/VS
B61 *	Organ 1	JS/VS/AT	B66 *	Dr.Octave	VS/AT
B71 *	Vectorcord	JS/VS	B76	HouseBass2	---
B81 *	Tone Wheel	JS/VS/AT	B86 *	Funk Bass	VDA
B91 *	OrganTouch	JS/VS/AT	B96 *	Thumb Bass	---
B02 *	PerkySaxes	AT	B07 *	Symphonic	---
B12 *	BrassStereo	---	B17 *	Ice Flakes	VS/VDA
B22 *	TamboFlute	JS/VS	B27 *	Pan Mallet	---
B32 *	Horn Ens	---	B37 *	ArcoAttack	JS/VS/VDA
B42 *	Traverso	---	B47 *	Choir L+R	JS/VS
B52	Warm Tromb	---	B57	Composure	VDA
B62 *	SweetReeds	AT	B67 *	Pitzpan	VDA
B72 *	War Pipes	---	B77	Bottle Pad	VDA
B82	BasoonOboe	AT	B87	Heavenly	JS/VS
B92 *	Mute Ens.	JS/AT	B97 *	Shaku Pad	JS/VS
B03 *	XFade EP	---	B08 *	Lead Stab	JS/VS
B13 *	Methane EP	---	B18 *	Chester	---
B23 *	BuzzComper	VS	B28 *	SteamBrass	JS/VS
B33	Super Tine	JS/VS	B38 *	High Wire	VS/AT
B43 *	SpectrumEP	---	B48	CompThing!	VDA
B53	WaveTap	---	B58 *	BrassSynth	---
B63 *	Mallet EP	---	B68 *	Leeeed	---
B73 *	DigiPiano	VDA	B78 *	SynBrass 4	AT
B83	Emmalisha	JS/VS	B88	Soft Pad	JS/VS
B93 *	Siesta EP	---	B98 *	VeloSweep	---
B04 *	Nylon Gtr	---	B09@	Rave Kit	JS/VS
B14 *	DbiDists	JS	B19 *	RhythmJunk	---
B24 *	Strummers	---	B29	CymbalHit	---
B34 *	ChunkaPick	JS/VS	B39 *	Stab Pad	---
B44	Mr. Clean	JS/VDA	B49	TunedDrums	JS/VS
B54 *	HollowBody	JS	B59 *	EchoTabla	VS/AT
B64 *	ElectricAc	JS	B69@	VeloGated	VS
B74 *	12StringGt	JS/VS	B79 *	SitarSitar	---
B84 *	Organ 2	VS/AT	B89 *	Mysterian	JS/VS
B94	FunkGuitar	JS/VS	B99 *	InTheUood	VDA

★1= X2...X2 Piano X3...Piano 16', ★2= X2...Piano 8' X3...ExpressoPF

JS=Joystick, VS=Value Slider, AT=After Touch, VDA=VDA EG, *="Double Mode"Program, @="Drum Mode"Program

Bank GM

#	Name	D.Mod.Src	#	Name	D.Mod.Src	#	Name	D.Mod.Src
G01	Piano	VDA	G50	SlowString	VDA	G99 *	Crystal	---
G02	BritePiano	VDA	G51 *	Analog Pad	AT/VDA	100 *	Atmosphere	---
G03 *	HammerPno	---	G52	String Pad	JS/VS	101 *	Brightness	VDA
G04 *	HonkeyTonk	VDA	G53	Choir	VDA	102 *	Goblin	VDA
G05	New Tines	VDA	G54	Doo Voice	---	103	Echo Drop	---
G06	Digi Piano	JS/VS	G55	Voices	VDA	104 *	Star Theme	---
G07	Harpicord	VDA	G56	Orch Hit	---	105 *	Sitar	VDA
G08	Clav	VS/AT/VDA	G57	Trumpet	---	106	Banjo	VDA
G09	Celesta	JS/VDA	G58	Trombone	VDA	107	Shamisen	VDA
G10	Glocken	JS/VS	G59	Tuba	AT/VDA	108	Koto	VDA
G11	Music Box	---	G60	Muted Trpt	VDA	109	Kalimba	VDA
G12	Vibes	VS	G61 *	FrenchHorn	VDA	110 *	Scotland	VDA
G13	Marimba	VDA	G62	Brass	VDA	111 *	Fiddle	AT/VDA
G14	Xylophon	JS	G63 *	SynBrass 1	VDA	112	Shanai	---
G15	Tubular	VDA	G64 *	SynBrass 2	AT	113	Metal Bell	VDA
G16	Santur	---	G65	SopranoSax	VDA	114	Agogo	---
G17	Full Organ	VS/AT/VDA	G66	Alto Sax	VDA	115	SteelDrums	---
G18 *	Perc Organ	VDA	G67	Tenor Sax	VDA	116	Woodblock	---
G19	BX-3 Organ	VDA	G68	Bari Sax	VDA	117 *	Taiko	---
G20	ChurchPipe	JS	G69	Sweet Oboe	AT	118	Tom	---
G21	Positive	AT	G70	EnglishHrn	VDA	119	Synth Tom	VDA
G22	Musette	VDA	G71	BasoonOboe	AT	120	Rev Cymbal	JS
G23	Harmonica	VDA	G72	Clarinot	VDA	121	Fret Noise	VDA
G24	Tango	---	G73	Piccolo	VDA	122	NoiseChiff	AT
G25	ClassicGtr	JS	G74	Flute	VDA	123 *	Seashore	JS
G26	A.Guitar	VDA	G75	Recorder	AT/VDA	124 *	Birds	---
G27	JazzGuitar	VDA	G76	Pan Flute	VDA	125 *	Telephone	---
G28	Clean Gtr	JS/VS	G77	Bottle	VDA	126 *	Helicopter	---
G29	MuteGuitar	JS/VS	G78	Shakuhachi	VDA	127 *	Stadium!!	JS
G30	Over Drive	JS/VS	G79	Whistle	VDA	128	GunShot	---
G31	DistGuitar	JS	G80	Ocarina	VDA	129 @	GM Kit	---
G32 *	RockMonics	JS/VS	G81 *	SquareWave	VDA	130 @	Power Kit	---
G33	Jazz Bass	JS/VS	G82 *	Saw Wave	VDA	131 @	Analog Kit	---
G34	Deep Bass	JS/VS	G83 *	SynCaliope	AT/VDA	132 @	Jazz Kit	---
G35	Pick Bass	JS/VS	G84 *	Syn Chiff	---	133 @	Brush kit	---
G36	Fretless	JS/VS	G85 *	Charang	VDA	134 @	Perc Kit	---
G37	SlapBass 1	---	G86 *	AirChorus	---	135 @	Dance Kit	---
G38	SlapBass 2	AT	G87 *	Rezzo4ths	VDA	136 @	Orch Kit	---
G39 *	SynthBass1	---	G88 *	Bass&Lead	---			
G40	SynthBass2	VDA	G89 *	Fantasia	---			
G41	Violin	AT/VDA	G90	Warm Pad	---			
G42	Viola	VDA	G91 *	Poly Pad	---			
G43	Cello	AT/VDA	G92	Ghost Pad	---			
G44	ContraBass	VDA	G93 *	BowedGlass	---			
G45	TremoloStr	VDA	G94 *	Metal Pad	VDA			
G46	Pizzicato	JS/VDA	G95 *	Halo Pad	---			
G47	Harp	VDA	G96	Sweep	VDA			
G48	Timpani	---	G97 *	Ice Rain	---			
G49	Marcato	VDA	G98 *	SoundTrack	---			

JS=Joystick, VS=Value Slider, AT=After Touch, VDA=VDA EG, *="Double Mode"Program, @="Drum Mode"Program

Drum Kits

Drum Kit A1
Total Kit

#	Inst	Key	Excl
#00	046:Orch Crash	B1	---
#01	000:Fat Kick	C2	---
#02	005:Real Kick	C#2	---
#03	002:Ambi.Kick	D2	---
#04	012:Syn Kick 3	D#2	---
#05	007:Gated Kick	E2	---
#06	018:PicloSnare	F2	---
#07	019:Soft Snare	F#2	---
#08	027:GatedSnare	G2	---
#09	029:Syn Snare1	G#2	---
#10	014:Snare 1	A2	---
#11	036:Side Stick	A#2	---
#12	028:Rock Snare	B2	---
#13	059:Tom Lo	C3	---
#14	048:ProcessTom	C#3	---
#15	059:Tom Lo	D3	---
#16	080:ProcessTom	D#3	---
#17	058:Tom Hi	E3	---
#18	048:Tite HH	F3	EX1
#19	051:CloseSynHH	F#3	EX3
#20	048:Tite HH	G3	EX1
#21	052:Open SynHH	G#3	EX3
#22	049:Open HH	A3	EX1
#23	085:Tambourine	A#3	---
#24	050:Pedal HH	B3	EX1
#25	040:Crash Cym	C4	---
#26	040:Crash Cym	C#4	---
#27	054:Ride Edge	D4	---
#28	055:Ride Cup	D#4	---
#29	082:SynMaracas	E4	---
#30	081: Cabasa	F4	---
#31	094:Hand Claps	F#4	---
#32	066:Lo Bongo	G4	---
#33	068:Slap Bongo	G#4	---
#34	067:Hi Bongo	A4	---
#35	086:Cowbell	A#4	---
#36	071:Open Conga	B4	---
#37	071:Open Conga	C5	---
#38	090:Lo Timbal	C#5	---
#39	083:MuteTriang	D5	EX4
#40	089:Hi Timbal	D#5	---
#41	084:OpenTriang	E5	EX4
#42	098:Scratch Hi	F5	EX2
#43	099:Scratch Lo	F#5	EX2
#44	100:ScratchDbI	G5	EX2
#45	023:Rev Snare	G#5	EX5
#46	022:Ambi.Snare	A5	EX5
#47	024:RollSnare1	A#5	EX6
#48	025:RollSnare2	B5	EX6
#49	135:Pole	C6	---
#50	030:Syn Snare2	C#6	---
#51	095:Syn Claps	D6	---
#52	070:Syn Claves	D#6	---
#53	062:SynTom1 Lo	E6	---
#54	062:SynTom1 Lo	F6	---
#55	037:Syn Rim	F#6	---
#56	063:Syn Tom 2	G6	---
#57	063:Syn Tom 2	A6	---
#58	063:Syn Tom 2	B6	---
#59	147: Bell Tree	C7	---

Drum Kit A2
Producer Kit

#	Inst	Key	Excl
#00	004:Punch Kick	C2	---
#01	003:Crisp Kick	C#2	---
#02	000:Fat Kick	D2	---
#03	005:Real Kick	D#2	---
#04	001:Rock Kick	E2	---
#05	002:Ambi.Kick	F2	---
#06	007:Gated Kick	F#2	---
#07	009:Metal Kick	G2	---
#08	008:ProcesKick	G#2	---
#09	006:Dance Kick	A2	---
#10	012:Syn Kick 3	A#2	---
#11	010:Syn Kick 1	B2	---
#12	011:Syn Kick 2	C3	---
#13	013:Orch B.Drm	C#3	---
#14	014:Snare 1	D3	---
#15	019:Soft Snare	D#3	---
#16	015:Snare 2	E3	---
#17	018:PicloSnare	F3	---
#18	017:Snare 4	F#3	---
#19	016:Snare 3	G3	---
#20	020:LightSnare	G#3	---
#21	027:GatedSnare	A3	---
#22	021:TightSnare	A#3	---
#23	028:PowerSnare	B3	---
#24	022:Ambi.Snare	C4	---
#25	023:Rev Snare	C#4	---
#26	026:Rock Snare	D4	---
#27	024:RollSnare1	D#4	EX4
#28	025:RollSnare2	E4	EX4
#29	036:Side Stick	F4	---
#30	029:Syn Snare1	F#4	---
#31	030:Syn Snare2	G4	---
#32	031:Gun Shot	G#4	---
#33	038:VocalSnr 1	A4	---
#34	033:BrushSwish	A#4	---
#35	034:BrushSwirl	B4	EX1
#36	035:Brush Tap	C5	EX1
#37	032:Brush Slap	C#5	EX1
#38	048:Tite HH	D5	EX2
#39	049:Open HH	D#5	EX2
#40	050:Pedal HH	E5	EX2
#41	051:CloseSynHH	F5	EX3
#42	052:Open SynHH	F#5	EX3
#43	040:Crash Cym	G5	---
#44	044:Splash Cym	G#5	---
#45	042:China Cym	A5	---
#46	054:Ride Edge	A#5	---
#47	055:Ride Cup	B5	---
#48	056:Ride Cym 1	C6	---
#49	057:Ride Cym 2	C#6	---
#50	059:Tom Lo	D6	---
#51	059:Tom Lo	D#6	---
#52	058:Tom Hi	E6	---
#53	060:ProcessTom	F6	---
#54	060:ProcessTom	F#6	---
#55	062:SynTom1 Lo	G6	---
#56	061:SynTom1 Hi	G#6	---
#57	063:Syn Tom 2	A#6	---
#58	064:Brush Tom	B6	---
#59	064:Brush Tom	C7	---

Drum Kit B1
Percussion Kit

#	Inst	Key	Excl
#00	005:Real Kick	C2	---
#01	036:Side Stick	C#2	---
#02	014:Snare 1	D2	---
#03	094:Hand Claps	D#2	---
#04	018:Soft Snare	E2	---
#05	059:Tom Lo	F2	---
#06	048:Tite HH	F#2	EX4
#07	048:Tite HH	G2	EX4
#08	049:Open HH	G#2	EX4
#09	059:Tom Lo	A2	---
#10	049:Open HH	A#2	EX4
#11	050:Pedal HH	B2	EX4
#12	059:Tom Lo	C3	---
#13	040:Crash Cym	C#3	---
#14	040:Crash Cym	D3	---
#15	054:Ride Edge	D#3	---
#16	055:Ride Cup	E3	---
#17	071:Open Conga	F3	---
#18	072:Slap Conga	F#3	---
#19	071:Open Conga	G3	---
#20	091:WoodBlock1	G#3	---
#21	086:Cowbell	A3	---
#22	069:Claves	A#3	---
#23	090:Lo Timbal	B3	---
#24	089:Hi Timbal	C4	---
#25	088:R-Timbal	C#4	---
#26	066:Lo Bongo	D4	---
#27	085:Tambourine	D#4	---
#28	067:Hi Bongo	E4	EX3
#29	068:Slap Bongo	F4	EX3
#30	081: Cabasa	F#4	---
#31	082:SynMaracas	G4	EX5
#32	081: Cabasa	G#4	---
#33	081: Cabasa	A4	EX5
#34	080:Maracas	A#4	EX1
#35	080:Maracas	B4	EX1
#36	083:MuteTriang	C5	EX6
#37	108:FingerSnap	C#5	---
#38	084:OpenTriang	D5	EX6
#39	107:Castanet	D#5	---
#40	093:WoodBlock3	E5	---
#41	092:WoodBlock2	F5	---
#42	065:Agogo	F#5	---
#43	091:WoodBlock1	G5	---
#44	065:Agogo	G#5	---
#45	069:Claves	A5	---
#46	065:Agogo	A#5	---
#47	070:Syn Claves	B5	---
#48	071:Open Conga	C6	---
#49	086:Cowbell	C#6	---
#50	071:Open Conga	D6	EX1
#51	093:WoodBlock3	D#6	---
#52	074:Mute Conga	E6	EX1
#53	071:Open Conga	F6	EX2
#54	150:Whistle S	F#6	EX2
#55	072:Slap Conga	G6	EX2
#56	151:Whistle L	G#6	EX2
#57	073:Palm Conga	A6	EX2
#58	101:Thing	B6	---
#59	147: Bell Tree	G7	---

Drum Kit B2
Rave Kit

#	Inst	Key	Excl
#00	010:Syn Kick 1	C2	---
#01	002:Ambi.Kick	C#2	---
#02	012:Syn Kick 3	D2	---
#03	007:Gated Kick	D#2	---
#04	006:Dance Kick	E2	---
#05	005:Real Kick	F2	---
#06	011:Syn Kick 2	F#2	---
#07	030:Syn Snare2	G2	---
#08	028:PowerSnare	G#2	---
#09	029:Syn Snare1	A2	---
#10	019:Soft Snare	A#2	---
#11	021:TightSnare	B2	---
#12	020:LightSnare	C3	---
#13	022:Ambi.Snare	C#3	---
#14	015:Snare 2	D3	---
#15	030:Gun Shot	D#3	---
#16	095:Syn Claps	E3	---
#17	086:Cowbell	F3	---
#18	048:Tite HH	F#3	EX1
#19	051:CloseSynHH	G3	EX2
#20	050:Pedal HH	G#3	EX1
#21	052:Open SynHH	A3	EX2
#22	049:Open HH	A#3	EX1
#23	084:OpenTriang	B3	---
#24	040:Crash Cym	C4	---
#25	044:Splash Cym	C#4	---
#26	084:OpenTriang	D4	---
#27	085:Tambourine	D#4	---
#28	083:MuteTriang	E4	---
#29	071:Open Conga	F4	---
#30	071:Open Conga	F#4	---
#31	072:Slap Conga	G4	---
#32	072:Slap Conga	G#4	---
#33	074:Mute Conga	A4	---
#34	074:Mute Conga	A#4	---
#35	073:Palm Conga	B4	---
#36	066:Lo Bongo	C5	---
#37	087:SynCowbell	C#5	---
#38	068:Slap Bongo	D5	---
#39	070:Syn Claves	D#5	---
#40	082:SynMaracas	E5	---
#41	098:Scratch Hi	F5	---
#42	108:FingerSnap	F#5	---
#43	099:Scratch Lo	G5	---
#44	139:Gt Scratch	G#5	---
#45	100:ScratchDbI	A5	---
#46	085:Agogo	A#5	---
#47	100:ScratchDbI	B5	---
#48	102:Mute Cuica	C6	---
#49	103:Open Cuica	C#6	---
#50	096:Zap 1	D6	---
#51	097:Zap 2	D#6	---
#52	094:Hand Claps	E6	---
#53	135:Pole	F6	---
#54	147: Bell Tree	F#6	---
#55	063:Syn Tom 2	G6	---
#56	063:Syn Tom 2	A6	---
#57	063:Syn Tom 2	B6	---
#58	063:Syn Tom 2	C7	---
#59	030:Syn Snare2	G8	---

ROM Drum Kits

ROM D.Kit 1
GM Kit

#	Inst	Key	Excl
#00	008:ProcesKick	C2	---
#01	036:Side Stick	C#2	---
#02	026:Rock Snare	D2	---
#03	094:Hand Claps	D#2	---
#04	020:LightSnare	E2	---
#05	059:Tom Lo	F2	---
#06	048:Tite HH	F#2	EX1
#07	059:Tom Lo	G2	---
#08	050:Pedal HH	G#2	EX1
#09	059:Tom Lo	A2	---
#10	049:Open HH	A#2	EX1
#11	058:Tom Hi	B2	---
#12	058:Tom Hi	C3	---
#13	040:Crash Cym	C#3	---
#14	048:Tom Hi	D3	---
#15	054:Ride Edge	D#3	---
#16	042:China Cym	E3	---
#17	055:Ride Cup	F3	---
#18	085:Tambourine	F#3	---
#19	044:Splash Cym	G3	---
#20	086:Cowbell	G#3	---
#21	040:Crash Cym	A3	---
#22	104:Vibraslap	A#3	---
#23	056:Ride Cym 1	B3	---
#24	067:Hi Bongo	C4	---
#25	066:Lo Bongo	C#4	---
#26	074:Mute Conga	D4	---
#27	071:Open Conga	D#4	---
#28	071:Open Conga	E4	---
#29	089:Hi Timbal	F4	---
#30	090:Lo Timbal	F#4	---
#31	065:Agogo	G4	---
#32	065:Agogo	G#4	---
#33	081:Cabasa	A4	---
#34	080:Maracas	A#4	---
#35	150:Whistle S	B4	EX2
#36	151:Whistle L	C5	EX2
#37	105:Guiro S	C#5	EX3
#38	106:Guiro L	D5	EX3
#39	069:Claves	D#5	---
#40	092:WoodBlock2	E5	---
#41	093:WoodBlock3	F5	---
#42	102:Mute Cuica	F#5	EX4
#43	103:Open Cuica	G5	EX4
#44	083:MuteTriang	G#5	EX5
#45	084:OpenTriang	A5	EX5
#46	081:Cabasa	A#5	---
#47	005:Real Kick	B1	---
#48	149:JingleBell	B5	---
#49	147:Bell Tree	C6	---
#50	107:Castanet	C#6	---
#51	036:Side Stick	D6	---
#52	154:Taiko Lo	D#6	---
#53	014:Snare 1	A1	EX6
#54	000:Fat Kick	G1	---
#55	016:Snare 3	F1	---
#56	001:Rock Kick	E1	---
#57	049:Open HH	F#1	EX1
#58	109:Timbales	G#1	---
#59	024:RollSnare1	A#1	EX6

ROM D.Kit 2
Power Kit

#	Inst	Key	Excl
#00	009:Metal Kick	C2	---
#01	036:Side Stick	C#2	---
#02	028:PowerSnare	D2	---
#03	094:Hand Claps	D#2	---
#04	027:GatedSnare	E2	---
#05	060:ProcessTom	F2	---
#06	048:Tite HH	F#2	EX1
#07	060:ProcessTom	G2	---
#08	050:Pedal HH	G#2	EX1
#09	060:ProcessTom	A2	---
#10	049:Open HH	A#2	EX1
#11	060:ProcessTom	B2	---
#12	060:ProcessTom	C3	---
#13	040:Crash Cym	C#3	---
#14	060:ProcessTom	D3	---
#15	054:Ride Edge	D#3	---
#16	042:China Cym	E3	---
#17	055:Ride Cup	F3	---
#18	085:Tambourine	F#3	---
#19	044:Splash Cym	G3	---
#20	086:Cowbell	G#3	---
#21	040:Crash Cym	A3	---
#22	104:Vibraslap	A#3	---
#23	056:Ride Cym 1	B3	---
#24	067:Hi Bongo	C4	---
#25	066:Lo Bongo	C#4	---
#26	074:Mute Conga	D4	---
#27	071:Open Conga	D#4	---
#28	071:Open Conga	E4	---
#29	089:Hi Timbal	F4	---
#30	090:Lo Timbal	F#4	---
#31	065:Agogo	G4	---
#32	065:Agogo	G#4	---
#33	081:Cabasa	A4	---
#34	080:Maracas	A#4	---
#35	150:Whistle S	B4	EX2
#36	151:Whistle L	C5	EX2
#37	105:Guiro S	C#5	EX3
#38	106:Guiro L	D5	EX3
#39	069:Claves	D#5	---
#40	092:WoodBlock2	E5	---
#41	093:WoodBlock3	F5	---
#42	102:Mute Cuica	F#5	EX4
#43	103:Open Cuica	G5	EX4
#44	083:MuteTriang	G#5	EX5
#45	084:OpenTriang	A5	EX5
#46	081:Cabasa	A#5	---
#47	007:Gated Kick	B1	---
#48	149:JingleBell	B5	---
#49	147:Bell Tree	C6	---
#50	107:Castanet	C#6	---
#51	036:Side Stick	D6	---
#52	154:Taiko Lo	D#6	---
#53	021:TightSnare	A1	---
#54	007:Gated Kick	G1	---
#55	026:Rock Snare	F1	---
#56	002:Ambi.Kick	E1	---
#57	049:Open HH	F#1	EX1
#58	109:Timbales	G#1	---
#59	023:Rev Snare	A#1	---

ROM D.Kit 3
Analog Kit

#	Inst	Key	Excl
#00	010:Syn Kick 1	C2	---
#01	037:Syn Rim	C#2	---
#02	029:Syn Snare1	D2	---
#03	095:Syn Claps	D#2	---
#04	020:LightSnare	E2	---
#05	062:SynTom1 Lo	F2	---
#06	051:CloseSynHH	F#2	EX1
#07	062:SynTom1 Lo	G2	---
#08	051:CloseSynHH	G#2	EX1
#09	062:SynTom1 Lo	A2	---
#10	052:Open SynHH	A#2	EX1
#11	062:SynTom1 Lo	B2	---
#12	062:SynTom1 Lo	C3	---
#13	052:Open SynHH	C#3	---
#14	062:SynTom1 Lo	D3	---
#15	054:Ride Edge	D#3	---
#16	042:China Cym	E3	---
#17	055:Ride Cup	F3	---
#18	085:Tambourine	F#3	---
#19	044:Splash Cym	G3	---
#20	087:SynCowbell	G#3	---
#21	040:Crash Cym	A3	---
#22	104:Vibraslap	A#3	---
#23	056:Ride Cym 1	B3	---
#24	067:Hi Bongo	C4	---
#25	066:Lo Bongo	C#4	---
#26	081:SynTom1 Hi	D4	---
#27	061:SynTom1 Hi	D#4	---
#28	061:SynTom1 Hi	E4	---
#29	089:Hi Timbal	F4	---
#30	090:Lo Timbal	F#4	---
#31	065:Agogo	G4	---
#32	065:Agogo	G#4	---
#33	081:Cabasa	A4	---
#34	082:SynMaracas	A#4	---
#35	150:Whistle S	B4	EX2
#36	151:Whistle L	C5	EX2
#37	105:Guiro S	C#5	EX3
#38	106:Guiro L	D5	EX3
#39	070:Syn Claves	D#5	---
#40	092:WoodBlock2	E5	---
#41	093:WoodBlock3	F5	---
#42	102:Mute Cuica	F#5	EX4
#43	103:Open Cuica	G5	EX4
#44	083:MuteTriang	G#5	EX5
#45	084:OpenTriang	A5	EX5
#46	081:Cabasa	A#5	---
#47	003:Crisp Kick	B1	---
#48	149:JingleBell	B5	---
#49	147:Bell Tree	C6	---
#50	107:Castanet	C#6	---
#51	036:Side Stick	D6	---
#52	154:Taiko Lo	D#6	---
#53	022:Ambi.Snare	A1	---
#54	006:Dance Kick	G1	---
#55	030:Syn Snare2	F1	---
#56	012:Syn Kick 3	E1	---
#57	052:Open SynHH	F#1	EX1
#58	108:Timbales	G#1	---
#59	023:Rev Snare	A#1	---

ROM D.Kit 4
Jazz Kit

#	Inst	Key	Excl
#00	001:Rock Kick	C2	---
#01	036:Side Stick	C#2	---
#02	019:Soft Snare	D2	---
#03	094:Hand Claps	D#2	---
#04	015:Snare 2	E2	---
#05	059:Tom Lo	F2	---
#06	048:Tite HH	F#2	EX1
#07	059:Tom Lo	G2	---
#08	050:Pedal HH	G#2	EX1
#09	059:Tom Lo	A2	---
#10	049:Open HH	A#2	EX1
#11	058:Tom Hi	B2	---
#12	058:Tom Hi	C3	---
#13	040:Crash Cym	C#3	---
#14	048:Tom Hi	D3	---
#15	057:Ride Cym 2	D#3	---
#16	042:China Cym	E3	---
#17	056:Ride Cym 1	F3	---
#18	085:Tambourine	F#3	---
#19	044:Splash Cym	G3	---
#20	086:Cowbell	G#3	---
#21	040:Crash Cym	A3	---
#22	104:Vibraslap	A#3	---
#23	054:Ride Edge	B3	---
#24	067:Hi Bongo	C4	---
#25	066:Lo Bongo	C#4	---
#26	074:Mute Conga	D4	---
#27	071:Open Conga	D#4	---
#28	071:Open Conga	E4	---
#29	089:Hi Timbal	F4	---
#30	090:Lo Timbal	F#4	---
#31	065:Agogo	G4	---
#32	065:Agogo	G#4	---
#33	081:Cabasa	A4	---
#34	080:Maracas	A#4	---
#35	150:Whistle S	B4	EX2
#36	151:Whistle L	C5	EX2
#37	105:Guiro S	C#5	EX3
#38	106:Guiro L	D5	EX3
#39	069:Claves	D#5	---
#40	092:WoodBlock2	E5	---
#41	093:WoodBlock3	F5	---
#42	102:Mute Cuica	F#5	EX4
#43	103:Open Cuica	G5	EX4
#44	083:MuteTriang	G#5	EX5
#45	084:OpenTriang	A5	EX5
#46	081:Cabasa	A#5	---
#47	004:Punch Kick	B1	---
#48	149:JingleBell	B5	---
#49	147:Bell Tree	C6	---
#50	107:Castanet	C#6	---
#51	036:Side Stick	D6	---
#52	154:Taiko Lo	D#6	---
#53	025:RollSnare2	A1	EX6
#54	002:Ambi.Kick	G1	---
#55	017:Snare 4	F1	---
#56	003:Crisp Kick	E1	---
#57	049:Open HH	F#1	EX1
#58	109:Timbales	G#1	---
#59	024:RollSnare1	A#1	EX6

ROM D.Kit 5**Bruch Kit**

#	Inst	Key	Excl
#00	001:Rock Kick	C2	---
#01	038:Side Stick	C#2	---
#02	035:Brush Tap	D2	---
#03	032:Brush Slap	D#2	---
#04	033:BrushSwish	E2	---
#05	064:Brush Tom	F2	---
#06	048:Tite HH	F#2	EX1
#07	064:Brush Tom	G2	---
#08	050:Pedal HH	G#2	EX1
#09	064:Brush Tom	A2	---
#10	049:Open HH	A#2	EX1
#11	064:Brush Tom	B2	---
#12	064:Brush Tom	C3	---
#13	040:Crash Cym	C#3	---
#14	064:Brush Tom	D3	---
#15	057:Ride Cym 2	D#3	---
#16	042:China Cym	E3	---
#17	056:Ride Cym 1	F3	---
#18	085:Tambourine	F#3	---
#19	044:Splash Cym	G3	---
#20	086:Cowbell	G#3	---
#21	040:Crash Cym	A3	---
#22	104:Vibraslap	A#3	---
#23	054:Ride Edge	B3	---
#24	067:Hi Bongo	C4	---
#25	066:Lo Bongo	C#4	---
#26	074:Mute Conga	D4	---
#27	071:Open Conga	D#4	---
#28	071:Open Conga	E4	---
#29	089:Hi Timbal	F4	---
#30	090:Lo Timbal	F#4	---
#31	065:Agogo	G4	---
#32	065:Agogo	G#4	---
#33	081:Cabasa	A4	---
#34	080:Maracas	A#4	---
#35	150:Whistle S	B4	EX2
#36	151:Whistle L	C5	EX2
#37	105:Güiro S	C#5	EX3
#38	106:Güiro L	D5	EX3
#39	069:Claves	D#5	---
#40	092:WoodBlock2	E5	---
#41	093:WoodBlock3	F5	---
#42	102:Mute Cuica	F#5	EX4
#43	103:Open Cuica	G5	EX4
#44	083:MuteTriang	G#5	EX5
#45	084:OpenTriang	A5	EX5
#46	081:Cabasa	A#5	---
#47	004:Punch Kick	B1	---
#48	149:JingleBell	B5	---
#49	147:Bell Tree	C6	---
#50	107:Castanet	C#6	---
#51	038:Side Stick	D6	---
#52	154:Taiko Lo	D#6	---
#53	032:Brush Slap	A1	EX6
#54	002:Ambi.Kick	G1	---
#55	108:FingerSnap	F1	---
#56	003:Crisp Kick	E1	---
#57	049:Open HH	F#1	EX1
#58	109:Timbales	G#1	---
#59	024:RollSnare1	A#1	EX6

ROM D.Kit 6**Percussion Kit**

#	Inst	Key	Excl
#00	089:Claves	C2	---
#01	092:WoodBlock2	C#2	---
#02	086:Cowbell	D2	---
#03	091:WoodBlock1	D#2	---
#04	107:Castanet	E2	---
#05	076:Baya 2	F2	---
#06	081:Cabasa	F#2	---
#07	075:Baya 1	G2	---
#08	080:Maracas	G#2	---
#09	076:Baya 2	A2	---
#10	081:Cabasa	A#2	---
#11	079:Tabla 3	B2	EX1
#12	078:Tabla 2	C3	EX1
#13	104:Vibraslap	C#3	---
#14	077:Tabla 1	D3	EX1
#15	083:MuteTriang	D#3	EX3
#16	013:Orch B.Drm	E3	---
#17	084:OpenTriang	F3	EX3
#18	105:Güiro S	F#3	EX2
#19	149:JingleBell	G3	---
#20	106:Güiro L	G#3	EX2
#21	147:Bell Tree	A3	---
#22	101:Thing	A#3	---
#23	080:Maracas	B3	---
#24	094:Hand Claps	C4	---
#25	095:Syn Claps	C#4	---
#26	099:Scratch Lo	D4	---
#27	098:Scratch Hi	D#4	---
#28	100:ScratchDb1	E4	---
#29	150:Whistle S	F4	EX4
#30	151:Whistle L	F#4	EX4
#31	072:Slap Conga	G4	---
#32	074:Mute Conga	G#4	---
#33	071:Open Conga	A4	---
#34	071:Open Conga	A#4	---
#35	102:Mute Cuica	B4	---
#36	103:Open Cuica	C5	---
#37	109:Timbales	C#5	---
#38	088:R- Timbal	D5	---
#39	089:Hi Timbal	D#5	---
#40	090:Lo Timbal	E5	---
#41	070:Syn Claves	F5	---
#42	087:SynCowbell	F#5	---
#43	108:FingerSnap	G5	---
#44	153:Taiko Hi	G#5	---
#45	154:Taiko Lo	A5	---
#46	097:Zap 2	A#5	---
#47	093:WoodBlock3	B1	---
#48	024:RollSnare1	B5	EX5
#49	025:RollSnare2	C6	EX5
#50	046:Orch Crash	C#6	EX6
#51	046:Orch Crash	D6	EX6
#52	161:Orch Hit	A7	---
#53	068:Slap Bongo	A#1	---
#54	065:Agogo	A1	---
#55	038:VocalSnr 1	G#1	---
#56	065:Agogo	G1	---
#57	067:Hi Bongo	E1	---
#58	066:Lo Bongo	F1	---
#59	085:Tambourine	F#1	---

ROM D.Kit 7**Dance Kit**

#	Inst	Key	Excl
#00	006:Dance Kick	C2	---
#01	038:Side Stick	C#2	---
#02	030:Syn Snare2	D2	---
#03	094:Hand Claps	D#2	---
#04	022:Ambi.Snare	E2	---
#05	060:ProcessTom	F2	---
#06	048:Tite HH	F#2	EX1
#07	060:ProcessTom	G2	---
#08	050:Pedal HH	G#2	EX1
#09	060:ProcessTom	A2	---
#10	049:Open HH	A#2	EX1
#11	060:ProcessTom	B2	---
#12	060:ProcessTom	C3	---
#13	040:Crash Cym	C#3	---
#14	060:ProcessTom	D3	---
#15	054:Ride Edge	D#3	---
#16	042:China Cym	E3	---
#17	055:Ride Cup	F3	---
#18	085:Tambourine	F#3	---
#19	044:Splash Cym	G3	---
#20	086:Cowbell	G#3	---
#21	040:Crash Cym	A3	---
#22	104:Vibraslap	A#3	---
#23	054:Ride Edge	B3	---
#24	067:Hi Bongo	C4	---
#25	066:Lo Bongo	C#4	---
#26	074:Mute Conga	D4	---
#27	071:Open Conga	D#4	---
#28	071:Open Conga	E4	---
#29	089:Hi Timbal	F4	---
#30	090:Lo Timbal	F#4	---
#31	065:Agogo	G4	---
#32	065:Agogo	G#4	---
#33	081:Cabasa	A4	---
#34	080:Maracas	A#4	---
#35	150:Whistle S	B4	EX2
#36	151:Whistle L	C5	EX2
#37	105:Güiro S	C#5	EX3
#38	106:Güiro L	D5	EX3
#39	069:Claves	D#5	---
#40	092:WoodBlock2	E5	---
#41	093:WoodBlock3	F5	---
#42	102:Mute Cuica	F#5	EX4
#43	103:Open Cuica	G5	EX4
#44	083:MuteTriang	G#5	EX5
#45	084:OpenTriang	A5	EX5
#46	081:Cabasa	A#5	---
#47	002:Ambi.Kick	B1	---
#48	149:JingleBell	B5	---
#49	147:Bell Tree	C6	---
#50	107:Castanet	C#6	---
#51	038:Side Stick	D6	---
#52	154:Taiko Lo	D#6	---
#53	021:TightSnare	A1	---
#54	011:Syn Kick 2	G1	---
#55	018:PicloSnare	F1	---
#56	003:Crisp Kick	E1	---
#57	049:Open HH	F#1	EX1
#58	038:Side Stick	G#1	---
#59	023:Rev Snare	A#1	---

ROM D.Kit 8**Orchestra Kit**

#	Inst	Key	Excl
#00	013:Orch B.Drm	C2	---
#01	038:Side Stick	C#2	---
#02	025:RollSnare2	D2	---
#03	107:Castanet	D#2	---
#04	025:RollSnare2	E2	---
#05	- No Assign -	F2	---
#06	- No Assign -	F#2	---
#07	- No Assign -	G2	---
#08	- No Assign -	G#2	---
#09	- No Assign -	A2	---
#10	- No Assign -	A#2	---
#11	- No Assign -	B2	---
#12	- No Assign -	C3	---
#13	- No Assign -	C#3	---
#14	- No Assign -	D3	---
#15	- No Assign -	D#3	---
#16	- No Assign -	E3	---
#17	152:Timpani	F3	---
#18	085:Tambourine	F#3	---
#19	044:Splash Cym	G3	---
#20	086:Cowbell	G#3	---
#21	040:Crash Cym	A3	---
#22	104:Vibraslap	A#3	---
#23	048:Orch Crash	B3	---
#24	067:Hi Bongo	C4	---
#25	066:Lo Bongo	C#4	---
#26	074:Mute Conga	D4	---
#27	071:Open Conga	D#4	---
#28	071:Open Conga	E4	---
#29	089:Hi Timbal	F4	---
#30	090:Lo Timbal	F#4	---
#31	065:Agogo	G4	---
#32	065:Agogo	G#4	---
#33	081:Cabasa	A4	---
#34	080:Maracas	A#4	---
#35	150:Whistle S	B4	EX2
#36	151:Whistle L	C5	EX2
#37	105:Güiro S	C#5	EX3
#38	106:Güiro L	D5	EX3
#39	069:Claves	D#5	---
#40	092:WoodBlock2	E5	---
#41	093:WoodBlock3	F5	---
#42	102:Mute Cuica	F#5	EX4
#43	103:Open Cuica	G5	EX4
#44	083:MuteTriang	G#5	EX5
#45	084:OpenTriang	A5	EX5
#46	081:Cabasa	A#5	---
#47	005:Real Kick	B1	---
#48	149:JingleBell	B5	---
#49	147:Bell Tree	C6	---
#50	107:Castanet	C#6	---
#51	038:Side Stick	D6	---
#52	154:Taiko Lo	D#6	---
#53	048:Tite HH	D#1	EX1
#54	049:Open HH	F1	EX1
#55	054:Ride Edge	F#1	---
#56	050:Pedal HH	E1	EX1
#57	- No Assign -	D0	---
#58	- No Assign -	G#1	---
#59	- No Assign -	A#1	---

Multisounds

000 A.Piano 1	060 Over Drive	120 Pole	180 White Pad	240 Tite HH NT	300 Mute Conga
001 A.Piano1LP	061 OverDrv LP	121 Pole LP	181 Ether Bell	241 Bell Ride	301 Tabla 1
002 A.Piano 2	062 OverDrv F4	122 Tubular	182 E.Bell LP	242 Ping Ride	302 Tabla 2
003 E.Piano 1	063 MuteDstGtr	123 Split Drum	183 Mega Pad	243 Timpani	303 Maracas
004 E.Piano1LP	064 MtDstGtr V	124 Split Bell	184 Spectrum 1	244 Timpani LP	304 SynMaracas
005 E.Piano 2	065 PowerChord	125 Flute	185 Spectrum 2	245 Cabasa	305 SynMarcsNT
006 E.Piano2LP	066 PowerChd V	126 Pan Flute	186 Stadium	246 Cabasa NT	306 MuteTriang
007 Soft EP	067 OverDvChrd	127 PanFluteLP	187 Stadium NT	247 Agogo	307 OpenTriang
008 Soft EP LP	068 Gtr Slide	128 Shakuhachi	188 BrushNoise	248 Cow Bell	308 Guiro
009 Hard EP	069 GtrSlide V	129 ShakhachLP	189 BruNoiseNT	249 Low Bongo	309 Guiro LP
010 Hard EP LP	070 Sitar 1	130 Bottle	190 Steel Drum	250 Claves	310 Scratch Hi
011 PianoPad 1	071 Sitar 2	131 Recorder	191 SteelDrmlLP	251 Timbale	311 ScratchHINT
012 PianoPad 2	072 Sitar 2 LP	132 Ocarina	192 BrushSwirl	252 WoodBlock1	312 Scratch Lo
013 Clav	073 Santur	133 Oboe	193 Belltree	253 WoodBlock2	313 ScratchLoNT
014 Clav LP	074 Bouzouki	134 EnglishHrn	194 BelltreeNT	254 WoodBlock3	314 ScratchDbI
015 Harpsicord	075 BouzoukiLP	135 Eng.HornLP	195 BeltreV NT	255 Taiko Hit	315 ScratchDbINT
016 HarpsicdLP	076 Banjo	136 BasoonOboe	196 Tri Roll	256 Syn Claves	316 Mini 1a
017 PercOrgan1	077 Shamisen	137 BsonOboeLP	197 TriRoll NT	257 Melo Tom	317 Digital 1
018 PercOrg1LP	078 Koto	138 Clarinet	198 Telephon	258 ProccesTom	318 VS 102
019 PercOrgan2	079 Uood	139 ClarinetLP	199 TelephonNT	259 Syn Tom 1	319 VS 48
020 PercOrg2LP	080 Harp	140 Bari Sax	200 Clicker	260 Syn Tom 2	320 VS 52
021 Organ 1	081 MandlinTrm	141 Bari.SaxLP	201 Clicker NT	261 VocalSnare	321 VS 58
022 Organ 1 LP	082 A.Bass 1	142 Tenor Sax	202 Crickets 1	262 Zap 1	322 VS 71
023 Organ 2	083 A.Bass1 LP	143 T.Sax LP	203 Crickets1NT	263 Zap 2	323 VS 72
024 Organ 2 LP	084 A.Bass 2	144 Alto Sax	204 Crickets 2	264 Fret Zap 1	324 VS 88
025 Organ 3	085 A.Bass2 LP	145 A.Sax LP	205 Crickets2NT	265 Fret Zap 2	325 VS 89
026 Organ 4	086 E.Bass 1	146 SopranoSax	206 Magic Bell	266 Vibra Slap	326 13 - 35
027 Organ 5	087 E.Bass1 LP	147 S.Sax LP	207 Sporing	267 Indust	327 DWGSOrgan1
028 RotaryOrg1	088 E.Bass 2	148 Tuba	208 Rattle	268 Thing	328 DWGSOrgan2
029 RotaryOrg2	089 E.Bass2 LP	149 Tuba LP	209 Kava 1	269 Thing NT	329 DWGS E.P.
030 PipeOrgan1	090 Pick Bass1	150 Horn	210 Kava 2	270 FingerSnap	330 Saw
031 PipeOrg1LP	091 PicBass1LP	151 FlugelHorn	211 Fever 1	271 FingSnapNT	331 Square
032 PipeOrgan2	092 Pick Bass2	152 Trombone 1	212 Fever 2	272 Tambourine	332 Ramp
033 PipeOrg2LP	093 Fretless	153 Trombone 2	213 Zappers 1	273 Hand Clap	333 Pulse 25%
034 PipeOrgan3	094 FretlessLP	154 Trumpet	214 Zappers 2	274 HandClapNT	334 Pulse 8%
035 PipeOrg3LP	095 Slap Bass1	155 Trumpet LP	215 Bugs	275 Gun Shot	335 Pulse 4%
036 Musette	096 Slap Bass2	156 Mute TP	216 Surfy	276 Castanet	336 Syn Sine
037 Musette V	097 SlpBass2LP	157 Mute TP LP	217 SleighBell	277 CastanetNT	337 Sine
038 Bandneon	098 Slap Bass3	158 Brass 1	218 Elec Beat	278 Snap	338 DJ Kit 1
039 BandneonLP	099 SynthBass1	159 Brass 1 LP	219 Idling	279 Snap NT	339 DJ Kit 2
040 Accordion	100 SynBass1LP	160 Brass 2	220 EthnicBeat	280 Gt Scratch	340 Piano *
041 AcordionLP	101 SynthBass2	161 Brass 2 LP	221 Taps	281 Side Stick	
042 Harmonica	102 SynBass2LP	162 StringEns.	222 Tap 1	282 SideStikNT	
043 G.Guitar	103 House Bass	163 StrEns. V1	223 Tap 2	283 TimbleSide	
044 G.GuitarLP	104 FM Bass	164 StrEns. V2	224 Tap 3	284 TimbISidNT	
045 F.Guitar	105 FM Bass LP	165 StrEns. V3	225 Tap 4	285 Syn Rim	
046 F.GuitarLP	106 Kalimba	166 AnaStrings	226 Tap 5	286 Syn Rim NT	
047 F.Guitar V	107 Music Box	167 PWM	227 Orch Hit	287 Open HH	
048 A.Gtr Harm	108 MusicBoxLP	168 Violin	228 SnareRI/Ht	288 OpenSyn HH	
049 E.Guitar 1	109 Log Drum	169 Cello	229 Syn Snare	289 CloseSynHH	
050 E.Guitr1 V	110 Marimba	170 Cello LP	230 Rev Snare	290 Sagat	
051 E.Guitar 2	111 Xylophone	171 Pizzicato	231 PowerSnare	291 Sagat NT	
052 E.Guitar 3	112 Vibe	172 Voice	232 Orch Perc	292 Sagatty	
053 MuteGuitar	113 Celesta	173 Choir	233 Crash Cym	293 Sagatty NT	
054 Funky Gtr	114 Glocken	174 Soft Choir	234 CrashCymLP	294 JingleBell	
055 FunkyGtr V	115 BrightBell	175 Air Vox	235 CrashLP NT	295 Taiko	
056 E.Gtr Harm	116 B.Bell LP	176 Doo Voice	236 China Cym	296 Slap Bongo	
057 DistGuitar	117 Metal Bell	177 DooVoiceLP	237 Splash Cym	297 Open Conga	
058 Dist GtrLP	118 M.Bell LP	178 Syn Vox	238 Orch Crash	298 Slap Conga	
059 DistGuitrV	119 Gamelan	179 Syn Vox LP	239 Tite HH	299 Palm Conga	

* =X2 only

Drum Sounds

000 Fat Kick	030 Syn Snare2	060 ProcessTom	090 Lo Timbal	120 Log Drum 2	150 Whistle S
001 Rock Kick	031 Gun Shot	061 SynTom1 Hi	091 WoodBlock1	121 Log Drum 3	151 Whistle L
002 Ambi.Kick	032 Brush Slap	062 SynTom1 Lo	092 WoodBlock2	122 Log Drum 4	152 Timpani
003 Crisp Kick	033 BrushSwish	063 Syn Tom 2	093 WoodBlock3	123 Log Drum 5	153 Taiko Hi
004 Punch Kick	034 BrushSwirl	064 Brush Tom	094 Hand Claps	124 Snap	154 Taiko Lo
005 Real Kick	035 Brush Tap	065 Agogo	095 Syn Claps	125 BrightBell	155 Music Box1
006 Dance Kick	036 Side Stick	066 Lo Bongo	096 Zap 1	126 Metal Bell	156 Music Box2
007 Gated Kick	037 Syn Rim	067 Hi Bongo	097 Zap 2	127 Gamelan 1	157 Clicker 1
008 ProcesKick	038 VocalSnr 1	068 Slap Bongo	098 Scratch Hi	128 Gamelan 2	158 Clicker 2
009 Metal Kick	039 VocalSnr 2	069 Claves	099 Scratch Lo	129 Celeste	159 Clicker 3
010 Syn Kick 1	040 Crash Cym	070 Syn Claves	100 ScratchDbf	130 Glocken	160 Crickets
011 Syn Kick 2	041 Crash LP	071 Open Conga	101 Thing	131 Vibe 1	161 Orch Hit
012 Syn Kick 3	042 China Cym	072 Slap Conga	102 Mute Cuica	132 Vibe 2	162 Metronome1
013 Orch B.Drm	043 China LP	073 Palm Conga	103 Open Cuica	133 Vibe 3	163 Metronome2
014 Snare 1	044 Splash Cym	074 Mute Conga	104 Vibraslap	134 Vibe 4	
015 Snare 2	045 Splash LP	075 Baya 1	105 Guiro S	135 Pole	
016 Snare 3	046 Orch Crash	076 Baya 2	106 Guiro L	136 TubulBell1	
017 Snare 4	047 OrchCym LP	077 Tabla 1	107 Castanet	137 TubulBell2	
018 PicloSnare	048 Tite HH	078 Tabla 2	108 FingerSnap	138 TubulBell3	
019 Soft Snare	049 Open HH	079 Tabla 3	109 Timbales	139 Gt Scratch	
020 LightSnare	050 Pedal HH	080 Maracas	110 Kalimba 1	140 Chic 1	
021 TightSnare	051 CloseSynHH	081 Cabasa	111 Kaliimba 2	141 Chic 2	
022 Ambi.Snare	052 Open SynHH	082 SynMaracas	112 Marimba 1	142 Spectrum 1	
023 Rev Snare	053 Sagat	083 MuteTriang	113 Marimba 2	143 Spectrum 2	
024 RollSnare1	054 Ride Edge	084 OpenTriang	114 Marimba 3	144 Stadium	
025 RollSnare2	055 Ride Cup	085 Tambourine	115 Marimba 4	145 BrushNoise	
026 Rock Snare	056 Ride Cym 1	086 Cowbell	116 Xylofon 1	146 Gt Slide	
027 GatedSnare	057 Ride Cym 2	087 SynCowbell	117 Xylofon 2	147 Bell Tree	
028 PowerSnare	058 Tom Hi	088 R - Timbal	118 Xylofon 3	148 Tri Roll	
029 Syn Snare1	059 Tom Lo	089 Hi Timbal	119 Log Drum 1	149 JingleBell	

NOTICE

KORG products are manufactured under strict specifications and voltages required by each country. These products are warranted by the KORG distributor only in each country. Any KORG product not sold with a warranty card or carrying a serial number disqualifies the product sold from the manufacturer's/distributor's warranty and liability. This requirement is for your own protection and safety.

KORG KORG INC.

15 - 12, Shimotakaido 1 - chome, Suginami-ku, Tokyo, Japan.