

OASYS

Open Architecture Synthesis Studio

OASYS

Open Architecture Synthesis Studio

Operation Guide

Please read this guide first



 OPEN ARCHITECTURE SYNTHESIS SYSTEM  EXPANSION INSTRUMENTS  EXPANSION SAMPLES  EXPANSION EFFECTS

 KARMA KAY ALGORITHMIC REALTIME MUSIC ARCHITECTURE  REMS  GENERAL MIDI  CD-RW  USB2.0

 TouchView Graphical User Interface  SONDIUS-XG  CMT

KORG

IMPORTANT SAFETY INSTRUCTIONS

- Read these instructions.
- Keep these instructions.
- Heed all warnings.
- Follow all instructions.
- Do not use this apparatus near water.
- Mains powered apparatus shall not be exposed to dripping or splashing and that no objects filled with liquids, such as vases, shall be placed on the apparatus.
- Clean only with dry cloth.
- Do not block any ventilation openings, install in accordance with the manufacturer's instructions.
- Do not install near any heat sources such as radiators, heat registers, stoves, or other apparatus (including amplifiers) that produce heat.
- Do not defeat the safety purpose of the polarized or grounding-type plug. A polarized plug has two blades with one wider than the other. A grounding type plug has two blades and a third grounding prong. The wide blade or the third prong are provided for your safety. If the provided plug does not fit into your outlet, consult an electrician for replacement of the obsolete outlet. (for U.S.A. and Canada)
- Protect the power cord from being walked on or pinched particularly at plugs, convenience receptacles, and the point where they exit from the apparatus.
- Only use attachments/accessories specified by the manufacturer.
- Unplug this apparatus during lightning storms or when unused for long periods of time.
- Refer all servicing to qualified service personnel. Servicing is required when the apparatus has been damaged in any way, such as power-supply cord or plug is damaged, liquid has been spilled or objects have fallen into the apparatus, the apparatus has been exposed to rain or moisture, does not operate normally, or has been dropped.
- Do not install this equipment far from a power outlet and/or power strip.
- Do not install this equipment in a confined space, such as a moving box or other enclosure.
- Use only with the cart, stand, tripod, bracket, or table specified by the manufacturer, or sold with the apparatus. When a cart is used, use caution when moving the cart/apparatus combination to avoid injury from tip-over.



WARNING:
TO REDUCE THE RISK OF FIRE OR ELECTRIC SHOCK DO NOT EXPOSE THIS PRODUCT TO RAIN OR MOISTURE.

	CAUTION RISK OF ELECTRIC SHOCK DO NOT OPEN	
AVERTISSEMENT: RISQUE DE CHOC ÉLECTRIQUE—NE PAS OUVRIR.		
注意 感電の恐れあり、キャビネットをあけるな		

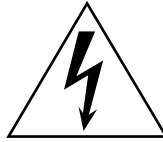

The lightning flash with arrowhead symbol within an equilateral triangle, is intended to alert the user to the presence of uninsulated “dangerous voltage” within the product’s enclosure that may be of sufficient magnitude to constitute a risk of electric shock to persons.



The exclamation point within an equilateral triangle is intended to alert the user to the presence of important operating and maintenance (servicing) instructions in the literature accompanying the product.

CAUTION

Danger of explosion if battery is incorrectly replaced. Replace only with the same or equivalent type.

THE FCC REGULATION WARNING (for U.S.A.)

This equipment has been tested and found to comply with the limits for a Class B digital device, pursuant to Part 15 of the FCC Rules. These limits are designed to provide reasonable protection against harmful interference in a residential installation. This equipment generates, uses, and can radiate radio frequency energy and, if not installed and used in accordance with the instructions, may cause harmful interference to radio communications. However, there is no guarantee that interference will not occur in a particular installation. If this equipment does cause harmful interference to radio or television reception, which can be determined by turning the equipment off and on, the user is encouraged to try to correct the interference by one or more of the following measures:

- Reorient or relocate the receiving antenna.
- Increase the separation between the equipment and receiver.
- Connect the equipment into an outlet on a circuit different from that to which the receiver is connected.
- Consult the dealer or an experienced radio/TV technician for help.

Unauthorized changes or modification to this system can void the user’s authority to operate this equipment.

CE mark for European Harmonized Standards

CE mark which is attached to our company’s products of AC mains operated apparatus until December 31, 1996 means it conforms to EMC Directive (89/336/EEC) and CE mark Directive (93/68/EEC). And, CE mark which is attached after January 1, 1997 means it conforms to EMC Directive (89/336/EEC), CE mark Directive (93/68/EEC) and Low Voltage Directive (73/23/EEC). Also, CE mark which is attached to our company’s products of Battery operated apparatus means it conforms to EMC Directive (89/336/EEC) and CE mark Directive (93/68/EEC).

Handling of the internal hard disk

- Do not apply physical shock to this device. In particular, you must never move this device or apply physical shock while the power is turned on. This can cause part or all of the data on disk to be lost, or may damage the hard disk or interior components.

When this device is moved to a location where the temperature is radically different, water droplets may condense on the hard disk. If the device is used in this condition, it may malfunction, so please allow several hours to pass before operating the device.

Do not turn the power on and off repeatedly. This may damage the OASYS.

This device begins to access the hard disk immediately after the power is turned on.

Never turn off the power while the hard disk is being accessed. Doing so can cause all or part of the data on the hard disk to be lost, or may cause malfunctions such as hard disk damage.

If the hard disk has been damaged due to incorrect operation, power failure, or accidental interruption of the power supply, a fee may be charged for replacement even if this device is still within its warranty period.

Handling of the cooling vents

- The openings on the left and right sides of the unit are cooling vents. If the cooling is inadequate, operation may become unstable and the power supply may shut down. Be sure to place the unit so that the sides are at least 10 cm from a wall or similar object. Do not place any object near the cooling vents that might block them.

CAUTION FOR LASER

This product utilizes a laser.
Use of control, adjustment or performance of procedures other than those specified herein may result in hazardous radiation exposure.
Do not open covers and do not repair yourself.
Refer servicing to qualified personnel.

Laser diode properties

Material	Semiconductor laser GaAlAs
Laser output	Less than HHS and IEC 825-1 Class 1
Limit	
Wave length	784nm

Location of the required label.

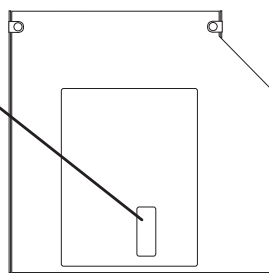

Cautions when using the CD-R/RW drive

- During CD reading and writing operations, keep the unit in a horizontal position.
- Do not use the unit in extremely cold or hot locations.
- Do not use the unit in extremely humid locations.
- Do not use the unit in dusty or smoky locations.
- Do not subject the unit to vibration or strong physical shock. In particular, this unit is vulnerable to shock during CD reading and writing operations.
- Normally, you will be able to open the CD tray by pressing the eject button. However if this fails, you can forcibly eject the tray by inserting a thin object (such as a straightened paper clip) into the emergency eject hole.
- Do not store the unit in hot or humid locations.
- Never touch the focusing lens.
- Do not use commercially available lens cleaners.
- Do not transport the unit with a disc left in the tray.
- Do not leave the unit with the disc tray open.

CD-R/RW handling

Please observe the following points when handling discs. Failure to observe these points may cause problems such as data not being written correctly, loss of recorded data, or drive malfunction.

- Do not leave discs in direct sunlight, or in locations of high temperature or high humidity.
- Do not touch the surface of a disc. Hold a disc by its edges.
- Remove dust or dirt from the surface of a disc. To remove dust, use an air duster or cleaner.
- Do not affix labels to a disc, or write on a disc in locations other than specified.
- Do not use chemicals or detergent to wipe a disc.
- Do not bend or drop a disc.

Responsibility for loss of data

Korg Corporation will accept no responsibility for any damages (direct or indirect, whether sustained by the customer or by a third party) resulting from loss of or damage to data written on a CD-R or CD-RW disc.

Regarding the LCD screen

The LCD screen of the OASYS is a precision device created using extremely high technology, and careful attention has been paid to its product quality. Although you may notice some of the issues listed below, please be aware that these are due to the characteristics of LCD screens, and are not malfunctions.

- There may be pixels in the screen that are always dark (unlit) or always bright (lit).
- Depending on the displayed content, the brightness of the screen may appear uneven.
- Depending on the displayed content, horizontal stripes of shading may be visible.
- Depending on the displayed content, flickering or moire patterns may be visible.

Data handling

Incorrect operation or malfunction may cause the contents of memory to be lost, so we recommend that you save important data on a CD or other media. Please be aware that Korg will accept no responsibility for any damages which may result from loss of data.

Also, when digitally recording copyrighted audio material from a DAT or CD etc., you must obtain permission for use. Please be aware that Korg will accept no responsibility for any copyright violations which may occur through your use of this product.

COPYRIGHT WARNING

This professional device is intended only for use with works for which you yourself own the copyright, for which you have received permission from the copyright holder to publicly perform, record, broadcast, sell, and duplicate, or in connection with activities which constitute "fair use" under copyright law. If you are not the copyright holder, have not received permission from the copyright holder, or have not engaged in fair use of the works, you may be violating copyright law, and may be liable for damages and penalties. If you are unsure about your rights to a work, please consult a copyright attorney. **KORG TAKES NO RESPONSIBILITY FOR ANY INFRINGEMENT COMMITTED THROUGH USE OF KORG PRODUCTS.**

Korg OASYS Notice: Use of GPL and LGPL software

This product uses the Linux kernel and some GNU utilities. This software is licensed by its copyright holder according to the GNU GPL (General Public License).

The Korg OASYS software contained in this product is dynamically linked with some software libraries subject to the LGPL (Lesser GPL) license.

Copies of the GPL and LGPL licenses, as well as the source code for the software covered under those licenses, are provided on the included CD-ROM titled OASYS Restore CD 1/4, in the folder named "src."

The complete list of software covered under the GPL, LGPL, and other free or open-source licenses which are used in the OASYS, including the above software, is included in the same folder.

- These files are provided in accordance with the spirit of free software, and are not required in order to use this product.
- You cannot access these files directly from the OASYS. To read them, you will need to use a separate computer running Windows, MacOS, Linux, or any other operating system capable of reading standard text files and tar, gzip, and bzip2 archives.

The Korg OASYS software is copyright Korg Inc., and is independent of Linux. Its use is covered by the Korg OASYS Software License, described elsewhere in the documentation. The GPL license does not apply to this software, and its source code is not provided.

Korg accepts no responsibility for any direct or consequential damages that may occur due to the use of or the inability to use any of the system software including the above software.

Linux is a trademark or registered trademark of Linus Torvalds in the United States and in other countries.

-
- * KARMA[®] (Kay Algorithmic Realtime Music Architecture) Technology has been licensed from Stephen Kay, and is protected by U.S. Patents 5,486,647, 5,521,327, 6,084,171, 6,087,578, 6,103,964, 6,121,532, 6,121,533, 6,326,538, and 6,639,141. Other patents pending.
 - * KARMA[®] and the KARMA Logo are registered trademarks, and Generated Effect[™] (GE), Melodic Repeat[™], Direct Index[™], Manual Advance[™], SmartScan[™], Freeze Randomize[™], Random Capture[™], Random FF/REW[™] and Scene Matrix[™] are trademarks of Stephen Kay, Karma Lab LLC. This manual copyright © 1994-2004 by KORG Inc. and Stephen Kay. All rights reserved.
 - * Screen shots from the KARMA software that appear throughout this guide are © 1994-2004 by Stephen Kay, Karma Lab LLC. Used by permission. All rights reserved.
 - * KARMA Technology can be located on the internet at: www.karma-lab.com.
 - * This product was developed under license of physical modeling tone generator patents (<http://www.sondius-xg.com>) owned by Stanford University USA and Yamaha Corporation.
 - * Company names, product names, and names of formats etc. are the trademarks or registered trademarks of their respective owners.

Thank you for purchasing the Korg OASYS Open Architecture Synthesis Studio. To help you get the most out of your new instrument, please read this manual carefully.

About this manual

The owner's manuals and how to use them

The OASYS includes two owner's manuals:

- Operation Guide
- Parameter Guide

Both manuals are available as PDFs on Restore CD 1/4, and are included in the on-board Help system. A printed version of the Operation Guide is also included.

Operation Guide

Please read this first. It explains the names and functions of each part of the OASYS, how to make connections, basic operation, an overview of each mode, how to edit sounds, how to record on the sequencer, and how to sample. This guide also explains the KARMA function, effects, wave sequences, and drum kits.

The Operation Guide also contains troubleshooting information, and supplemental information such as specifications.

Parameter Guide

The Parameter Guide contains explanations and other information regarding the operations of the parameters and settings on the OASYS.

The explanations are organized by mode and page. Separate Effects and KARMA sections include explanations of the individual parameters of each effect and each KARMA GE.

Refer to this guide when an unfamiliar parameter appears in the display, or when you need to know more about a particular function.

The Parameter Guide also contains a **Voice Name List** that lists the multisamples, drum samples, combinations, programs, drum kits, and KARMA settings that are in the OASYS when it is shipped from the factory.

PDF versions

The OASYS PDF manuals are designed for easy navigation and searching. They include extensive PDF contents information, which generally appears on the side of the window in your PDF reader and lets you jump quickly to a specific section. All cross-references are hyper-links, so that clicking on them automatically takes you to the source of the reference.

On-board Help system*

The HELP button gives you built-in, context-sensitive access to the user manuals, right from the front panel.

For information on any front-panel button, knob, slider, or real-time controller, just hold down HELP and then press the button or move the controller in question.

For information on the current LCD page, press and release the HELP button.

While the help page is on the screen, you can touch any of the on-screen links (highlighted in blue text) for more information. You can scroll through the text by using the on-screen scroll bars, pressing the Inc and Dec buttons, or spinning the Value dial.

The top of the Help page has "breadcrumb" links, which show the hierarchy of pages above the current one. Touch any of these links to jump to the corresponding page.

The backwards and forwards buttons function like the similar buttons on a standard web browser. If you use links to jump between pages, you can then use the backwards and forwards buttons to move through the pages you've already viewed.

The Contents page lets you access any part of the Help system, including almost all of the text and graphics in both the Parameter and Operation Guides. The Index contains a shorter list of links to important articles.

*English-language only.

Conventions in this manual

References to the OASYS

The OASYS is available as an 88-key model or a 76-key model. The manuals refer to both models without distinction as "the OASYS." The front panel and rear panel illustrations in the manual show the 76-key model, but they apply identically to the 88-key model.

Abbreviations for the manuals: OG, PG, VNL

In the documentation, references to the manuals are abbreviated as follows.

OG: Operation Guide

PG: Parameter Guide

VNL: The Voice Name List, included in the Parameter Guide

Procedure steps 1. 2. 3. ...

These indicate the steps of a procedure.

Symbols , , *Note*, *Tips*

These symbols respectively indicate a caution, a MIDI-related explanation, a supplementary note, or a tip.

Example screen displays

The parameter values shown in the example screens of this manual are only for explanatory purposes, and may not necessarily match the values that appear in the LCD screen of your instrument.

MIDI-related explanations

CC# is an abbreviation for Control Change Number.

In explanations of MIDI messages, numbers in square brackets [] always indicate hexadecimal numbers.

Contents

About this manual. vi

Quick Start 1

Quick Start 1
Setup. 1
Playing Programs and Combinations. 1
Listening to the demo songs. 4
New features in software version 1.2 6
New features in software version 1.1 7

Introduction to OASYS. 9

Main Features. 9
Open Architecture Synthesis Studio 9

Front and rear panels 18
Front panel 18
Rear panel 24
Names and functions
of objects on the LCD display. 27

Basic Information 30
About the OASYS' modes. 30
About the OASYS' PCM memory 31
About polyphony. 33
Basic operations 34

Setup 37
Connections. 37
Turning the power on/off 40
Using the CD-R/RW drive. 41

Playing and editing Programs 43

Selecting Programs. 43
Using Controllers. 45
Using Chord mode. 49
Quick Edits using the Sliders,
Knobs and Switches. 51
Detailed Editing with HD-1 Programs 54
Using LFOs and Envelopes (EGs) 57
Using Alternate Modulation (AMS)
and the AMS Mixers 58
Controlling Pitch 59
Using Filters 60
Using the Amp section 62
Using Vector Synthesis 64
Effects. 65
Automatically importing a Program
into Sequence mode 66

Playing and editing Combinations 67

Combination overview 67
Selecting Combinations. 68
Easy Combination editing. 70

Combination editing 71
Layers, Splits, and Velocity Switches 72
MIDI Settings 73
Altering Programs to fit within a Combination 73
Effects. 74
Automatically importing a Combination
into Sequencer mode. 75
Saving your edits. 75

Creating songs (Sequencer mode) 77

Overview - About the OASYS' sequencer. 77
Sequencer mode structure 77

Playing Songs. 79
Playback 79
The control surface in Sequencer mode 80

MIDI recording 83
Preparations for recording 83
Recording MIDI in real-time 85
MIDI step recording 88
Recording the sound
of a Combination or Program 90
Recording multiple MIDI tracks from
an external sequencer 91
Recording System Exclusive events 92
Recording patterns. 93
Other ways to record. 95

Audio recording 96
Overview: About the
OASYS' hard disk recorder 96
Audio input settings
and recording source selection 97
Recording procedure. 100
Placing a WAVE file in an audio track 108
Song editing 109
Using RPPR (Realtime Pattern Play/Record) 112
Sampling in Sequencer mode. 114
Saving your song 115
Cautions and other functions
in Sequencer mode. 116

Sampling (Open Sampling System) 119

Sampling Overview. 119
Preparations for sampling 121
Sampling and editing in Sampling mode. 126
Sampling in Program, Combination,
and Sequencer modes 141

**Settings for the entire OASYS
(Global mode) 147**

How Global mode is structured 147
P0: Basic Setup 147
Global audio settings. 148

MIDI-related settings P1: MIDI	149
Pedal and other controller settings	149
Creating user scales	150
Setting Category Names for Programs, Combinations, and KARMA	150

Using Wave Sequences151

Wave Sequence Overview	151
Programming Basics	151
Adjusting the sound of an individual step.....	152
Using rhythmic Wave Sequences	154
Creating smooth, evolving timbres.....	156
Modulating Wave Sequences.....	157
Saving Wave Sequences	158

Using Drum Kits159

Drum Kit Overview.....	159
Before you start editing.....	159
Editing Drum Kits	160
Saving Drum Kits.....	161

Loading & saving data, and creating CDs..... 163

Saving data.....163

Types of data that can be saved	163
Writing to internal memory	164
Saving to disks, CDs, and USB media.....	168

Loading data from disk171

Loading .PCG, .SNG, and .KSC files.....	171
Loading individual banks from a .PCG file.....	173
Loading data by individual item or bank.....	173

Creating and playing audio CDs.....175

Creating audio CDs.....	175
Playing audio CDs.....	177

Other disk operations178

Viewing information about media – Disk Media Info	178
Setting the date and time	178
Restoring the factory settings.....	178

Other functions180

Assigning functions to SW1/2 and the REALTIME KNOBS.....	180
Adjusting the brightness, contrast, and color of the LCD.....	180
Using tap tempo.....	181
Resetting controller values	181
Shortcuts	182

Using Effects 183

Routing effect settings.....	185
Dynamic modulation, MIDI/Tempo Sync, and Common FX LFO	191

Using KARMA 193

Overview - What is KARMA?193

Performing with KARMA	196
KARMA function settings	202
Synchronizing the KARMA function	213

Appendices.....215

Troubleshooting.....215

Power supply.....	215
LCD screen	215
Audio input and output.....	216
Programs and Combinations.....	217
Songs.....	218
Sampling.....	219
KARMA.....	220
Vector	220
Drum Kits.....	220
Wave Sequences.....	220
Effects	221
MIDI.....	221
Disks, CDs, and USB Media.....	221
Other problems	222

Media that can be used with the OASYS..... 223

Types of media supported by the OASYS.....	223
Operations that the OASYS can perform on media.....	223

Specifications and options225

MIDI Implementation Chart 231

Quick Start

Quick Start

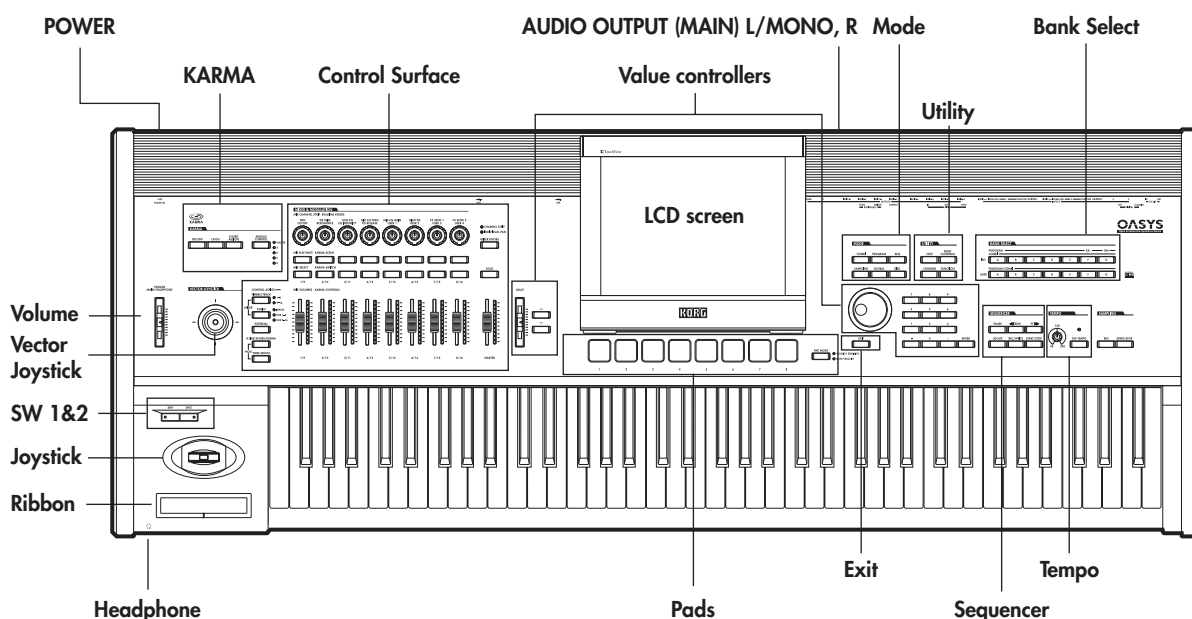

The OASYS contains an amazing amount of functionality, but this Quick Start is provided for those who just want to get started trying out the sounds right away.

It explains how to set up the OASYS, how to select programs and control the sound, how to listen to the demo songs, and the new features of the latest software update.

Setup

1. Connect the OASYS to your mix or monitor system.

Connect the OASYS' AUDIO OUTPUT (MAIN) L/MONO and R jacks to your mixer or amplified monitor speakers.

If you're monitoring through headphones, connect them to the headphone jack located on the left front of the OASYS. The headphones will output the same sound as the AUDIO OUTPUT (MAIN) L/MONO and R jacks.

2. Connect the power cable.

First connect the included power cable to the OASYS' power connector.

3. Turn on the power.

Press the rear panel POWER switch to turn on the power. Wait until the opening screen has finished being displayed.

4. Lower the VOLUME slider, and gradually raise it to an appropriate volume.

Playing Programs and Combinations

With the factory settings, Combination mode will be selected when you turn on the power.

Play the keyboard, and you will hear the sound of bank INT-A combination number 000.

A combination consists of up to sixteen programs that are split and/or layered. It also uses up to four KARMA modules simultaneously (a program can use only one KARMA module), letting you produce far more complex sounds than a program.

Although you could simply continue selecting different combinations and playing them, let's start by selecting and listening to the "basic" sounds of the OASYS – programs.

Selecting Programs by bank and number

1. Press the MODE PROGRAM switch (the LED will light) to enter Program mode.

The upper left of the LCD screen shows the name of the current page, PROGRAM P0: Play. This is the page in which you will normally play programs.

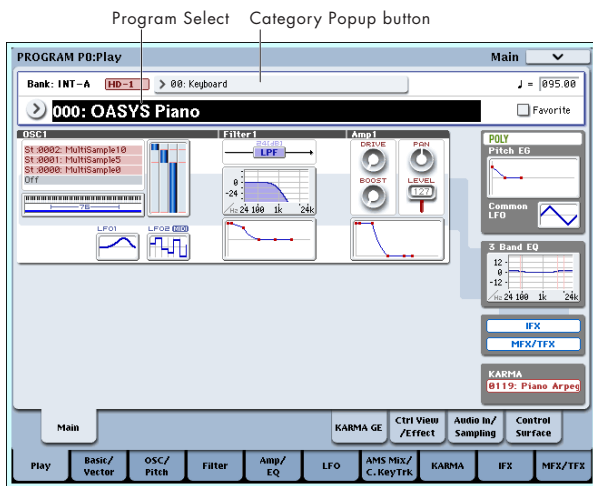

Play the keyboard or strike the pads to hear the sound.

2. The large characters in the upper part of the LCD screen will be highlighted.

These are the program number and program name (“Program Select”).

In this state, you can press the Δ/∇ switches to select the next or previously numbered program.

You can turn the VALUE dial to switch programs in larger steps.

Tip: If you’ve pressed the LCD screen to move to another page, pressing the EXIT switch up to four times will return you to the state in which you can select programs.

3. Use the BANK SELECT INT A–G and USER A–G switches to select programs of other banks.

Selecting Programs by Category

There are other ways to select programs, but here we’ll explain how to select programs by their category, such as keyboard, organ, bass, or drum sounds.

For other ways to select programs, see “Selecting Programs” on page 43.

1. In the LCD screen, press the Category popup button.

This is the rectangle located above the program name. A menu will appear.

2. Use the tabs at the left to select a category.

The space on the right will then show all of the Programs in that category, in all of the internal banks. If you like, you can use sub-categories to narrow the selection:

3. After selecting a category, you can then press one of the inner tabs to select a sub-category.

You won’t be able to select a category or sub-category that hasn’t been assigned to any program.

4. Select a program from the list.

You can either press a program within the list, or use the Δ/∇ switches.

5. If not all the items in the list can be shown in the screen, use the scroll bars to view the rest of the list.

6. When you’ve found a program you like, press the OK button to close the dialog box. Then go ahead and play the selected program!

Program Bank Contents

OASYS ships from the factory with over a thousand Programs loaded into memory. Another 768 Program slots are left open (“initialized”) for your own programming, or additional sound libraries. All of the factory Programs can be over-written with your own edits, if desired—except for the GM banks.

As shipped from the factory, the contents of the Program Banks are as follows:

Program bank contents

Bank	Contents	Bank Type
INT-A...D	Factory Programs	HD-1
INT-E *1	Factory Programs; requires the EXs1 ROM Expansion PCM.	
INT-F	Factory EXi Programs.	EXi
GM (INT-G) *2	GM2 main programs	GM
g(1)...g(9)	GM2 variation programs	
g(d)	GM2 drum programs	
USER-A *1	000...007: Factory Programs; requires the EXs2 Concert Grand Piano PCM. 008, 011...127: Initialized programs.	Bank type can be set to either HD-1 or EXi
USER-B...E, G	Initialized HD-1 Programs.	
USER-F	Factory EXi Programs.	

*1 The factory Programs in INT-E require the EXs1 ROM Expansion PCM; similarly, the factory Programs in USER-A require the EXs2 Concert Grand Piano PCM. If the appropriate EXs data isn’t loaded, the Programs won’t sound correctly.

The factory Combinations in INT-C also require EXs1 to be loaded.

With the factory-installed 1GB of RAM, you can use either EXs1 or EXs2—but not both at the same time. As shipped from the factory, EXs1 is loaded, so the Programs in bank INT-E will play correctly.

For details on how to load EXs data, see “Selecting which EXs PCM data is loaded” on page 32.

*2 You can press the INT G switch repeatedly to cycle through banks GM, g(1)...g(9), and g(d).

Selecting combinations

1. Press the MODE COMBI switch (the LED will light) to enter Combination mode.

Once you’re in Combi mode, you can select and play Combinations in the same way as you did Programs. For more details, see “Selecting Programs by bank and number” on page 1 and “Selecting Programs by Category” on page 2.

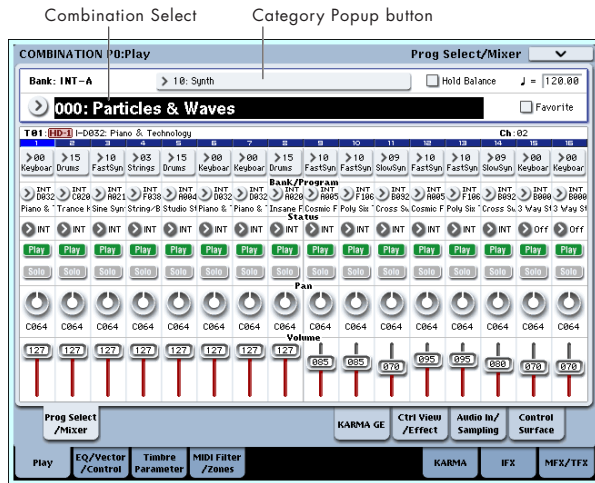

page by pressing the Control Surface tab located in the lower right of the LCD screen.

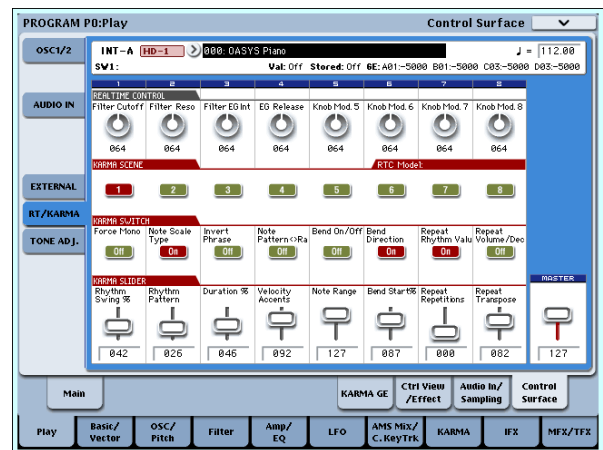

Combination Bank Contents

As shipped from the factory, the contents of the Combination Banks are as follows:

Combination bank contents

Bank	Contents
INT-A, B	Factory Combinations
INT-C	Factory Combinations; requires the EXs1 ROM Expansion PCM.
INT-D...G; USER-A...G	Initialized Combinations

Using controllers to vary the sound

1. Numerous controllers are located in the left side of the OASYS' front panel.

While you play the keyboard, operate the group of controllers located at the far left – the joystick, vector joystick, ribbon controller, and SW1/SW2 switches – to vary the sound.

The result will differ for each program or combination, so try them all out to see what each controller does for the particular program or combination you've selected. For details on these controllers, see "Using Controllers" on page 45.

2. Next, notice the mixer-like arrangement of sliders, knobs, and switches located at the right of these controllers.

This is called the "control surface." You'll use it in a variety of ways, such as editing sounds, controlling the KARMA function, or sending MIDI messages to an external device.

Here we'll explain the R.TIME KNOBS/KARMA functionality of the control surface. Press the CONTROL ASSIGN R.TIME KNOBS/KARMA switch (the LED will light). Now you can use the knobs to modify the sounds and effects, or use the sliders and switches to control the KARMA function.

You can perform these control operations by operating the knobs, switches, and sliders themselves. However, the LCD screen can also show a screen containing the same controller functions and values. Access the Control Surface

When you operate a controller, the corresponding object in the LCD screen will move in the same way. When you turn the eight knobs located at the top of the control surface, the assigned function will occur, and the sound will change accordingly.

Using controllers to vary a KARMA phrase

1. If R.TIME KNOBS/KARMA is selected by the CONTROL ASSIGN buttons, the sliders and switches will control the KARMA function.

If the KARMA function is turned off, press the KARMA ON/OFF switch to make the LED light.

When you play the keyboard or pads, the KARMA function will begin generating a phrase.

2. The control surface's KARMA CONTROLS 1–8 sliders, the KARMA SWITCH 1–8 (lower row), and the SCENE 1–8 switches (upper row) are assigned to control parameters that will vary the generated phrase or pattern in useful ways.

You can press the KARMA SCENE 1–8 switches to change the KARMA SWITCH and KARMA SLIDER settings shown in the LCD screen. In other words, you can move between entirely different settings of all these controls simply by pressing a KARMA SCENE switch.

The KARMA GE page gives you a more detailed picture of the settings. Press the KARMA GE tab to access this page. This page shows the GE (Generated Effect) that's selected for the KARMA module, the time signature for the pattern that's being generated, and the KARMA CONTROLS assignments.

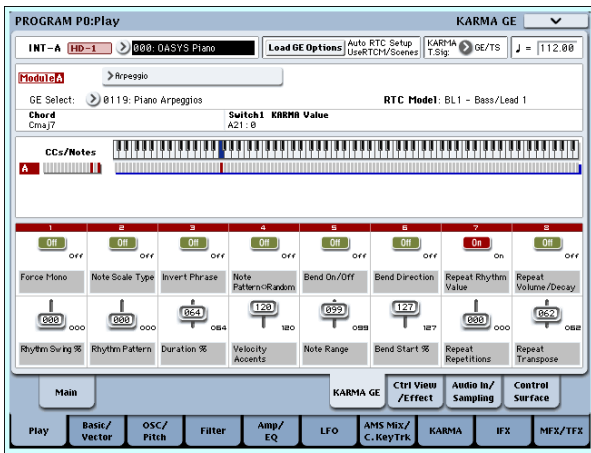

For details on these controllers, see “Performing with KARMA” on page 196.

3. After you’ve edited a load program, you can restore the program to the original state in which it was saved.

Listening to the demo songs

Loading the demo song data in Disk mode

1. Press the MODE DISK switch (the LED will light) to enter Disk mode.
2. Access the Disk– Load page. Press the File tab and then the Load tab.
3. Use “Drive Select” to select HDD.

The contents of the hard disk will appear.

4. Choose the Preload.SNG file.

This file contains demo song data.

PRELOAD.SNG is located in the following directory.

FACTORY → PRELOAD.SNG

Press the Open button to move to a lower directory, and press the Up button to move to the directory above the currently-displayed one.

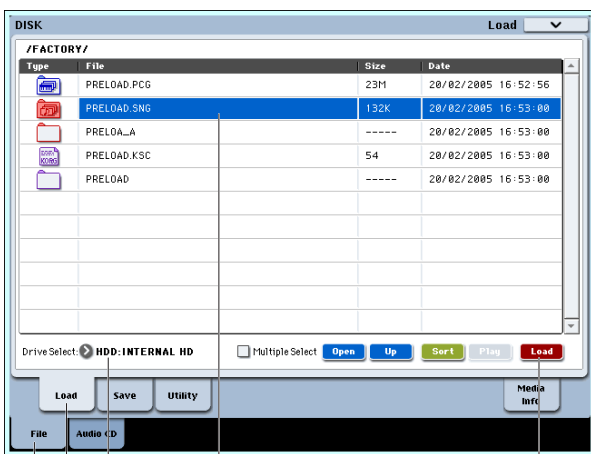

File tab Drive Select PRELOAD.SNG Load button

5. Press the Load button to open the dialog box.

When you press the UTILITY COMPARE switch (the LED will light), the saved settings for that program will be recalled. Press the COMPARE switch once again to return to the edited settings (the LED will go dark).

You can also hold down the UTILITY RESET CONTROLS switch and operate the vector joystick, a control surface slider or knob, or CONTROL ASSIGN switch to recall the saved settings. You can also do the same for KARMA. For more information, see “Resetting controls to their saved values” on page 47.

We hope you enjoyed your quick introduction to the OASYS. There are so many programs and combinations that you probably didn’t actually finish playing them all, so why not take a break from playing, and take some time to listen to the OASYS’ demo songs.

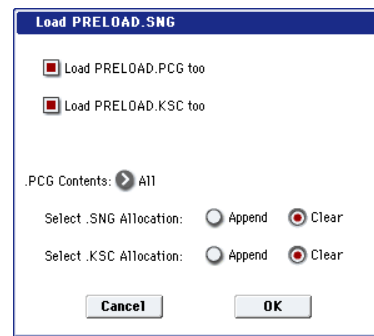

6. Select the “Load PRELOAD.PCG too” and “Load PRELOAD.KSC too” check boxes so that the .PCG file and .KSC file will be loaded along with the .SNG file.

PRELOAD.PCG contains preloaded data for programs, combinations, drum kits, and wave sequences.

PRELOAD.KSC contains sample data for the programs used by the demonstration songs.

Set the “Select .SNG Allocation” and “Select .KSC Allocation” option buttons to Clear. With the Clear setting, all currently loaded RAM multisamples and samples will be erased, and the song data will be loaded in the same configuration as when it was saved. (In contrast, the Append setting will preserve any existing data, and load the songs following the existing data.)

⚠ If you’ve edited any of the above data already, or created new data, executing this Load operation will overwrite and erase this data. If there’s any data you need to keep, save it on the internal hard disk or a USB storage media before you proceed.

7. Press the OK button to execute the Load operation.

Listening to the demo songs in Sequencer mode

1. Press the **MODE SEQ** switch (the LED will light) to enter Sequencer mode.
2. Access the **P0: Play/REC– MIDI Track Prog Select/Mixer** page.

If this page is not displayed, press the **EXIT** switch. Although the exact number will depend on the page you're in, pressing the **EXIT** switch no more than three times will take you to the top page of P0.

Similarly, the songs and demo songs, as well as the user multisamples and samples used by these songs, will disappear when you turn off the power. If you want to use these songs, user multisamples, and samples the next time you turn on the power, you'll need to load them again.

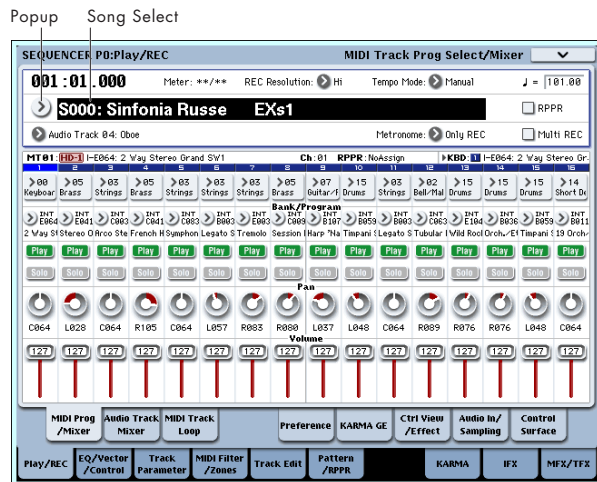

3. Let's start by listening to song **S000**.

Verify that song **S000** is selected. If another song is selected, press the song name display area ("Song Select") to highlight it. Then press the numeric key **0**, and then the **ENTER** switch.

4. Press the **SEQUENCER START/STOP** switch.

The LED will blink, and the song will begin playing back.

5. If you want to stop playback mid-way through the song, press the **START/STOP** switch once again.

6. Let's listen to the next song.

Press the song name display area ("Song Select"). Press numeric key **1**, and then press the **ENTER** switch. (Song "S001" will be selected.)

Alternatively, you can press the round button (Song Select popup) located at the left of the song name, and a list of song names will appear. Select a song, and press the **OK** button.

7. Press the **SEQUENCER START/STOP** switch to begin playback. To stop playback, press the same switch once again.

This completes our quick start.

Of the OASYS' wide range of functionality, this operation guide explains how to use some of the most typical operations. We highly recommend that you take the time to read it completely.

When you've finished working with the OASYS, press the rear panel **POWER** switch to turn off the power.

When you turn off the power, the programs and combinations etc. will revert to the state in which they were before you edited them. If you want to keep your edited settings, you'll need to Write them. For more information, see "Saving your edits" on page 54.

New features in software version 1.2

OASYS software version 1.2 adds a number of new features, including increased polyphony for the AL-1 and STR-1, polyphonic unison, unison stereo spread, improved parameter smoothing, and a powerful and easy-to-use chord feature. It also includes a demo of the new Legacy Analog option, which can be enabled via an authorization code purchased from www.korguser.net.

New EXi option: Legacy Analog

The Legacy Analog collection for OASYS features enhanced versions of two classic Korg analog synths, using Korg's proprietary CMT (Component Modeling Technology): the MS-20EX and PolysixEX.

Much more than simple re-creations of their acclaimed vintage predecessors, however, these EXi take their concepts to the next level—with many new features unique to the OASYS.

Demo mode and authorization

A demo version of the Legacy Analog collection is installed with OASYS software version 1.2, and new Programs using the MS-20EX and PolysixEX are loaded into Bank USER-D.

In demo mode, you can play, edit, and save Programs, Combis, and Songs which use the new EXi—but until you purchase an authorization code, their sound will fade out periodically.

To purchase an authorization code, and to download additional, free banks of Legacy Analog sounds, go to www.korguser.net. Once purchased, you can enter the authorization code on the new Plug-In Info page in Global mode.

For more information, see “Global P6: Plug-in Info” on page 680 of the Parameter Guide.

MS-20EX

The MS-20EX is a flexible, semi-modular virtual analog synthesizer. At its heart is a faithful re-creation of the original Korg MS-20, including both its many features and its distinctive, often aggressive timbral signature.

To this core, we added all of the features first introduced in the Korg Legacy MS-20 plug-in, such as the External Modulation routings, tempo synchronization, and the Analog knob, for modeling the inherent instabilities of analog oscillators and filters.

Then, we made significant, OASYS-only modifications to the Patch Panel, inspired by the MS-20's big brother, the MS-50. These enable discrete access to all major components, including both VCOs, the HPF, LPF, VCA, and the ESP's Band Pass Filter, for more powerful patching capabilities.

The Patch Panel itself is also more flexible, with two new mixers for merging and scaling signals, and unlimited “mults,” so that each output can be connected to multiple inputs. Like the original MS-20, you can also use a live audio input as both an audio and control source.

Finally, we added AMS modulation for all original MS-20 controls, plus four additional EGs, four additional LFOs, and four AMS mixers. Of course, the MS-20EX has access to all standard EXi Program features, including dual key tracking generators, the Common LFO and Common Step Sequencer, Vector, KARMA, EQ, and effects.

For more information, see “EXi: MS-20EX” on page 281 of the Parameter Guide.

PolysixEX

The PolysixEX is a rich-sounding, easy-to-use virtual analog synth. It also features very high polyphony—up to 172 voices, with room for effects!

When designing the PolysixEX, we started with a faithful reproduction of the features and sonic character of the classic Korg Polysix. These include a VCO and sub-oscillator, pulse-width modulation with a dedicated LFO, a four-pole, self-oscillating resonant lowpass filter, an ADSR envelope, a Modulation Generator (aka LFO), an integrated arpeggiator, and built-in effects.

Next, as with the MS-20EX, we added the features from the Korg Legacy Polysix, including External Modulation routings, tempo synchronization, and the Analog control.

Finally, we added AMS modulation for all original Polysix knobs and switches, plus two additional EGs, two additional LFOs, and four AMS mixers.

Of course, the PolysixEX has access to all standard EXi Program features, including dual key tracking generators, the Common LFO and Common Step Sequencer, Vector, KARMA, EQ, and effects.

These additional features open up expressive and timbral possibilities far beyond the original instrument—and yet all of the main synthesis parameters fit onto a single page of the display. Together, these make the PolysixEX a perfect combination of simplicity, great sound, and versatility.

For more information, see “EXi: PolysixEX” on page 307 of the Parameter Guide.

CMT What is CMT?

Korg's CMT (Component Modeling Technology) creates virtual instruments that are indistinguishable from the original. CMT takes an organic approach to modeling, reproducing not only the sound but also the character and response curve of each parameter, so that the results are completely faithful to the original model.

CMT's cloning of the entire instrument, based on an intimate knowledge of the original analog circuits, ensures that every nuance is replicated—delivering all the power and subtlety that up until now only true analog synthesis could provide.

Increased polyphony for the AL-1 & STR-1

As part of our continued refinements to the OASYS system, you can now play more voices of the AL-1 and STR-1!

The updated AL-1 is capable of playing 96 voices (up from 84), and the STR-1's max polyphony is now 48 voices (up from 32—a factor of 50%). Naturally, the full audio fidelity of the previous versions has been preserved.

Unison enhancements

Unison has been improved in several ways, for both HD-1 and EXi Programs. To begin with, you can now enable unison in **Poly** mode, as well as in **Mono**. The new **Unison Stereo Spread** parameter distributes unison voices across the stereo field, for a more intense effect. Finally, the range of **Unison Detune** has been doubled, to a total width of 200 cents (100 cents up and down).

For more information, see “Unison” on page 34 of the Parameter Guide.

Max # of Notes

The new **Max # of Notes** parameter lets you model the voice-leading of vintage synthesizers, such as the Polysix, as well as control the resources required by individual Programs in Combination and Sequencer modes. **Max # of Notes** is available in both HD-1 and EXi Programs, as well as for each Timbre in a Combi and each Track in a Song.

For more information, see “Max # of Notes” on page 33 of the Parameter Guide.

New features in software version 1.1

OASYS software version 1.1 added a number of new features, including the STR-1 Plucked String EXi, support for up to 2GB of RAM, a new AMS Mixer type, and more.

New EXi: STR-1 Plucked String

As the first EXi update for OASYS, the STR-1 Plucked String advances the state of the art in physical modeling, building on over a decade of Korg's research with new innovations exclusive to OASYS. It offers a comprehensive and sophisticated set of synthesis tools, capable of creating both traditional sounds (acoustic and electric guitars and basses, clavichords and harpsichords, harps, bells, electric pianos, ethnic instruments, etc.) and unique, experimental timbres.

For more information, see “EXi: STR-1 Plucked String” on page 235 of the Parameter Guide.

Improved parameter smoothing

Since its initial release, OASYS has used several different smoothing processes to minimize “steppiness” on knobs, sliders, and controls. These processes have been further improved, via a new adaptive smoothing algorithm.

Tone Adjust is now smoothed as well, so that you can use this Control Surface mode for performance as well as editing. Many parameters are also now smoothed even when edited from the LCD.

Chord mode

The original Polysix had a fun, cool Chord function, which let you store a chord and then transpose it by playing single notes on the keyboard. We thought this was such a good idea that we integrated it throughout the OASYS system. You can now enable Chord mode for any HD-1 or EXi Program, as well as for each Timbre in a Combi and each Track in a Song.

Chord mode is integrated with the Drum/Chord Pads. Just as before, you can store up to 8-note chords for each Pad—but now, with Chord mode, you can use the pads to select a chord, and then play it from the keyboard.

A new Chord SW function lets you enable and disable Chord mode from SW1, SW2, or the Assignable Foot Switch.

Chord mode can duplicate the way that the Polysix chords worked, but it can also use all of the Voice Assign options to create different effects—such as mono legato chords with fingered portamento, or poly chords that overlap one another.

For more information, see “Using Chord mode” on page 49, and “Chord” on page 34 of the Parameter Guide.

Support for up to 2 GB of RAM

OASYS now supports up to 2 gigabytes of RAM, which can be used for RAM and EXs samples. Among other things, this means that you may now load both EXs1 and EXs2 at the same time, if desired.

For more information, see “Installing memory” on page 1038 of the Parameter Guide, “Expansion Sample Setup” on page 684, and “Sampling and RAM” on page 563 of the Parameter Guide.

Supported DRAM DIMM modules

The OASYS has two DIMM sockets. One slot is occupied by factory-installed memory; the other is left open for user expansion.

⚠ Some commercially-available memory will not work with the OASYS. The following types of memory are supported.

Specifications: 184-pin DIMM DDR SDRAM, unbuffered, non-ECC

PC2700 (DDR333 CL2.5)

PC3200 (DDR400 CL3)

Capacity for the additional DIMM: 512MB or 1GB

 DRAM DIMM is not a manufacturer option. Please use commercially-available memory sold for computers.

If you have any questions regarding the type of DRAM DIMM modules that can be used, please contact your local Korg distributor.

EXi audio input

OASYS now includes standard parameters for routing audio into EXi instruments. You can use this for processing live or recorded inputs through EXi synthesis engines, or for creating feedback loops.

Initially, these features are supported by the new STR-1. For more information, see “4-2: EXi Audio Input” on page 162 of the Parameter Guide (Program mode), “2-6: EXi Audio Input” on page 367 of the Parameter Guide (Combination mode), and “2-6: EXi Audio Input” on page 475 of the Parameter Guide (Sequencer mode).

For information on using audio input with the STR-1, see “4-8c: Feedback” on page 257 of the Parameter Guide.

New AMS Mixer type: Gate

This new Mixer Type lets you set up two different AMS sources (or fixed AMS amounts), and then switch between the two using a third AMS source.

It’s similar to an audio gate with a side-chain, but with even more flexibility—since you get to choose what happens when the gate is closed (below the threshold), as well as when it’s open (above the threshold).

Among other things, you can use this to apply pitch bend to some notes, but not to others, based on the state of a controller at note-on.



For more information, see “Gate” on page 93 of the Parameter Guide.

Half-Damper Enable

In the previous OASYS software, Half-Damper pedals, normal sustain pedals, and MIDI CC#64 modulated the Amp EG Release Time by default. This feature may now be enabled or disabled as desired, on a per-Program basis.

For more information, see “1-1f: Half-Damper Control” on page 36 of the Parameter Guide (HD-1 Programs) and “4-1g: Half-Damper Control” on page 161 of the Parameter Guide (EXi Programs).

Footswitch can control Inc/Dec

You can now assign the foot-switch to control the front-panel Inc  or Dec  buttons. This can be convenient in certain live performance situations. For more information, see “Using a footswitch to select Programs” on page 45, and “Foot Switch Assignments” on page 981 of the Parameter Guide.

Introduction to OASYS

Main Features

Open Architecture Synthesis Studio

The OASYS features the OA (Open Architecture) synthesis system, which offers all the benefits of a variable software system backed by the hardware integrity that can only come from a fully-integrated instrument design.

Currently, the OASYS includes sophisticated PCM sample playback including Wave Sequencing and Vector Synthesis (the HD-1 High Definition Synthesizer), analog modeling (the AL-1 Analog Modeling Synthesizer), tonewheel organ modeling (CX-3 Tonewheel Organ), and physical modeling (the STR-1 Plucked String).

The optional LAC-1 Legacy Analog Collection adds two CMT Modeled Analog Synthesizers, the MS-20EX and PolysixEX, for a wealth of additional timbral capabilities.

The OASYS's Open Architecture is designed to enable future options to further expand the instrument's capabilities, including additional EX*i* expansion instruments, EXs expansion samples, and EXf expansion effects.

The OA (Open Architecture) synthesis system together with KARMA, a sixteen track MIDI sequencer and sixteen track hard disk recorder, a sampler, control surface, and a keyboard with great response are all tied together by a high-speed processor into an organic whole as the OASYS (Open Architecture Synthesis Studio), the perfect instrument to fuel your musical creativity.

Detailed Specifications

- Synthesis methods:
 - HD-1 High Definition Synthesizer
 - AL-1 (Analog Modeling Synthesizer)
 - CX-3 (Tonewheel Organ)
 - STR-1 (Plucked String)
 - MS-20EX (CMT Modeled Analog Synthesizer)
 - PolysixEX (CMT Modeled Analog Synthesizer)
 - Future EX*i* (Expansion Instruments)
- Maximum polyphony ^{*1} ^{*2}:
 - HD-1: 172 voices (172 oscillators)
 - AL-1: 96 voices
 - CX-3: 172 voices
 - STR-1: 48 voices
 - MS-20EX: 48 voices
 - PolysixEX: 172 voices
- PCM sampling method: 16-bit, 48 kHz uncompressed
- Preset PCM: 314 MB (1,505 multisamples, 1,338 drum samples)

- EXs1 ROM Expansion: 313 MB (229 multisamples, 1,483 drum samples)
- EXs2 Concert Grand Piano: 503 MB (10 multisamples)
- PCM RAM: Up to about 1.5GB, depending upon the installed RAM and currently loaded EXs samples; see "Sampling and RAM" on page 119 for more information.
- Wave sequences: 374 user memories, 150 preloaded

*1) The actual maximum polyphony depends on the oscillator settings for stereo multisamples, velocity crossfading, wave sequence crossfading, and double mode.

*2) If multiple synthesis methods are being used simultaneously, the required number of voices of polyphony will automatically be allocated by the system as necessary.

PCM synthesis engine – HD-1 High Definition Synthesizer

High-capacity PCM sounds, newly designed oscillator

The HD-1 High Definition synthesizer, which is the PCM synthesis engine of the OASYS, uses a newly designed oscillator.

The PCM waveforms are 16-bit 48 kHz uncompressed data. They include a total of more than 1 Gigabyte of meticulously-recorded stereo samples and long samples.

Each voice has oscillators (two oscillators allowing four-stage velocity switching/crossfading/layering) that can use up to eight (stereo) multisamples, up to four filters (two filters each with four modes and four routings), two amps, five LFOs, and five EGs, all available simultaneously.

Each voice (oscillator, filter, amp, etc.) provides a generous array of modulation functions and parameters, letting you construct intricate and rich sounds.

The EXs2 Concert Grand Piano extended PCM library consists of a lavish 503 MB of long stereo samples, captured for each key at four levels of dynamics. In addition, the Note-On Control function reproduces the sympathetic string vibration that occurs when you hold down the damper pedal. When you hold down the damper pedal and strike a key, the sympathetically vibrating strings will also sound, faithfully replicating the depth and transparency of an acoustic piano.

Staple ensemble sounds such as strings and brass use stereo sampling to capture their natural spaciousness, with a rich variety of articulations such as tremolo,

pizzicato, and sforzando, as well as four-level velocity switching and crossfading to ensure a natural range of expression.

Reed instruments such as sax and oboe were sampled for extended times to include natural-sounding vibrato produced by the player.

The drums that are so important for the overall character of a track also use stereo sampling, with long samples that capture the natural decay and four-level velocity switching and crossfading for natural dynamics.

Wave sequencing – generating textured tones or rhythmic sounds

In addition to simply playing back the PCM waveform, the HD-1 High Definition Synthesizer's oscillators also support Korg's proprietary Wave Sequencing functionality.

Wave sequencing successively switches through PCM waveforms, crossfading between different sounds to create textured tones or rhythmic sound designs. Made famous on Korg's WAVESTATION, wave sequencing has been redesigned to be even easier and more creative than ever.

You don't have to stop with simply playing back PCM waveforms in succession – you can freely specify the timing, length, and pitch of each waveform. The timing at which waveforms are switched can even be synchronized to the tempo. You can also use AMS (Alternate Modulation Sources) to obtain sound design possibilities that are completely unthinkable for a conventional PCM synthesizer; for example, you can use the output of an envelope generator to control the timing at which waveforms are switched.

Advanced Vector Synthesis – create not only sounds, but also sound fields

The OASYS includes Advanced Vector Synthesis, which lets you synthesize spatial sound-fields.

In Combination mode, you can assign each timbre to one of the four directions (up, down, left, or right), and use the front-panel Vector Joystick to control the timbre volumes or effects.

In Program mode, you can use this for realtime control over the balance between oscillators 1 and 2 or for controlling effects, giving you a powerful tool to create sounds with dynamic movement.

In addition to controlling the Vector position manually in realtime, you can use the five-point Vector Envelope to control vectors automatically. For each point, you can specify the Vector position, how long the envelope will hold at the point, and how long it will take to transition to the next point. Transition and hold times can use either absolute time, or rhythmic values synchronized to the system tempo.

Ultra high-precision filters are the core of sound design

Because of its power and conceptual ease of understanding, subtractive synthesis (the technique of creating sound by selectively removing portions from

an overtone-rich waveform) has become the standard for synthesizers today. One of the most important components of subtractive synthesis is the filter.

The filter section of the HD-1 High Definition synthesizer provides four filtering types (low pass, high pass, band pass, and band reject) and four types of routing (single, serial, parallel, and 24 dB).

The amazing power of the OA (Open Architecture) synthesis system produces natural and beautiful filtering that does not weaken the sound, delivering smooth filter sweeps and resonance.

The amp of the OASYS contains driver circuitry that covers a wide range of distortion, from the mild and warm overdrive characteristic of classic analog synthesizers, to the sharp distortion produced by audio signal feedback.

In addition, the key tracking generator allows the filtering to vary according to the keyboard range; you can apply subtle filtering for convincing simulation sounds, or aggressive filtering that produces drastic changes in filtering as you play up or down the keyboard.

Dive into an ocean of creative potential – flexible modulation routing, EG, LFO, and AMS

OASYS takes advantage of its lavish amount of available processing power to produce ultra-fast and ultra-smooth EGs (envelope generators) and LFOs.

EGs allow you to specify how the sound develops over time, from its onset to its end. The HD-1 High Definition Synthesizer lets you adjust the curvature of each EG stage (attack, decay, slope, and release), giving you detailed control over how the tone and volume change over time, and making it possible to program anything from simulated acoustic sounds to vintage synthesizer sounds in the utmost detail.

The HD-1 provides a common LFO for each timbre and two LFOs for each voice. You can choose from eighteen types of LFO waveform, and also adjust the phase of the waveform, the curve, and the center value of the amplitude to create distinctively modulated sounds that have never been heard before. Since the waveform itself is generated with extremely high precision, you can create perfectly smooth sweeps. You'll appreciate the LFO's tightness and accuracy not just at high speeds, but also for low-speed modulation. It goes without saying that you can also apply key sync so that the same modulation occurs each time a note is played, or synchronize the modulation speed to the tempo to create rhythmical tonal changes.

Korg's AMS (Alternate Modulation Sources) give you a rich array of modulation possibilities, with 52 different modulation sources you can use to control the sound in complex ways. The OASYS takes this classic Korg feature even further, via the AMS Mixers. These let you create even more detailed modulation designs, such as mixing two modulation sources together, multiplying one modulation source by another, or modifying the shape of the modulation source in various ways.

Detailed Specifications

- Advanced Vector Synthesis: Use the vector joystick and vector envelope (tempo synchronization

available) to control the oscillator volume, synth parameters, or effect parameters.

- Single/double structure: Single=OSC1 only, Double=OSC1 and OSC2
- Oscillator: To each oscillator you can assign a multisample or wave sequence with four-level velocity-switching, crossfading, or layering.
- Filter: Two multi-mode filters for each voice (low pass, high pass, band pass, band reject), with four filter routings (single, serial, parallel, 24 dB)
- Driver: One non-linear driver/low boost for each voice
- EQ: Three-band EQ for each voice (mid-sweepable)
- Modulation: For each voice, two envelope generators (Filter and Amp), two LFOs, two key tracking generators (Filter and Amp), and two AMS mixers
- Other: Pitch EG, common LFO, two common key tracking generators

An effects section with up to sixteen effects available simultaneously

The OASYS provides twelve insert effects, two master effects, and two total effects, all available simultaneously, and all providing stereo input and output. There's also a Common LFO that can be shared by these effects, for example to synchronize the modulation of separate types of effect such as phaser and chorus.

The three-band EQ provided on each timbre lets you make tonal adjustments without using up effect processing power. In Sequencer mode, three-band EQ is provided on a total of 32 tracks (MIDI + audio), giving you detailed tonal control over each track.

Eight types of chorus (including four-stage and eight-stage types), high-resolution reverb that models even the shape and material of the wall surfaces, startlingly realistic modeling effects (such as guitar/bass amps) using Korg's proprietary "REMS"* modeling technology, and mastering effects are all provided, giving you a total of 185 types of high-quality effect that can be used as insert effects, master effects, or total effects, and applied to individual timbres, to an entire ensemble, or to your completed song.

These effects can be configured easily and efficiently using the OASYS' powerful mixer that gives you complete routing flexibility.

You can also apply effects while sampling or during hard disk recording.

What is REMS *REMS** ?

REMS (Resonant structure and Electronic circuit Modeling System) is Korg's proprietary technology for digitally recreating the numerous factors that produce and influence a sound, ranging from the sound-production mechanisms of acoustic instruments and electric/electronic musical instruments, to the resonances of an instrument body or speaker cabinet, the sound field in which the instrument is played, the

propagation route of the sound, the electrical and acoustic response of mics and speakers, and the changes produced by vacuum tubes and transistors.

Detailed Specifications

- Insert effects: 12 processors, stereo in/out
- Master effects: 2 processors, stereo in/out
- Total effects: 2 processors, stereo in/out
- Timbre EQ: Three-band EQ for each timbre
- Effect types: 185 (every effect type is available for Insert, Master, or Total effect processors)
- Modulation: Dynamic Modulation, Common LFO
- Effect control bus: Stereo side chain (compressor, gate, vocoder, etc.)
- Rec bus: two stereo buses (routing settings for recording and sampling)

Programs, combinations and drumkits

The carefully constructed programs and combinations take full advantage of the OASYS' synthesis engine, KARMA function, control surface, vector joystick, and other controllers.

The drum programs utilize long stereo samples to ensure natural decays, especially for cymbals. Velocity crossfading allows seamless changes in playing dynamics, giving you a full range of expression from delicate to dynamic. Drum kits are used by assigning them as the oscillator for a program.

Programs/combinations/drumkits:

- 1,664 user memory programs (904: 640 HD-1 + 256 EXi + 8 EXs2 preloaded)
- 1,792 user memory combinations (384 preloaded)
- 152 user memory drumkits (40 preloaded)
- 256 GM2 preset programs + 9 GM2 drum preset programs

Detailed Specifications: Programs

See:

- "PCM synthesis engine – HD-1 High Definition Synthesizer" on page 9
- "AL-1 Analog Modeling Synthesizer" on page 13
- "CX-3 Tonewheel Organ" on page 14
- "STR-1 Plucked String" on page 15
- "MS-20EX" on page 15
- "STR-1 Plucked String" on page 15

Detailed Specifications: Combinations

- Timbres: 16 timbres, with keyboard and velocity splits, layers, and crossfades
- Master keyboard functionality: control external MIDI devices
- Tone Adjust: adjust the sound of each timbre's Program
- Advanced Vector Synthesis: Use the vector joystick or vector envelope (tempo synchronization available) to control each oscillator's volume, synth parameters, and effect parameters

Detailed Specifications: Drumkits

- Stereo or mono drum samples
- Four-level velocity switches or crossfades

KARMA

The OASYS' KARMA (Kay Algorithmic Music Architecture) function is an enhanced version of the Korg KARMA Music Workstation. Based on the notes and chords you play, KARMA instantly generates phrases and patterns of MIDI data, and you can create highly sophisticated musical changes simply by operating the KARMA realtime controls.

KARMA is an algorithmic MIDI data generation technology that does not simply generate MIDI data in a one-sided manner; it changes its own internal settings according to the notes and chord forms that you play, and responds to the input from the KARMA realtime controls to automatically vary the musical data it generates. This lets KARMA contribute to your musical creativity in an enormously powerful way.

The heart of KARMA consists of GEs (Generated Effects) and KARMA modules. A GE is an algorithm that takes the notes and chords you play, and generates phrases, patterns, and tonal changes in response. The OASYS provides a generous assortment of 2,048 preset GEs. The vast number of GEs are organized into 12 categories according to their purpose, for quick and easy selection.

In Program mode you can use one KARMA module, and in Combination and Sequencer modes you can use up to four KARMA modules. You can store up to eight "scenes" – sets of parameter settings that determine how the KARMA modules generate performance data – and switch between them as desired. Additionally, you can use the control surface of the panel to control the KARMA function in realtime. Virtually infinite performance possibilities are at your fingertips.

Module Control functionality lets you control each KARMA module separately or together. The new RTC model automatically sets-up typical realtime control parameter settings for each GE, provides a revolutionary leap of efficiency in setting up a song.

Note Map Tables let you obtain a rich palette of variations from even a single GE. The Scene Matrix function gives you centralized management of the eight scenes maintained by each KARMA module. The new KARMA Wave Sequence functionality uses KARMA to switch between multisamples of a PCM oscillator.

The KARMA function on the OASYS has been reborn to a completely new level of power, functioning as a supplementary musical brain that will assist you in everything from production to performance.

Detailed Specifications

- KARMA modules: 1 module in Program mode, 4 modules in Combination and Sequencer modes
- GEs (Generated Effects): 2,048 presets
- Controllers: ON/OFF, LATCH, CHORD ASSIGN, MODULE CONTROL, KARMA REALTIME CONTROL SLIDERS 1–8, KARMA SCENES 1–8,

KARMA SWITCHES 1–8, Auto RTC (Real Time Control) Setup function

Open Sampling System

Mono/stereo sampling

The OASYS provides high-quality 16-bit linear 48 kHz mono/stereo sampling functionality. Samples can be either recorded into RAM memory or written directly to the internal hard disk as WAVE files.

The amount of RAM available for sampling depends upon the currently loaded EXs samples, as described under "Sampling and RAM" on page 119. When there is 500MB of RAM available, for instance, you can sample up to approximately 91 minutes (monaural) or 45 minutes 30 seconds (stereo).

When sampling to the internal hard disk, a single sample file can be up to 80 minutes long for either monaural or stereo. Samples recorded to the hard disk can be loaded into RAM memory and used as tone generator waveforms.

You can load sample files in AIFF, WAVE, AKAI S1000/ 3000, or Korg formats; all will be handled as Korg format data once they are loaded. You can also export sample data as AIFF or WAVE files. You can use the internal CD-R/RW drive or a USB CD-ROM or CD-R/RW drive to rip audio data in the digital domain from an audio CD. Alternatively, you can capture the playback of an audio CD from the AUDIO INPUT jacks.

Open Sampling System – take advantage of each mode's functionality while sampling

The OASYS lets you sample or resample not just in Sampling mode, but also in Program, Combination, and Sequencer modes. In Sequencer mode, the In-Track Sampling function lets you sample an external audio input source while the song plays, and will automatically create a note event at the appropriate point in the track to play back this sample at the right time. In Program or Combination modes, you can resample complex sounds and performances utilizing functions such as wave sequencing, advanced vector synthesis, and the KARMA function. In Sequencer mode, you can resample the playback of the song itself, and use this capability to create portions of a song that you can layer into complex compositions or use as tone generator waveforms.

Sample editing functionality that rivals dedicated units

The full range of sample editing operations include Truncate, Normalize, Cut, Copy, and Reverse, and even advanced functionality such as Time Slice and Time Stretch. The grid display and waveform zoom functions are a great convenience when you need to make precise edits to a waveform. The OASYS provides not only a great set of editing operations, but also features that make sample editing easy and efficient, such as a Use Zero function to automatically detect zero-crossing points that won't produce noise.

Detailed Specifications

- Open Sampling System, with resampling and In-Track sampling
- 16-bit/48 kHz stereo/mono sampling
- Up to about 1.5GB of PCM RAM, depending upon the installed RAM and currently loaded EXs samples; see “Sampling and RAM” on page 119 for more information
- Maximum of 4,000 samples/1,000 multisamples (up to 128 indexes per multisample)
- Direct sampling from CD (CD-DA)
- Load AKAI S1000/S3000 data, as well as Korg, AIFF, and WAVE formats

EXi expansion instruments

EXi expansion instruments allow you to expand the synthesis capabilities of the OASYS. Some are enabled from the factory, including the AL-1 Analog Modeling Synth, the CX-3 Tonewheel Organ, and the STR-1 Plucked String. Others are optional, including the MS-20EX and PolysixEX.

EXi Programs let you use any two EXi together, and provide a number of common features, as detailed below.

Detailed Specifications

In addition to individual EXi features, all EXi Programs include:

- Advanced Vector Synthesis: Use the vector joystick and the vector envelope (tempo synchronization available) to control each oscillator’s volume, synth parameters, and effect parameters
- Modulation: Common step sequencer, AMS (Alternate Modulation Source), common LFO, two key tracking generators
- Three-band EQ (adjustable mid-frequency)

AL-1 Analog Modeling Synthesizer

The first OASYS EXi Expansion Instrument is a state-of-the-art virtual analog synth engine: the AL-1. Not content with a mere handful of modeled voices, the AL-1 delivers an unparalleled 96 notes of polyphony, capable of sounding an incredible 576 oscillators (including dual sawtooths and noise generators).

Ultra-low aliasing oscillators

This responsive synth features our distinctive ultra-low aliasing oscillators that recreate all the power and glory of true analog synthesis – without the artifacts that can often plague lesser modeled oscillators. But that’s just the beginning.

The AL-1 will satisfy all your vintage yearnings - and your future ones as well. The two main oscillators offer eight flexible waveforms each, for a wide palette of modulatable shapes. Other progressive features include wave-shape morphing, a floor-thumping sub-oscillator plus a variable-color noise generator capable of white, pink, red flavors - and beyond.

An adjustable drive parameter provides a distinctive character to the vintage oscillator modeling; while sync, FM, low-boost and several varieties of ring modulation offer plenty of tone-mangling power. External live audio can even be accessed as an additional signal source.

Dual multi-mode resonant filters

Each voice can use either one or two of Korg’s incredibly versatile multimode (Low Pass, Band Pass, Band Reject [notch], and High Pass) resonant filters. For maximum flexibility, the filters can be connected in series or parallel, to generate 12 dB or 24 dB per octave slopes.

Korg’s new MultiFilter lets you crossfade in real time between any two of 21 different filter types – including your own custom mixes of LP, HP, BP, BR and dry input.

Powerful, solid sounds from the Drive and Low Boost circuits

Classic vintage analog synthesizers derived some of their character from distortion that occurred in each stage of their components. The AL-1 features a Drive circuit that replicates these classic sounds. You can also use the drive circuit more aggressively to create punchy overdriven sounds. There’s also a Low Boost circuit that lets you control the low-frequency character of the sound.

High-quality, high-precision, high-function LFOs

The AL-1 provides a common LFO for each timbre and four LFOs for each voice. If you’re using the maximum polyphony, this means that an amazing 385 LFOs* are operating simultaneously.

You can choose from eighteen types of LFO waveform, and also adjust the phase of the waveform, the curve, and the center value of the amplitude to create a wide variety of distinctive modulation. Since the waveform itself is generated with extremely high precision, you can create perfectly smooth sweeps. You’ll appreciate the LFO’s tightness and accuracy not just at high speeds, but also for low-speed modulation.

It goes without saying that you can also apply key sync so that the same modulation occurs each time a note is played, or synchronize the modulation speed to the tempo to create rhythmical tonal changes.

Ultra-fast ultra-precise envelope generators

The AL-1 provides an ultra-fast ultra-precise envelope generator (EG). As with the EGs of the PCM synthesis engine, you can adjust the curve for each stage (attack, decay, slope, and release), and take advantage of sophisticated modulation features that go well beyond conventional EGs, such as the EG Reset feature that lets you retrigger the EG any number of times between note-on and note-off.

Step Sequencer

The step sequencer built into the AL-1 can not only play phrases or rhythms, but also be used as an extremely sophisticated modulation source. If the output of the step sequencer is assigned to Pitch, the

result will be a melodic phrase. If assigned to the filter, the filter will produce modulation in synchronization with the tempo.

The step sequencer also provides a “Smoothing” parameter that interpolates between the values of each step, letting you create not just step-wise modulation but also smooth change that can function as an LFO with freely-specified waveform. Since you can specify the duration of each step individually, this can be used to create not just simple beats but also complex rhythms, producing a mind-boggling universe of phrases, rhythms, and modulation.

AMS – a powerful modulation system with AMS Mixers and Keyboard Tracking Generators

The AL-1 gives you a modulation system that is far more powerful than any other, with AMS (Alternate Modulation Source) at its core. You can choose from an amazing 52 different modulation sources, including the output of the step sequencer, EGs, and LFOs, as well as controllers such as the joystick, knobs, pedals, and switches. These sources can be assigned to modulation destinations such as sound parameters like pitch or cutoff, and can also be used to modulate the EG attack time or sustain level. You can even create a highly complex modulation source by using one modulation source to modulate another modulation source; for example, using an EG to modulate the waveform of an LFO.

There are also two Key Tracking generators that let you create natural changes – or dramatic transformations – in parameter values as you play different ranges of the keyboard.

In addition, the newly developed AMS Mixers not only lets you mix multiple modulation sources and assign them to a single modulation destination, but also let you modify the source itself so that a single modulation source can be adapted to multiple uses.

Detailed Specifications

- Oscillators: OSC1, OSC2, Sub OSC, noise generator, ring modulator, FM
- Audio input: External audio sources can be processed by ring modulation, filtering, driver, amp, or EQ
- Filter: Two multi-mode filters per voice (low-pass, high-pass, band-pass, band reject), four filter routings (single, serial, parallel, 24 dB)
- Multi-filter (filter A only: low-pass, high-pass, band-pass, and direct input can be mixed freely)
- Driver: Per-voice non-linear driver/low-boost
- Modulation: Five envelope generators, four LFOs, two key tracking generators, two AMS mixers, one step sequencer– in addition to the Common LFO, Common Step Sequencer, Common Key Tracking generators, and Vector EG of the EX_i Program

CX-3 Tonewheel Organ

A perfect simulation of a tonewheel organ system

Tonewheel organs generate sound by rotating toothed metal disks (the tonewheels) past a pickup to generate sine waves. Korg’s CX-3 uses cutting-edge modeling technology to precisely replicate the distinctive modulation and noise components of sounds produced in this way, and this technology has been further refined and included in the OASYS as the CX-3. Two tonewheel types are provided; “Vintage” which models even the leakage noise from the tonewheels, and “Clean” which faithfully reproduces the warm tonewheel organ sound. In addition, the noises produced by the tonewheel and the vacuum tube amp, and even the operation of the wheel brake, have all been simulated to an obsessive degree of perfection. Just like real tonewheel organs, the CX-3 delivers full-key polyphony*, letting you enjoy the same playing feel as on a vintage organ.

* The maximum polyphony will vary depending on how the insert effects are being used. (The polyphony is 172 voices if no insert effects are used.)

Drawbars – the heart of a tonewheel organ

A drawbar organ allows the player to create the desired sound by pulling out drawbars that are assigned to various pitches relative to the fundamental, and this capability is provided on the CX-3 Tonewheel Organ by the Tone Adjust function which you can control using the nine sliders on the front panel. You can also use the Tone Adjust function to switch the rotary speaker between slow/fast and control the percussion and wheel brake from front panel knobs and switches that you’ve assigned to these functions, enjoying the immediacy of dynamic control that’s so important for an organ performance.

EX mode for new sound-creating potential

In addition to modeling a standard tone-wheel organ with 9 drawbars and single-pitch percussion, the CX-3 adds Korg’s exclusive EX mode. This adds four additional drawbars, with pitches adjustable in half-step increments between 16’ and two octaves above 1’. EX mode also allows you to create custom percussion using up to five different pitches, each with adjustable volume levels. Together, the additional drawbars and custom percussion open up even deeper possibilities for creating new sounds.

Realistic simulation of rotary speaker effects

The CX-3 not only provides an impeccable tonewheel simulation, but also gives you everything you need to complete the sonic experience, with effects such as amp modeling, vibrato/chorus, and rotary speaker. You can choose from three different characters of amp modeling, and a vibrato/chorus effect that provides presets as well as being customizable. For the rotary speaker that is so indispensable to organ sounds, you can separately specify the rotational speed of the horn and rotor, and even make detailed adjustments to parameters such as the rate at which the rotation changes from slow to fast. In addition, the rotary speaker includes two stereo mic simulators that let you specify the distance from the speaker to the mic and

the distance between mics. This gives you total control over the sound field as well as the sound itself, and lets you create the perfect organ sound for any situation. Since an effect that is completely compatible with this rotary speaker effect is also provided in the effect section of the OASYS itself, you can enjoy a powerful rotary speaker sound even when you've created a combination using several instances of the CX-3, or with other instruments such as the HD-1 or AL-1.

Detailed Specifications

- Tonewheel Organ Model, with Clean/Vintage mode, percussion, key click, wheel brake
- EX mode: Four drawbars with adjustable frequency ratio, and four percussion drawbars
- Internal effects: Rotary speaker, vibrato/chorus, amp modeling, three-band EQ
- Drawbar control: The nine front-panel sliders on the front panel can be used to control the drawbars, via Tone Adjust
- Split: different drawbar settings for virtual upper and lower manuals. Split is available even in EX mode.
- Modulation: Two AMS mixers

STR-1 Plucked String

Multifaceted physical modeling

The STR-1 Plucked String offers a comprehensive and sophisticated set of physical modeling synthesis tools, capable of creating both traditional sounds (acoustic and electric guitars and basses, clavichords and harpsichords, harps, bells, electric pianos, ethnic instruments, etc.) and unique, experimental timbres.

Building on over a decade of Korg's research, the STR-1 advances the state of the art with a number of new innovations exclusive to OASYS.

Detailed Specifications

- Physically modeled string, including damping, decay, dispersion, nonlinearity, and harmonics
- String excitation via a selection of "pluck" types, a noise generator with saturation and dedicated filter, and any ROM, EXs, or RAM samples (using Korg's ultra-low-aliasing PCM oscillator, as first introduced in the HD-1)
- Dual multi-mode resonant filters (including Korg's Multi Filter, as first introduced in the AL-1), plus an additional multi-mode resonant filter dedicated to the string excitation
- Live audio input, including modeled feedback
- Four per-voice LFOs, five re-triggerable EGs, two key tracking generators, a string tracking generator, and four AMS mixers

MS-20EX

Semi-modular synth with a distinctive tone

The MS-20EX is a flexible, semi-modular virtual analog synthesizer, developed using Korg's proprietary CMT (Component Modeling Technology). At its heart is a

faithful re-creation of the original KORG MS-20, including both its features and its distinctive, often aggressive timbral signature.

To this core, we added features first introduced in the KORG Legacy MS-20 plug-in. Then, we added significant patch-panel modifications inspired by the MS-20's big brother, the MS-50, plus many other OASYS-only enhancements.

For more information, see "MS-20EX" on page 6, and "EXi: MS-20EX" on page 281 of the Parameter Guide.

Detailed Specifications

- Two oscillators (including ring modulation), noise generator, and resonant, self-oscillating highpass and lowpass filters
- Modifications to the Patch Panel, for separate access to individual VCOs, VCFs, and the VCA
- Two patchable 2-in, 1-out audio-rate mixers, for combining and scaling either audio or control signals
- Original MS-20 HADSR and DAR envelopes, plus four additional multi-stage EGs
- Original MS-20 MG and sample-and-hold, plus four additional LFOs
- AMS modulation of all original MS-20 parameters, along with four AMS Mixers
- Live audio input
- External Signal Processor, with dedicated highpass and lowpass filters, triggering, and audio-to-CV conversion (can be used as extra filters for complex patches, as well as for processing audio inputs)

PolysixEX

Rich sounding, versatile, and easy-to-use synth

The PolysixEX is a rich-sounding, easy-to-use, high-polyphony virtual analog synth (up to 172 voices!). Developed using Korg's proprietary CMT (Component Modeling Technology), it combines the features and sonic character of the classic KORG Polysix (and the Legacy Polysix plug-in) with many additional features unique to the OASYS:

For more information, see "PolysixEX" on page 6, and "EXi: PolysixEX" on page 307 of the Parameter Guide.

Detailed Specifications

- Oscillator, sub-oscillator, and 4-pole resonant lowpass filter
- Dedicated chorus/ensemble/phaser effects
- Classic ADSR envelope, plus two multi-stage EGs
- Classic "MG" LFO, plus two multi-waveform LFOs
- Easy-to-use, sample-accurate arpeggiator
- Extensive AMS modulation, plus four AMS mixers

A new leap to the ideal workstation – a 16-track MIDI sequencer plus a 16-track hard disk recorder

The sequencer of the OASYS provides plenty of capacity, with a maximum of 200 songs and 400,000 MIDI events or 300,000 audio events. It consists of a 16-track MIDI sequencer and 16-track hard disk recorder, giving you a total of 32 tracks. In addition to realtime recording and step input, the MIDI sequencer is also able to record phrases generated by the KARMA function, the internal rhythm patterns, and RPPR (Realtime Pattern Play/Recording) function, letting you create sequence tracks quickly and easily. After you've recorded your performance, you can easily perform detailed event editing. There's also a Template Song function that's convenient when you're ready to start creating MIDI tracks. Simply select a template that contains the instruments and effects appropriate for the style of song you want to create, and start recording immediately. The Tone Adjust function lets you make temporary adjustments to the sound of the program used by each track, so you can stay in Sequence mode while creating your song, and make adjustments as desired – for example by softening the tone of the bass or speeding-up the attack of a string sound. You can also make the sound change in realtime during a song by recording and playing back MIDI system exclusive messages. The OASYS provides a seamless environment that unifies MIDI and audio-based song production, with audio-related functions such as Time Slice and the In-Track Sampling function that lets you sample an external audio source that's playing along with your song (sequence data) and automatically place the appropriate note data in a track to trigger the sample. With this type of highly integrated environment, you'll be able to produce high-quality songs in an amazingly short time. You can use the control surface for intuitive and smooth control.

The 16-track hard disk recorder records 16-bit uncompressed 48 kHz audio data. Not simply an audio recorder, it also provides automation functionality as well as editing capabilities that are just as sophisticated and detailed as provided for the MIDI track sequencer, offering commands such as Copy, Paste, Fade, Normalize, Time Stretch/Compress, and Audio Event Editing. The OASYS provides everything you need for any situation – from songwriting to full-fledged recording.

The effect section lets you use up to sixteen effects simultaneously, providing twelve Insert Effects that can be applied independently to each track, two Master Effects that can be applied to sends 1/2, and two Total Effects that can be applied to the final stage of playback for all tracks to add a finishing touch to your sound. You can choose from 185 types of effect that cover every need. These effect types range from effects ideal for recording, such as a guitar amp model + cabinet, bass amp model + cabinet, and mic modeling + preamp, through effects used for mastering, such as a stereo mastering limiter.

When you've completed your MIDI and audio tracks, you can turn the result into a two-channel audio CD. The OASYS is the only piece of equipment you need to take your creation all the way to its final state. With the extra-large color LCD to display relevant information, the intuitive operation allowed by the TouchView system, and the front panel control surface, the music-making power of the OASYS is under your complete control at all times. Audio data can be stored not only on the internal hard disk, but also on an external USB-connected hard disk.

Your completed MIDI and audio tracks can be mixed down to two channels, and burned to an audio CD using the internal CD-R/RW drive.

This audio data can also be stored on the internal hard disk drive.

Detailed Specifications

- Tracks: 16-track MIDI sequencer + 16-track hard disk recorder + 1 master track
- Number of songs: 200
- Resolution: 1/192nd of a quarter note
- Tempo: 40.00–240.00 (1/100 BPM steps)
- Maximum storage capacity: 400,000 MIDI events (MIDI data only) or 300,000 audio events (audio data only)
- MIDI tracks: 16 tracks + 1 master track, 156 preset and 100 user patterns (per song), 18 preset and 16 user template songs. Formats: Korg (OASYS) format, support for SMF formats 0 and 1
- Audio tracks: Maximum simultaneous playback of 16 tracks, maximum simultaneous recording of 4 tracks, WAVE file format. Maximum continuous recording time 80 minutes (monaural). Automation: volume, pan, EQ, send 1/2. Maximum 5,000 regions. Event Anchor function. BPM Adjust function
- RPPR: One pattern set available per song

6-channel audio input and 10-channel audio output to meet any situation

The OASYS provides a total of six audio inputs; four channels of analog input, and two channels of digital input. Analog inputs 1 and 2 use combo jacks that can accommodate either phone plugs or XLR plugs. With MIC/LINE select switches, phantom power switches, and level adjustment knobs, the inputs will accept any source from mic level to professional level. For digital input, the OASYS provides an S/P DIF jack (optical, 48 kHz/96 kHz). As outputs, there are the main L/MONO and R outputs as well as eight individual audio outputs and an S/P DIF (optical, 48 kHz/96 kHz) output. 24-bit resolution is used for the A/D and D/A converters that are such crucial elements for determining the audio quality of the input and output.

Superb user interface

Control surface and a rich variety of other controllers

The huge array of functions and parameters are displayed in a 10.4 inch color LCD for excellent visibility. The OASYS uses Korg's proprietary TouchView graphical user interface, letting you perform operations simply by touching the screen.

In addition to traditional controllers such as joystick, ribbon controller, and assignable keys, there's also a control surface consisting of numerous sliders, knobs, and switches.

The control surface provides sliders, knobs, and switches that give you tactile control for editing sounds via the Tone Adjust function, controlling the KARMA function, editing EQ or the volume or panning of each oscillator/timbre/track, or adjusting the source level for recording or sampling. You can also use the control surface to control external MIDI devices.

The LEDs located beside the sliders and around the knobs show the current status or the stored value for each controller, contributing greatly to the ease of use. With its excellent set of controllers and superb display, the OASYS provides full scope for your imagination and artistic expression whether you're performing on stage or working in the studio.

88-key model features the RH2 keyboard

The OASYS 88-key model features the RH2 (Real Weighted Hammer Action 2) keyboard that replicates the playing touch of an acoustic grand piano with heavier action on the lower keys and lighter action in the higher ranges, responding to every nuance of your playing.

Velocity-sensitive pads

The OASYS provides eight velocity-sensitive pads located in front of the large LCD screen. In Program mode you can assign up to eight note numbers (together with velocity values) to each pad, and in Combination mode you can also specify different MIDI channels to each pad. The Chord Assign switch makes it easy to input notes and velocities in a single operation. You can also use these pads in conjunction with the input channel settings of a KARMA module, so that striking a pad will make the KARMA function generate a phrase – yet another technique not available when using a keyboard alone. The pads have been newly designed for optimal action and best feel in any situation from performance to production.

On-board help functionality*

An on-board help function is built-in to assist you in taking advantage of the OASYS' astounding wealth of functionality. Illustrated explanations of the parameters and how to use the controllers are shown in the screen. You can also jump to the explanation for a desired function, or move through a history of the help items you've been looking at, letting you concentrate on your work without taking your eyes off the screen.

* English version only.

Storage expansion via USB 2.0

Four USB 2.0 connectors are built-in, making it easy to expand your storage via external hard disks, removable disks, flash media, and so on.

The OASYS' expandability

The OASYS uses an open architecture that allows it to be expanded without adding hardware.

The EXs series of high-capacity PCM library data that takes full advantage of the PCM synthesis engine, the EXi series which adds new synthesis engines that are organically integrated into the entire system, and the EXf series which adds new plug-in effects.

An ADAT optical output jack and word clock input jack can be added by installing the optional EXB-DI (hardware). This sends the eight channels of the analog audio output jacks (INDIVIDUAL 1–8) via ADAT optical format channels 1-8 as 24-bit 48 kHz digital signals. (You can make settings within the OASYS so that the MAIN L/MONO and R output is assigned to INDIVIDUAL 1–8.) This option also lets you use the word clock input jack to synchronize the OASYS with a connected digital audio device.

Front and rear panels

Front panel

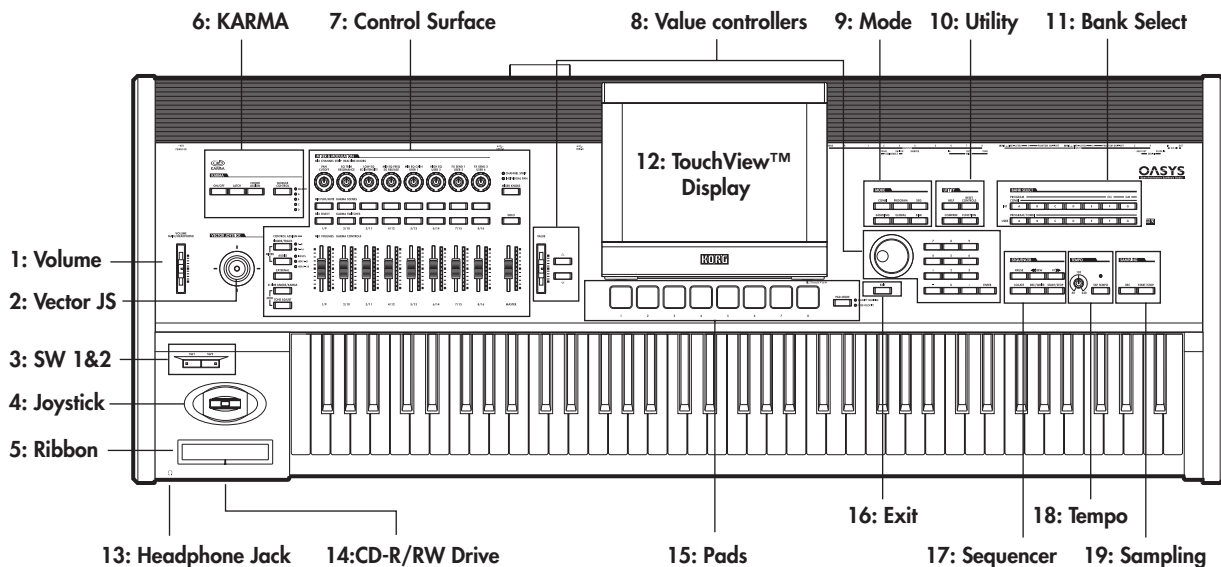

1. VOLUME slider (MAIN/HEADPHONE)

This adjusts the volume of the main L/R audio outputs, as well as the volume of the headphone jack.

It does not affect any of the other outputs, including S/P DIF, the individual outputs 1-8, or the optional ADAT output.

2. Vector Joystick

The Vector Joystick is a powerful real-time controller. Depending on the particular Program, Combi, or Song, it may modulate Program or effects parameters, or adjust the volumes of different components of the sound.

For more information on how Vector Synthesis works, see "Using Vector Synthesis" on page 64.

3. SW1 and SW2

These on/off switches can perform a number of different functions, such as modulating sounds or locking the modulation values of the joystick, ribbon, or aftertouch.

Also, each one may work either as a toggle, or as a momentary switch. In toggle mode, each press alternates between on and off; in momentary mode, the switch only changes for as long as you hold it down.

Each switch has an LED, which lights up when the switch is on.

Each Program, Combination, and Song stores its own settings for what the switches will do, and whether each switch defaults to being on or off.

4. Joystick

The joystick moves in four directions: left, right, forwards (away from yourself), and backwards (towards yourself). Each of the four directions can be used to control different program or effects parameters.

The specific assignments can change depending on the current Program, Combi, or Song. Generally, though, they will do something like the functions shown below:

Standard Joystick functions

Move the joystick...	Controller Name	Normally controls...
Left	JS-X	Pitch bend down
Right	JS+X	Pitch bend up
Forwards (away from yourself)	JS+Y	Vibrato
Backwards (towards yourself)	JS-Y	Filter LFO (wah)

5. Ribbon controller

The Ribbon controller lets you modulate Program or effects parameters by sliding your finger left and right along its touch-sensitive strip.

As with the other controllers, its specific function will change depending on the current Program, Combi, or Song.

6. KARMA buttons

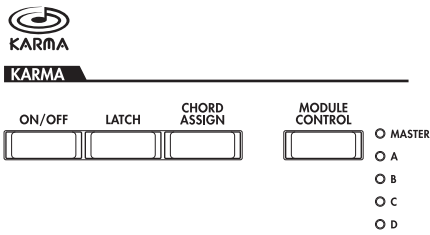

KARMA stands for “Kay Algorithmic Realtime Music Architecture.” It’s an immensely powerful recording and live performance tool, which can provide a wide range of musical effects including:

- Arpeggiation
- Drum and instrument grooves
- Complex CC gestures (as if it was automatically moving knobs or joysticks for you)
- Musical phrase generation, such as piano flourishes
- Gated and chopped dance production effects
- Any combination of the above
- ...and much more.

ON/OFF button

This switches the KARMA function on and off. As with the other KARMA buttons, the button’s LED will light up to show you that it is turned on.

LATCH button

When LATCH is turned on, KARMA will continue to play even after you’ve stopped holding notes on the keyboard, drum/chord pads, or MIDI In.

This is convenient when you want to play on top of a KARMA-generated groove, for instance.

CHORD ASSIGN button

This lets you assign notes and chords to the drum and chord pads. There are a several different ways to do this; here’s one of them:

1. Play a single note, or a chord of up to 8 notes.
2. Press the CHORD ASSIGN button.
3. Press the pad to which you’d like to assign the notes.

That’s it—the note or chord is now assigned to the pad. For more information, see “Drum & Chord Pads” on page 48.

MODULE CONTROL button

In Combi and Sequencer modes, KARMA has four independent Modules, each of which can be generating a different musical effect. When used to control KARMA, the Control Surface sliders and switches are five layers deep: one for each Module (A–D), and then a Master Layer which controls selected parameters from all of the Modules at once.

The **MODULE CONTROL** button selects whether the KARMA SLIDERS, SWITCHES, and SCENES will control either a single Module independently, or the Master Layer. In Program mode, only a single Module is available, and the Master Layer is used to control it; you cannot select other settings).

7. Control Surface (MIXER & MODULATION)

The Control Surface is the set of 9 sliders, 8 knobs, and 16 switches to the left of the LCD screen. It looks like a mixer, but can do a variety of things such as editing sounds, controlling the KARMA function, and sending MIDI messages to external devices. You can freely change back and forth between the different functions without losing any of your edits.

CONTROL ASSIGN buttons

As explained below, you can use the front panel CONTROL ASSIGN buttons to switch between the various control surface functions. You can also view and edit the control surface settings on the LCD screen (P0– Control Surface page in each mode).

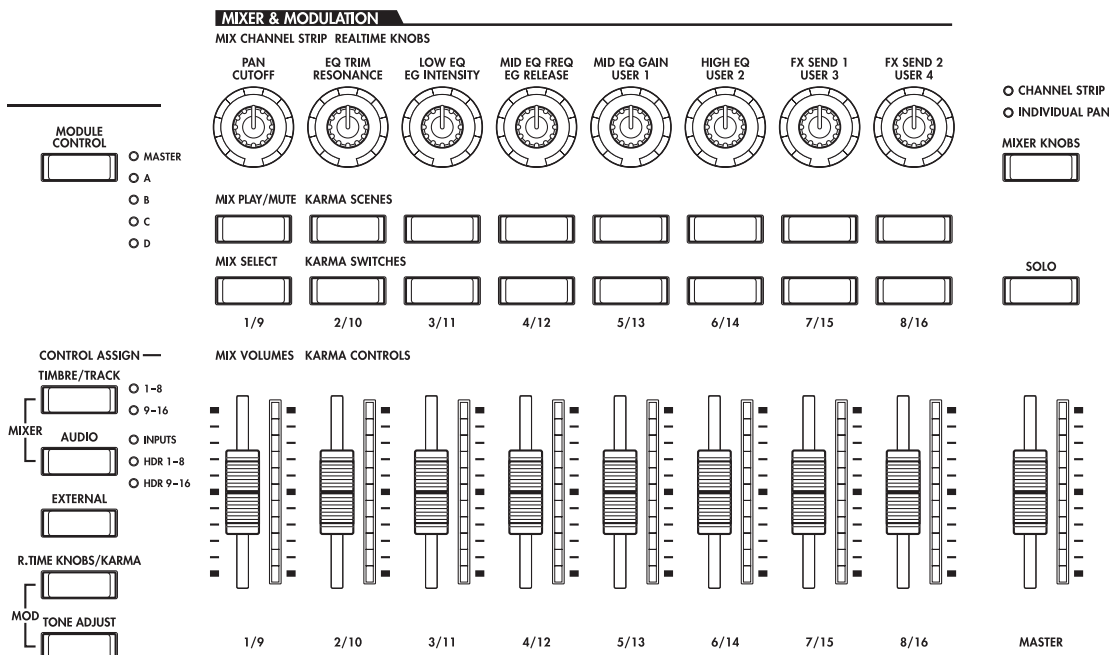

TIMBRE/TRACK

TIMBRE/TRACK lets you use the control surface to adjust the volume, pan, EQ, and send levels for OSC 1/2 or EXi 1/2 in Program mode, the current Multisample in Sample mode, and each of the 16 Timbres or Tracks in Combi and Sequence modes.

The LEDs to the right of the switch show whether you're currently editing Timbres (or Tracks) 1-8 or 9-16; press the **TIMBRE/TRACK** button to toggle between the two.

If you switch to one of the other Control Assign modes, and then go back to **TIMBRE/TRACK**, it will automatically return to the previously selected group (1-8 or 9-16).

AUDIO

AUDIO lets you use the control surface to adjust the volume, play/mute status, solo, pan, and send levels of the analog inputs and S/P DIF audio inputs. In Sequencer mode, you can also choose to control hard disk recording tracks 1-8 (HDR 1-8) or 9-16 (HDR 9-16).

As with **TIMBRE/TRACK**, if you switch to one of the other Control Assign modes, and then go back to **AUDIO**, it will automatically return to the previously selected group (Inputs, HDR 1-8 or HDR 9-16).

EXTERNAL

EXTERNAL lets you use the control surface to transmit MIDI messages to external MIDI devices.

R.TIME KNOBS/KARMA

R.TIME KNOBS/KARMA lets you modulate sounds and effects with the knobs, and control KARMA with the sliders and switches.

TONE ADJUST

TONE ADJUST gives you hands-on access to sound editing, using the sliders, knobs, and switches. In Combi and Sequence modes, it also lets you edit Programs within the context of the Combi or Song, without making any changes to the original Program data.

More information on the Control Surface

For more information on how the Control Surface works in the different modes, see:

- Program mode: "0-9: Control Surface" on page 18 of the Parameter Guide
- Combi mode: "0-9: Control Surface" on page 333 of the Parameter Guide
- Sequence mode: "0-9: Control Surface" on page 437 of the Parameter Guide

Knob & Slider LEDs

Each knob has a ring of LEDs, which shows the current value of the knob's parameter. Similarly, each slider has a strip of LEDs. As you select different **CONTROL ASSIGN** buttons, you'll notice that all of the LEDs change to show the values for the newly selected mode.

The knobs and sliders have a much wider range of values than there are LEDs in the rings and strips, so the values shown are only approximate. Also, note that the minimum value of the slider is shown by having no LEDs lit.

MIXER KNOBS button

This applies only when **CONTROL ASSIGN** is set to **TIMBRE/TRACK** or **AUDIO**. It toggles the knobs between controlling the pan of all channels or controlling the pan, EQ, and sends of the currently selected channel.

SOLO button

This applies only when **CONTROL ASSIGN** is set to **TIMBRE/TRACK** or **AUDIO**. It toggles the **SELECT** buttons between selecting the current Oscillator, Timbre, Track, or Audio Input (when **SOLO** is off) or soloing the channel (when **SOLO** is on).

For more information on **SOLO** in the various modes, see:

Program mode: "Solo switch and Select switches 1-2" on page 21 of the Parameter Guide

Combi mode: "Solo switch and Select switches 1-8" on page 336 of the Parameter Guide

Sequencer mode: "Solo switch and Select switches 1/9-8/16" on page 440 of the Parameter Guide

8. VALUE entry

When you've selected a parameter on the TouchView™ display, you can edit it using any of the four front-panel value entry controls:

- The VALUE slider
- The Inc Δ and Dec ∇ buttons
- The VALUE dial
- The numeric keypad

VALUE slider

Use this to edit the selected parameter's value. This control is convenient for making large changes to the value, such as moving quickly to the minimum or maximum setting.

You can use the value slider as a modulation source, but only when the following are true:

- You're on the Program mode P0-Main page, and the big Program name is selected, or
- You're on the Combination mode P0- Prog Select/Mixer page, and the big Combination name is selected.

In these cases only, the value slider sends MIDI CC#18, and can be used as a modulation source.

Inc Δ and Dec ∇ buttons

These are used to increase or decrease the parameter value by individual steps. They're convenient for making fine parameter adjustments.

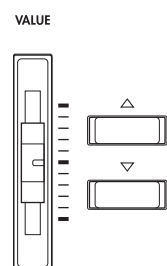

VALUE dial

Use this dial to edit the selected parameter's value. This control is convenient when you want to scroll through a very long list of selections.

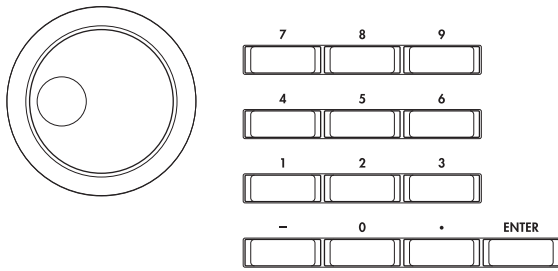

0-9, -, ., and ENTER buttons

These buttons are convenient when you know the exact value that you want to enter. Use the 0-9, -, and decimal (.) buttons to enter the value, and then press the ENTER button to confirm the entry.

The - button inverts the sign (+/-) of the parameter value; the decimal (.) button inserts a decimal, for entering fractional values.

Special functions of the ENTER button

ENTER has a few special functions when it is pressed in combination with other buttons.

Whenever an on-screen parameter lets you enter a musical note (such as G4 or C#2), or a velocity level, you can enter the note or velocity directly by holding down ENTER while playing a note on the keyboard.

By holding down the ENTER button while you press a numeric button (0-9), you can select up to ten menu commands from the current page.

In Program and Combination modes, you can hold down the ENTER button and press the SEQUENCER REC/WRITE button to use the Auto Song Setup function. This imports the current Program or Combi into Sequence mode for quick and easy recording.

9. MODE buttons

OASYS has six different operational modes, each one optimized for a specific set of functions. These buttons select the current mode.

Each button has an LED, which lights up to show the mode you've selected.

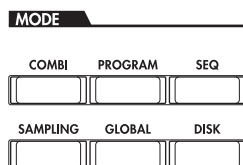

COMBI button

This selects Combination mode, for playing and editing complex splits and layers of Programs.

PROG button

This selects Program mode, for playing and editing basic sounds.

SEQ button

This selects Sequencer mode, for recording, playing, and editing audio and MIDI tracks.

SAMPLING button

This selects Sampling mode, for recording and editing audio samples and multisamples.

GLOBAL button

This selects Global mode, for making overall settings, editing Wave Sequences and Drum Kits, and more.

DISK button

This selects Disk mode, for saving and loading data to and from the internal hard drive or CD-RW drive, or from external USB 2.0 storage devices.

10. UTILITY buttons

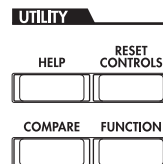

HELP button

The HELP button gives you built-in, context-sensitive access to the user manuals, right from the front panel.

For information on any front-panel button, knob, slider, or real-time controller, just hold down HELP and then press the button or move the controller in question.

For information on the current LCD page, press and release the HELP button.

While the help page is on the screen, you can touch any of the on-screen links (highlighted in blue text) for more information. You can scroll through the text by using the on-screen scroll bars, pressing the Inc and Dec buttons, or spinning the Value dial.

The top of the Help page has "breadcrumb" links, which show the hierarchy of pages above the current one. Touch any of these links to jump to the corresponding page.

The backwards and forwards buttons function like the similar buttons on a standard web browser. If you use links to jump between pages, you can then use the backwards and forwards buttons to move through the pages you've already viewed.

The Contents page lets you access any part of the Help system, including almost all of the text and graphics in both the Parameter and Operation Guides. The Index contains a shorter list of links to important articles.

To close the help display, just press the HELP button again, or press the on-screen Done button.

RESET CONTROLS button

This feature lets you reset the Vector Joystick to the center position, or reset any of the Control Surface sliders, knobs, or switches to their saved value.

To reset a single control, hold down RESET CONTROLS and then move a Control Surface slider or knob, press one of the control surface buttons, or move the Vector Joystick.

To reset an entire page of the Control Surface all at once, including all sliders, knobs, and switches, hold down RESET CONTROLS and then touch any of the Control Assign buttons, such as TIMBRE/TRACK or TONE ADJUST.

COMPARE button

Use this button to compare the sound of the Program or Combination that you are currently editing with the saved, un-edited version of the sound. You can also use this button to make “before and after” comparisons when recording or editing in Sequencer mode.

FUNCTION button

This button is reserved for future use.

11. BANK SELECT buttons

Use these buttons to change banks when selecting Programs or Combinations. The LEDs in the buttons light up to show the current bank.

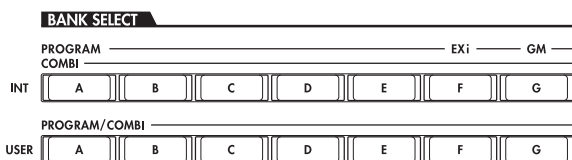

In Program mode, these buttons select the Program bank. They are active only on the Play pages.

In Combination mode, these buttons have two functions:

- When you’re selecting Combinations, they choose the Combination bank.
- When you’re assigning a Program to a timbre within the Combi, they select the Program bank.

In Sequencer mode, when a track’s Program name is selected, these buttons change the Program bank.

General MIDI banks

Selecting General MIDI Program banks is a little different from selecting other banks. Each time you press the INT-G button, the bank will step to the next GM(2) bank or GM drum bank in the following order: G, g(1), g(2)–g(8), g(9), g(d), G, g(1), etc.

What’s in each bank?

For details on the contents of the Program banks, see “Program Bank Contents” on page 2. For details on the Combi banks, see “Combination Bank Contents” on page 3.

12. TouchView display

The OASYS features our exclusive TouchView graphic interface, based on a touch-panel LCD screen.

By touching items on the LCD screen, you can select pages, tabs, and parameters, and set parameter values via on-screen menus and buttons.

13. Headphone jack

This stereo 1/4” headphone jack carries the same signal as the Main L/R outputs.

The headphone volume is controlled by the VOLUME slider.

14. CD-R/RW drive

The built-in CD-R/RW drive lets you save and load sound and sample data, back up your sequences and audio recordings, and burn your final mixes as audio CDs.

- ⚠ This drive is a precision device. When using it—especially when burning CDs—the keyboard must be in a horizontal position, and not be subject to vibration. Specifically, don’t try to burn a CD and play on the keyboard at the same time.

15. Drum/Chord Pads

These velocity-sensitive pads can trigger single notes or chords of up to eight notes each. You can use them for playing or programming drums, for triggering chords (especially useful in conjunction with KARMA), or for selecting chords to play from the keyboard in Chord mode. For information about Chord mode, see “Using Chord mode” on page 49.

Assigning notes to the pads is fast and easy; see “CHORD ASSIGN button” on page 19 for details.

The notes and/or chords assigned to the pads are stored with each Program, Combi, and Song. There are also Global settings for use when the Control Surface is set to EXTERNAL, for easy control of external sound modules or plug-ins.

PAD MODE button



The PAD MODE button switches the pads between being velocity sensitive (so that the loudness varies depending on how hard you hit the pad) and playing a single, fixed velocity for each note (handy if you want the same results every time, regardless of how hard you play).

16. EXIT button

This button makes it easy to return to the main page of the current mode:

- Press it once to go to the previously-selected tab on the main P0 page.
- Press it again to go to the first tab on the main P0 page (such as the main Program Play page). If you had previously selected a parameter on this page, that parameter will be selected.
- Press it a third time to select the main parameter on the P0 page, such as the Program name in Program mode.

Wherever you are in Program, Combi, or Sequencer modes, pressing EXIT three times (or fewer) will take you back to Program/Combination/Song Select,

where you can immediately use the numeric keys or Δ/∇ switches to select a Program, Combination, or Song.

When a dialog box is open, this button cancels the settings made in the dialog box and closes the dialog box, just like pressing the Cancel button. If a popup menu or page menu is open, pressing EXIT closes the menu.

17. SEQUENCER buttons

Most of the buttons in this section apply only to Sequencer mode and audio CD playback (in Disk Mode).

REC/WRITE is the exception; it has special functions in Program, Combination, and Global modes, as described below.

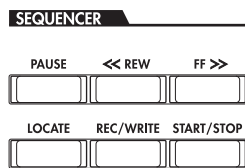

PAUSE button

In Sequencer mode, this button pauses the playback of the song. When paused, the button's LED will light up. Press PAUSE once again to resume playback, and the LED will turn off.

In Disk mode, this button pauses audio CD playback.

<<REW button

In Sequencer mode, when the Song is playing or paused, this button will rewind the song. When you press and hold this button, its LED will light up, and the playback will rewind. (Rewind is disabled during recording, and while the Song is stopped.)

In Disk mode, this button rewinds the audio CD.

FF>> button

In Sequencer mode, when the Song is playing or paused, this button will fast-forward the song. When you press and hold this button, the button will light, and the playback will fast-forward. (Fast-forward is disabled during recording, and while the Song is stopped.)

In Disk mode, this button fast-forwards the audio CD.

LOCATE button

In Sequencer mode, this button will advance or rewind the song to the specified locate point. This lets you jump immediately to any point in the current Song. The default locate point is the first beat of measure 1.

To set the locate point to the current position, hold down ENTER and then press LOCATE. You can also set the Locate point directly via the on-screen menu.

REC/WRITE button

In Sequencer mode, pressing this button will enter record-ready mode. Once you're in record-ready mode (shown by the button's lit LED), you can begin

recording by pressing the SEQUENCER START/STOP button. For more information, see "Recording MIDI in real-time" on page 85.

In Program, Combination and Global modes, pressing REC/WRITE will open the Save dialog box. For more details, see "Writing to internal memory" on page 164, and "Using the (SEQUENCER) REC/WRITE switch to write" on page 165.

In Program and Combination modes, you can hold down the ENTER button and press the SEQUENCER REC/WRITE button to use the Auto Song Setup function. This imports the current Program or Combi into Sequence mode for quick and easy recording. For more information, see "Auto Song Setup" on page 2 of the Parameter Guide.

START/STOP button

This starts or stops recording and playback in Sequencer mode.

In Disk mode, this button starts and stops playback on the audio CD.

18. TEMPO controls

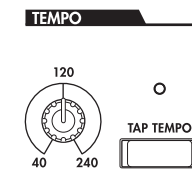

TEMPO knob

This adjusts the tempo for the OASYS as a whole, including:

- Tempo-synced LFOs
- Tempo-synced ("BPM") delay effects
- EXi Step Sequencers
- KARMA
- Songs in Sequence mode

The LED will blink at quarter-note intervals of the current tempo.

NOTE: If the GLOBAL MIDI page MIDI CLOCK parameter is set to **External**, or if it is set to **Auto** and a clock is currently being received via MIDI, then neither the TEMPO Knob nor the TAP TEMPO button will have any effect.

TAP TEMPO button

This lets you enter tempos simply by tapping your finger on the button. Two taps are enough to change the tempo; for greater accuracy, you can continue tapping, and the tempo will be averaged the most recent 16 taps.

19. SAMPLING buttons

SAMPLING



REC button

In Sampling, Program, Combination, and Sequencer modes, pressing this button enters the initial sampling-ready mode. The button's LED will light up.

To continue, press the SAMPLING START/STOP button, as described below.

START/STOP button

In Sampling, Program, Combination, and Sequencer modes, pressing this when the SAMPLING REC button is lit will do one of three things, depending on the setting of the **Trigger** parameter (on the Sampling mode Recording - Audio Input page):

- If **Trigger** is set to **Sampling START SW**, sampling will begin immediately.
- If **Trigger** is set to **Note On**, sampling will begin as soon as you play a note on the keyboard.
- If **Trigger** is set to **Threshold**, sampling will begin as soon as the selected audio source reaches a preset volume level.

On the Sampling mode's P1: Sample Edit page, pressing this button will play the selected sample.

This button is also used to play back WAV files from the disk. You can play back WAV files in the directory window of various Disk mode pages, in the Disk mode Make Audio CD page, in the Sequencer mode audio track editing dialog boxes, and in the **Select Directory** menu dialog box of the Program, Combination, Sequencer, and Sampling modes.

Rear panel

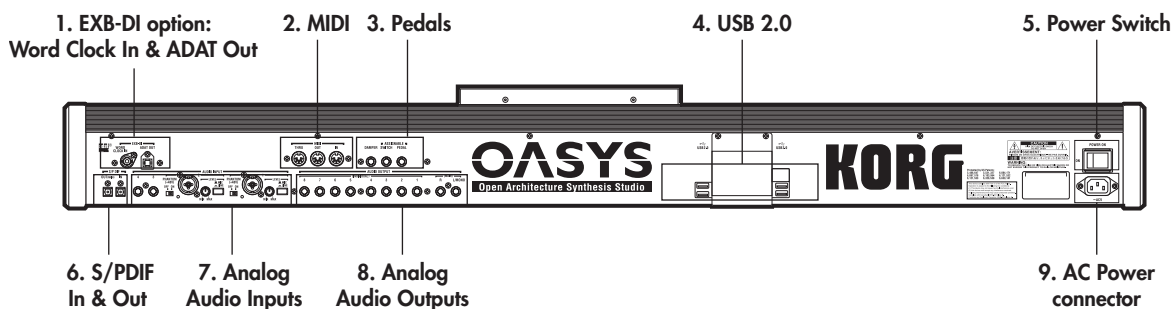

1. EXB-DI option

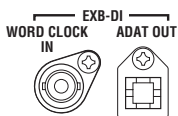

The optional EXB-DI provides word clock input and 8-channel ADAT optical output.

WORD CLOCK IN

This allows the sample rate of the OASYS to be controlled by an external device. Connect this to the word clock output of the master clock source.

The Word Clock input requires a shielded, video-quality cable (75-ohm or greater impedance) with BNC connectors. This type of cable is different from those commonly used in analog audio applications, but is readily available at professional audio and video dealers.

ADAT OUT

The ADAT optical output carries eight channels of 24-bit digital audio, mirroring analog individual outputs 1-8. You can use the Global Audio page **L/R Bus Indiv. Assign** parameter to map the main stereo outputs to any of these output pairs, if you like.

Connect this to any computer audio system, multitrack recorder, digital mixer, effects processor, or other digital audio device which supports the ADAT optical format.

2. MIDI

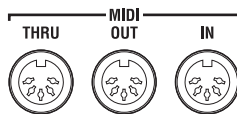

MIDI lets you connect OASYS to computers or other MIDI devices, for sending and receiving notes, controller gestures, sound settings, and so on. For more information on MIDI connections, please see "MIDI applications" on page 1001 of the Parameter Guide.

MIDI THRU connector

MIDI data received at the MIDI IN connector is re-transmitted without change from the MIDI THRU connector.

You can use this to chain multiple MIDI devices together.

MIDI OUT connector

This connector transmits MIDI data. Use this to control external MIDI devices, or to record into an external sequencer.

MIDI IN connector

This connector receives MIDI data. Use this to play the OASYS from another MIDI device, or from an external sequencer.

3. Pedals

← ASSIGNABLE →
DAMPER SWITCH PEDAL



DAMPER jack

For the damper—also known as the sustain pedal—you can connect either a standard footswitch, or Korg's special half-damper pedal, the optional DS-1H.

The DS-1H is a continuous pedal designed specifically for piano-style damper control, with the look and feel of an acoustic piano's sustain pedal. It allows more subtle control of the damper than a simple switch; the further down you press the pedal, the more that the sound sustains. For more information, see "Half-Damper Pedal and Release Time" on page 36 of the Parameter Guide.

You can also connect a simple footswitch, which will work as a standard on/off damper pedal.

In order to ensure that the pedal functions correctly, please adjust the switch polarity (see "Damper Polarity" on page 659 of the Parameter Guide) and the half-damper sensitivity (see "Half Damper Calibration" on page 683 of the Parameter Guide).

ASSIGNABLE SWITCH jack

This lets you connect a simple on/off footswitch, such as the optional Korg PS-1. The footswitch can perform a wide variety of functions, such as modulating sounds and effects, tap tempo, sequencer start/stop, etc.

The switch's function is set in Global mode (on the Controller tab of the Controllers/Scales page), so that it always works the same regardless of the current Program, Combi, or Song. For more information, please see "Specifying the function of the ASSIGNABLE Switch and ASSIGNABLE Pedal" on page 149.

ASSIGNABLE PEDAL jack

This lets you connect a continuous controller pedal, such as the Korg EXP-2 foot controller or Korg XVP-10 EXP/VOL pedal, to use as an assignable modulation source.

Like the ASSIGNABLE SWITCH, the pedal's function is set in Global mode. For more information, please see "Specifying the function of the ASSIGNABLE Switch and ASSIGNABLE Pedal" on page 149.

4. USB 2.0 ports

There are four external, high-speed USB 2.0 ports. You can use these to connect storage media such as hard disks, flash media, etc. For more information, see "6. Connecting USB devices" on page 39.

5. POWER switch

This switch turns the power on and off. Before turning OASYS off, make sure that you've saved any edits to your Programs, Combis, Songs, or other user data.

⚠ After turning the power off, please wait for at least ten seconds before you turn the power on again.

6. S/P DIF IN & OUT

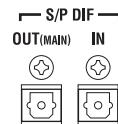

These jacks provide 24-bit optical S/P DIF input and output, for connecting to computer audio systems, digital mixers, DATs, MDs, etc.

Optical S/P DIF is sometimes called TOSLINK, and formally named (hold your breath!) IEC60958, EIAJ CP-1201. Make sure to use optical cables designed for digital audio.

Whenever you use digital audio connections, make sure that all connected systems are set so that there is one and only one word clock master. You can set the word clock for the OASYS using the Global page **System Clock** parameter. For more information, see "System Clock" on page 644 of the Parameter Guide.

OUT(MAIN) jack

This optical S/P DIF output carries a digital version of the main L/R outputs.

Note that the VOLUME slider does not adjust the S/P DIF output level.

IN jack

You can use this optical S/P DIF input for recording, sampling, and real-time mixing through the built-in effects.

It can be used simultaneously with the four analog inputs, if you like.

7. Analog AUDIO INPUTS

You can use the audio inputs for recording, sampling, and real-time mixing through the built-in effects.

Mic/Line Inputs 1 and 2

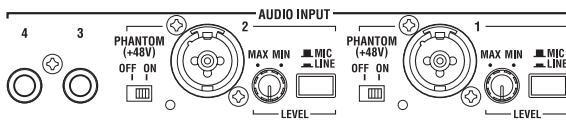

Inputs 1 and 2 provide combined XLR and 1/4" TRS balanced connectors. You can use these for either microphone-level or line-level signals. The two inputs have identical sets of controls, as described below.

MIC/LINE switches

These set the input's nominal signal level. Set these switches according to the type of device that you're connecting, and then use the LEVEL knobs (described below) to optimize the gain.

Use the LINE setting (button pressed in) when connecting to mixers, computer audio systems, signal processors, or other synthesizers. The nominal level is +4dBu, with 12dB of headroom.

Use the MIC setting (button popped out) only when connecting a microphone.

LEVEL knobs

These knobs let you make more precise adjustments to the input level, after setting the basic levels with the MIC/LINE switches.

The MIN setting is unity gain; the MAX setting provides about 40dB of gain above unity.

PHANTOM POWER switches

These switches enable 48 volt phantom power on the XLR connectors only. This sends a small amount of power to external microphones, using the same wires that carry the audio signals back to the OASYS. Most professional condenser microphones require phantom power; see the microphone's manual if you are unsure.

If you are not using a microphone which requires phantom power, it's best to turn these switches to the OFF position.

WARNING: Never plug in unbalanced instruments or microphones to the XLR connectors when PHANTOM POWER is on.

Line Inputs 3 and 4

Inputs 3 and 4 are for line-level signals only. They use unbalanced 1/4" phone jacks, referenced to a +4dBu signal level with 12dB of headroom.

The sound from each oscillator, drum, timbre/track, or insert effect can be freely routed to any output. Additionally, you can route the metronome sound to an individual output, to separate it from the stereo mix. For more information, see "Routing effect settings" on page 185.

(MAIN) L/MONO, R

These are the main stereo outputs; their volume is controlled by the VOLUME slider. All of the factory Programs and Combis are programmed to play through these outputs.

When editing sounds, or when setting up a Song in Sequencer mode, you can access the main outputs by setting **Bus Select** to L/R.

If no cable is connected to the R output, L/MONO will carry a mono summation of the stereo signal. So, if you are connecting to a device which does not have stereo inputs (such as a simple keyboard amp), use the L/MONO output.

(INDIVIDUAL) 1...8

These 8 additional audio outputs let you isolate sounds, audio inputs, or audio tracks for recording or complex live sound setups.

These can be used as stereo or mono outputs, in any combination. You can also use the Global Audio page **L/R Bus Indiv. Assign** parameter to map the main stereo outputs to any of these output pairs, if you like.

Note that the individual outputs are not affected by the VOLUME slider.

9. AC Power connector

Connect the included power cable here.

We recommend that you first connect the power cable to the OASYS, and then connect the other end of the cable to an AC outlet (see p.37).

8. Analog AUDIO OUTPUTS

All of the analog audio outputs use unbalanced 1/4" phone jacks, referenced to a +4dBu signal level.

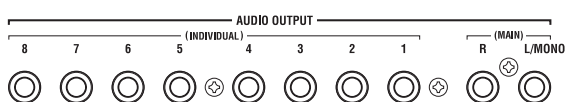

Connect these outputs to the input jacks of your amp or mixer. In addition to the L/MONO and R main stereo audio outputs, the OASYS provides eight individual audio outputs.

Names and functions of objects on the LCD display

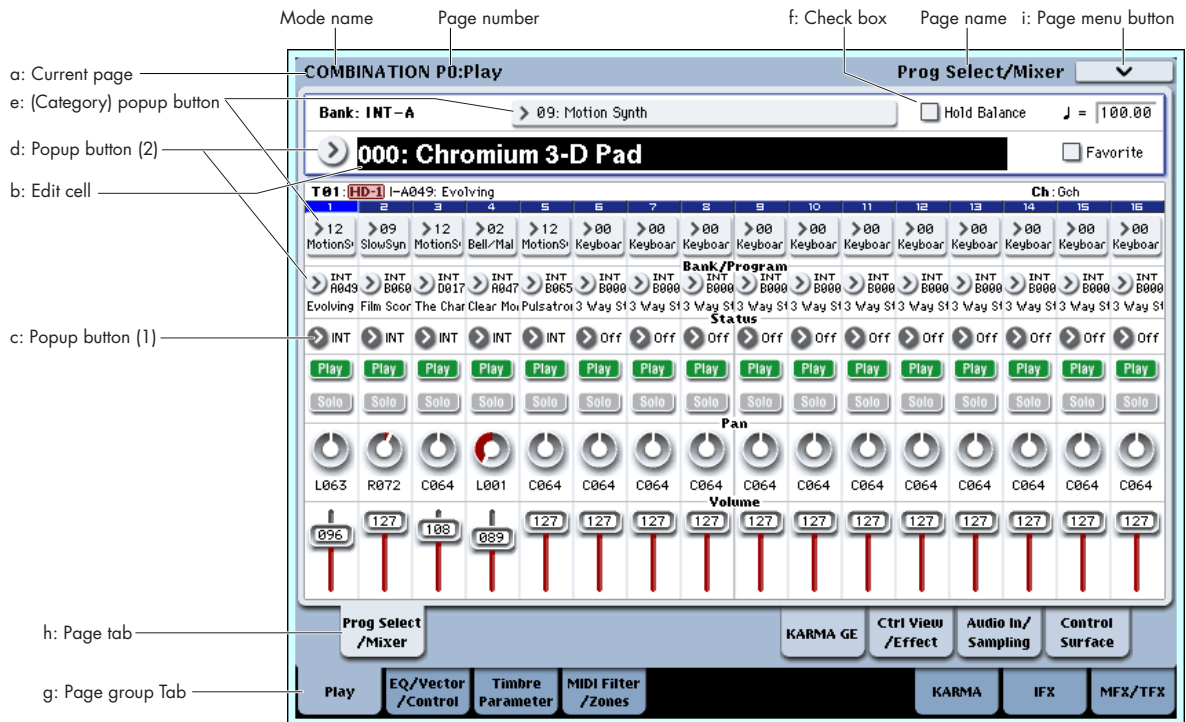

The OASYS uses Korg’s TouchView graphical user interface.

By touching on objects displayed in the LCD screen, you can select pages, set parameter values, rename programs and combinations, write data, and perform many other operations.

a: Current page

This indicates the selected page within the current mode.

From the left, this shows the current mode, the number and name of the page group, and finally the name of the individual page.

b: Edit cell

When you touch a parameter in the LCD screen, the parameter or parameter value will usually be highlighted (displayed in inverse video). This is called the **edit cell**, and the highlighted item will be subject to editing.

The parameter value of the edit cell can be modified using the VALUE controllers (p.35) or by using a popup button in the LCD screen. For parameters that accept a note number or a velocity value, you can also hold down the ENTER switch and play a note on the keyboard to enter the note number or velocity value.

c: Popup button

When this button is pressed, a popup menu will appear, showing the parameter values that are available for selection.

To enter the parameter value, press the desired value in the popup menu.

When a popup menu is displayed, using a VALUE controller (p.35) will close the popup menu. If the popup menu is unlocked (“Pin”), it will close if you touch a location outside the popup menu.

* Popup menu

Pin

This switches the popup menu display between locked and unlocked.

When locked, the pin will be shown closed, and the popup menu will remain displayed even after you press a parameter value. When unlocked, the pin will be shown opened, and the popup menu will close immediately when you press a parameter value.

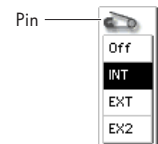

d: Select button

When you press this button, a tabbed **popup menu** will appear, allowing you to perform the following selections.

- “Bank/Program Select,” “Bank/Combination Select”: Select programs or combinations by bank
- “Multisample Select”: Select a multisample for a program oscillator by category
- “Wave Sequence Select”: Wave sequences for program oscillators can be chosen by category
- “Effect Select”: Select an effect by category
- Select a sample
- Select a KARMA GE

To close a tabbed popup menu, press the OK button or Cancel button.

Scroll bar

Use this when you wish to see parameter values that extend beyond what can be displayed in the screen at one time.

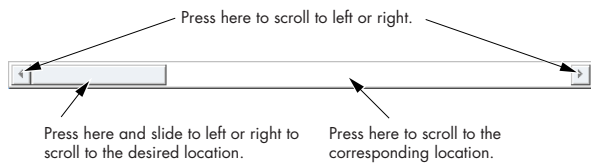

e: Category button

When you press this button, a tabbed **popup menu** will appear, allowing you to perform the following selections.

- “Category/Program Select,” “Category/Combination Select”
 - Category/GE Select
- Press the OK or Cancel buttons to close the tabbed category select popup menu.

f: Check box

Each time you press a check box, it alternates between the checked (red) and unchecked states.

The parameter will be active if it is checked, and inactive if it is unchecked.

g & h: Page group tabs and Page tabs

Press the lower row of tabs to select the page group, and then press the upper row of tabs to select the page.

The left side of the current page display shows the number and group name of the page you’ve selected in the lower row of tabs. The right side of the current page display shows the name of the page you’ve selected in the upper row of tabs.

i: Page menu button

When this button is pressed, a list of menu commands will appear.

The menu commands that appear will differ depending on the page you’ve selected.

You can also select up to ten menu commands by holding down the ENTER switch and pressing a numeric key 0–9. The page menu will close when you press the LCD screen at a location other than the page menu, or when you press the EXIT switch.

*** Dialog box**

The dialog box that appears will depend on the currently selected menu command.

When selecting a program or combination number in a dialog box, use the VALUE controllers (p.35) to input the number.

To execute, press the OK button. To cancel without executing, press the Cancel button. (The operation will occur when you press and release the button.) The dialog box will close. The EXIT switch corresponds to the Cancel button, Done button, and Exit button.

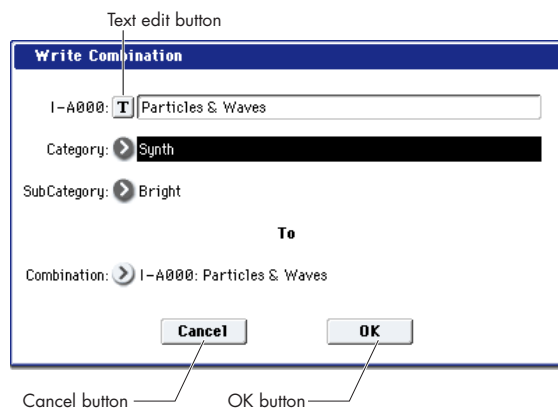

*** Text edit button**

Pressing this button brings up an on-screen keyboard, for changing the name of Programs, Combis, Songs, Wave Sequences, Drum Kits, etc. For more information, see “Editing names” on page 166.

j: Radio buttons

Press a radio button to select one value from two or more choices.

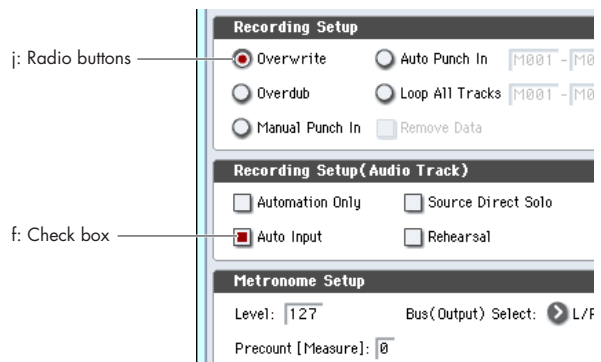

k: Other objects

To modify the parameter value of an object shaped like a slider or knob, first touch the object, and then use the VALUE controllers to modify the value. There are also buttons which execute an operation when they are pressed and released, such as Done, Copy, and Insert (similar to the OK and Cancel buttons explained under “* Dialog box,” above).

Toggle buttons

This type of button will change its function or switch on/off each time it is pressed.



Play/Rec/Mute button in Sequencer mode



Solo On/Off button in Sequencer mode



Use the numeric keypad [0]-[9]

Basic Information

About the OASYS' modes

The OASYS has a large number of features that let you play and edit programs and combinations, record and play sequence data, record and play back samples, and manage data on disk. The largest unit used to organize these features is called a mode.

The OASYS has six modes.

Program mode

Programs are the basic sounds of OASYS. In Program mode, you can:

- Select and play Programs
- Edit Programs

Make detailed settings for oscillators, filters, amps, EGs, LFOs, effects, KARMA, vector synthesis, etc. The specific parameters will vary depending on the

synthesis type: HD-1, AL-1, CX-3, STR-1, or other EXi instruments.

- Create drum programs using drum kits (as created in Global mode)
- Play and control one KARMA module
- Sample and resample

For example, you can sample an external audio source while listening to a performance generated by the KARMA function, or you can play a Program and resample your performance.

Combination mode

Combinations are sets of up to 16 Programs that can be played simultaneously, letting you create sounds more complex than a single Program. In Combination mode, you can:

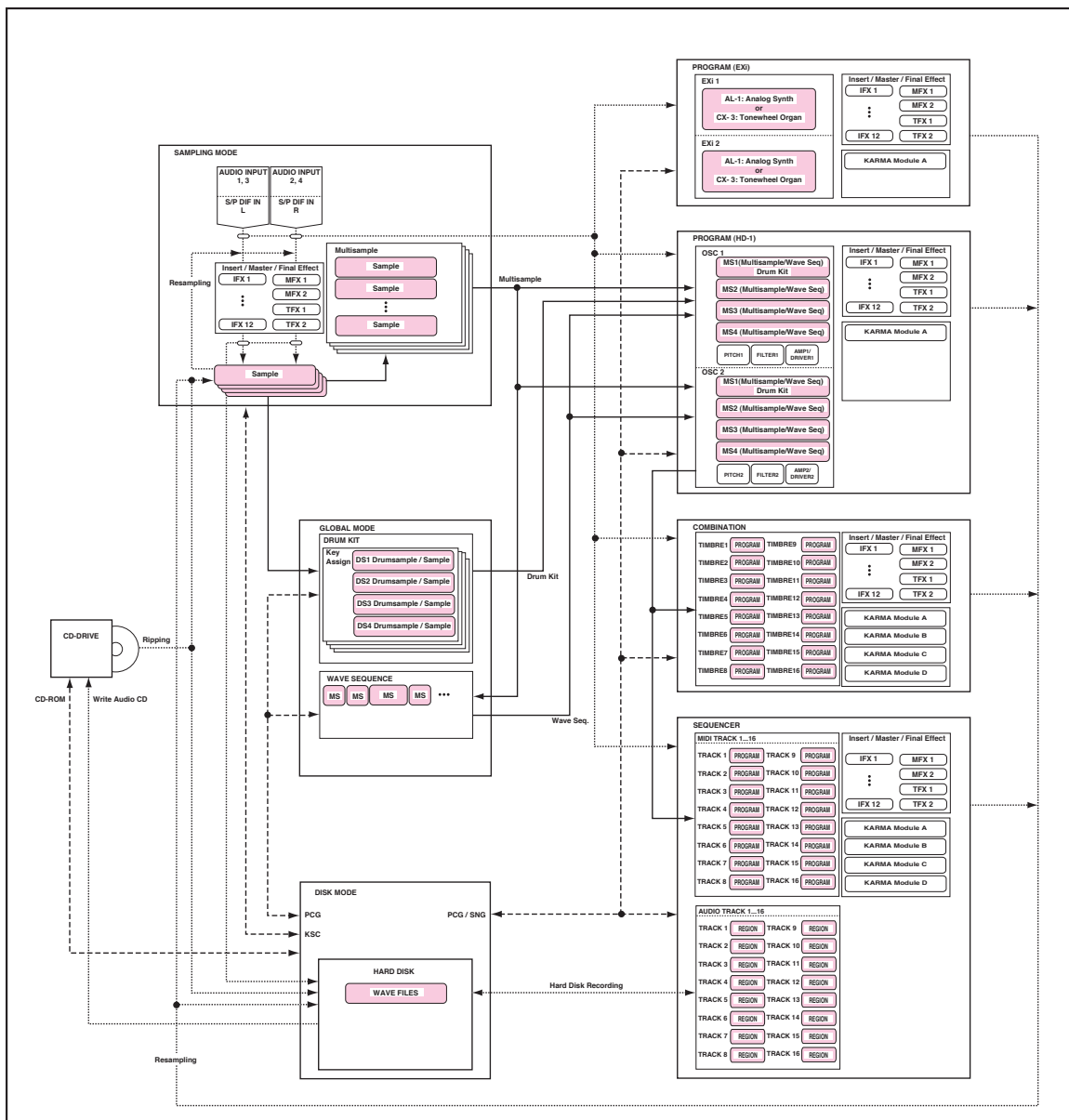

- Select and play Combinations
- Use OASYS as a 16-track multitimbral tone generator
- Edit Combinations

Assign Programs to each of the 16 Timbres, each with separate volume, pan, EQ, and keyboard and velocity zones; make settings for effects, vector synthesis, and KARMA.
- Control and play up to four KARMA modules
- Sample or resample

For example you can sample an external audio source while listening to the performance of the KARMA, or resample a performance you play using a combination.

Sequencer mode

Sequencer mode lets you record, play back, and edit MIDI tracks and audio tracks. You can:

- Select and play Songs
- Edit Songs

Assign Programs to each of the 16 MIDI Tracks, each with separate volume, pan, EQ, and keyboard and velocity zones; make settings for effects, vector synthesis, and KARMA; edit MIDI data
- Record up to sixteen MIDI tracks simultaneously
- Record up to four of the sixteen audio tracks simultaneously, mix using automation, and import WAVE files.
- Control and play up to four KARMA modules
- Sample or resample

You can sample an external audio input source while playing a song, and use In-Track Sampling to automatically create a note event that triggers the sample at the same time as it was recorded.

You can also resample an entire song, and then use Disk mode to create an audio CD.
- Use OASYS as a 16-track multitimbral tone generator
- Record patterns and assign them to individual keys, using RPPR (Realtime Pattern Play/Recording)

About the OASYS' PCM memory

"PCM" is another way of saying "samples." The OASYS includes the following PCM memory banks.

ROM: 314 MB

When you turn on the power, the ROM will always be loaded and available. This contains the basic multisamples and samples.

Sampling mode

Sampling mode lets you record and edit user samples and multisamples. For example, you can:

- Sample external audio sources (i.e., record samples), including sampling through effects
- Edit waveform data you sampled or loaded in from media, and set loop points etc.
- Create and edit multisamples, which consist of one or more samples spread out across the keyboard
- Quickly convert multisamples into Programs
- Digital data can be sampled ("ripped") directly from an audio CD in the CD-R/RW drive. You can also play back audio CDs.

Global mode

Global mode lets you make overall settings for the entire OASYS, and edit wave sequences and drum kits. For instance, you can:

- Make settings that affect the entire OASYS, such as master tune and global MIDI channel
- Create user drum kits, wave sequences, and user scales
- Create drum kits using ROM, EXs, or RAM drum samples
- Rename program, combination, and KARMA GE categories
- Set the function of the assignable pedals and assignable switches
- Transmit MIDI System Exclusive data dumps

Disk mode

Disk mode lets you save, load, and manage data using the internal hard disk, the internal CD-R/RW drive, and external USB 2.0 storage devices. You can:

- Save and load Programs, Combinations, Songs, Samples, and Global setup data
- Format disks and storage media, copy and rename files, etc.
- Load AKAI, AIFF, and WAVE samples, and export RAM samples in AIFF or WAVE formats
- Export and import sequences to and from SMF (Standard MIDI Files)
- You can use the Data Filer function to save or load MIDI System Exclusive data
- Create and play back audio CDs

With the factory settings, programs that use this PCM data are loaded into program banks INT-A, B, C, and D.

To use these samples when making your own sounds, select Bank ROM (Stereo, Mono) for a program’s **MS Select** (Program P2: OSC/Pitch-OSC Basic) or a drum kit’s **“DS Select”** (Global P5: Drum Kit– Sample Setup) fields.

EXs1 ROM Expansion: 313 MB

EXs1 includes spectacular stereo drums and additional large acoustic and synthesizer multisamples, capturing extra detail and character.

As shipped from the factory, these samples will be loaded and available at start-up, along with the ROM samples. This can be changed using the Global mode **Expansion Sample Setup** menu command, if desired.

Some of the factory preloaded sounds require EXs1 to be loaded. This includes some of the Programs in bank INT-E, and some of the Combinations in bank INT-C. These sounds either use EXs1 samples directly, or use Wave Sequences or Drum Kits which in turn rely on EXs1.

All of these Programs, Combinations, Wave Sequences, and Drum Kits all have “EXs1” in their names, to remind you that they require EXs1.

Note: if EXs1 is not loaded, these sounds won’t play correctly.

To use EXs1 samples when making your own sounds, choose Bank EXs1 (Stereo, Mono) for a program’s **MS Select** or a drum kit’s **DS Select** fields.

EXs2 Concert Grand Piano: 503 MB

The EXs-2 Concert Grand Piano serves up a singular, breathtaking piano experience. Based on individually sampled keys, true stereo imaging, four-way velocity switching and an additional damper layer, this piano evokes unparalleled realism.

- These samples will be loaded and available at start-up depending on the setting of the **Expansion Sample Setup** menu command. With the factory settings, these samples will not be available.
- With the factory settings, programs that use this PCM data are preloaded into a portion of the USER-A program bank.
- To use these samples, select Bank EXs2 (Stereo, Mono) for a program’s **“MS Select”** or a drum kit’s **“DS Select”** fields.

Note: If EXs2 is not loaded, the factory programs in bank User-A will not play correctly. For more information, see the Voice Name List (VNL).

User sampling RAM capacity

The OASYS comes with 1 GB of RAM pre-installed, which can be expanded up to 2 GB with a user-installable DIMM module. This memory is shared between the operating system, ROM and EXs samples, and RAM samples.

In particular, the size of the currently loaded EXs samples trades off against the memory available for RAM samples. The more space used by the EXs samples, the less is available for RAM samples, as shown below.

EXs samples and available sample RAM

EXs Loaded	Available Sample RAM	
	1GB installed	2GB Installed
None	500 MB	~ 1.5 GB
EXs1 ROM Expansion	187 MB	~ 1.2 GB
EXs2 Concert Grand Piano	0 MB	~ 1 GB

Note: To check the amount of sample RAM available, see “0–1f: Free Sample Memory/Locations” on page 572 of the Parameter Guide.

For more information, see “Sampling and RAM” on page 119, “Installing memory” on page 1038 of the Parameter Guide, and “Expansion Sample Setup” on page 684.

Selecting which EXs PCM data is loaded

You have the following possibilities for loading EXs PCM data at startup:

- ROM and EXs1 (factory setting)
- ROM and EXs2
- ROM, EXs1, and EXs2 (if memory has been expanded to at least 1.5 GB)
- ROM

1. Press the **MODE GLOBAL** switch to enter **Global mode**.
2. Press the **EXIT** switch to access the **P0: Basic Setup page**.
3. In the upper right of the LCD screen, press the **page menu button** and choose **“Expansion Sample Setup.”**

The Expansion Sample Setup dialog box will appear.

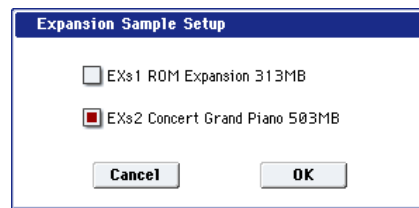

4. Check the desired PCM bank.

If “EXs1 ROM Expansion: 313 MB” is checked, the ROM and EXs1 multisamples/samples will be loaded at power-on.

If “EXs2 Concert Grand Piano: 503 MB” is checked, the ROM and EXs2 multisamples/samples will be loaded at power-on.

If neither is checked, only the ROM multisamples /samples will be loaded.

Note: To load both EXs1 and EXs2 at the same time, you must first expand the installed RAM to at least 1.5 GB. If you select both EXs1 and EXs2, but there is insufficient RAM, a “memory full” message will appear, and the operation will not be executed.

5. Press the **OK** button.

The following message will appear:

The Expansion Sample Setup has now been changed. In order for your changes to take effect, please turn the power off, and then on again.

[OK]

 This completes the Expansion Sample Setup operation. The next time you turn on the power, the specified PCM bank will be loaded and available.

6. Press the OK button.

7. Turn off the power.

The next time you turn on the power, the specified PCM bank will be loaded and available.

⚠ When you turn off the power, any data you had been editing will be lost. You must save your data before you turn off the power.

8. Wait about ten seconds, and then turn the power on again.

⚠ After turning the power off, you must wait ten seconds before you turn the power on again.

9. Select and play programs and combinations that use the loaded multisamples/samples.

For details, please refer to the tables below.

Program banks and PCM memory

Bank	Expansion Samples Required?
INT-A...D	No
INT-E	Requires EXs1
INT-F, USER-F	No
GM, g(1) ...g(9), g(d)	No
USER-A	Requires EXs2
USER-B...E, G	No

Combination banks and PCM memory

Bank	Expansion Samples Required?
INT-A, B	No
INT-C	Requires EXs1
INT-D...G USER-A...G	No

About polyphony

Most hardware synthesizers offer a single, fixed method of synthesis, a predetermined number of voices, and a fixed amount of effects processing power. OASYS is different; it has no fixed synthesis method, and it shares its processing power between voices and effects.

This flexibility means that the system can deliver power where you need it the most. For instance, one Program may need a bunch of voices layered together, but not many effects; another might need complex effects processing, but not as many voices. In both cases, OASYS will automatically divide its processing power appropriately.

Unlike most computer-based systems, OASYS also monitors the overall processing power, reducing the overall number of voices if necessary, to make sure that there are never problems with the audio.

Normally, you shouldn't need to think about this at all; it will just happen automatically. Sometimes, however, it can be convenient to know how the system is allocating its resources. The Effect/EXi Resource Meter, shown on the P8: Insert Effect– Insert FX, Track View and P9: Master Effect– Routing pages of each mode, provides this information.

Effect/EXi Fixed Resource Meter

The resource meter shows how the OASYS processing power is being used, as an approximate percentage of the total available power. There are three main categories: FX, EXi Fixed, and Free for Voices.

Note: the displayed values are rounded to the closest 1%, but the internal values have a much finer resolution. This means that you may sometimes add an effect, but see no change in the resource meter.

FX

This shows the percentage of the total processing power being used for the IFX, MFX, and TFX. This will vary depending on the specific effects being used.

If an effect has been assigned to an IFX, MFX, or TFX, it will take up the same amount of processing resources even if it is turned Off or bypassed. If you want to free up the processing resources, change the selection to 000: No Effect.

EXi FIXED

This shows the percentage of the total processing power used for the fixed components of EXi instruments. "Fixed" means that part of the EXi starts using processing power as soon as the EXi is loaded, before playing any notes; this includes the built-in effects of the CX-3, for example.

Only some EXi include fixed components; for instance, the CX-3 does, but the AL-1 does not. For information on other EXi, see their individual documentation.

For more information on EXi fixed resources, please see "CX-3 & STR-1: Limitations on EXi fixed resources" on page 326.

FREE FOR VOICES

This shows the percentage of the total processing power remaining after the FX and EXi fixed components. This power is available for playing synthesizer voices.

When Free for Voices is at 100%, you can achieve the maximum polyphony—for instance, 172 voices of the HD-1, 96 voices of the AL-1, or 172 voices of the CX-3. When more effects or EXi fixed resources are being used, polyphony will be reduced accordingly.

Note: As with the meter as a whole, the number shown in **FREE FOR VOICES** is only an approximation. For example, if **FREE FOR VOICES** is showing 98, the maximum polyphony for the HD-1 may not be exactly 172×0.98 (approximately 168).

The maximum polyphony may also depend on various other parameters; for more information, see “A note about polyphony” on page 32 of the Parameter Guide.

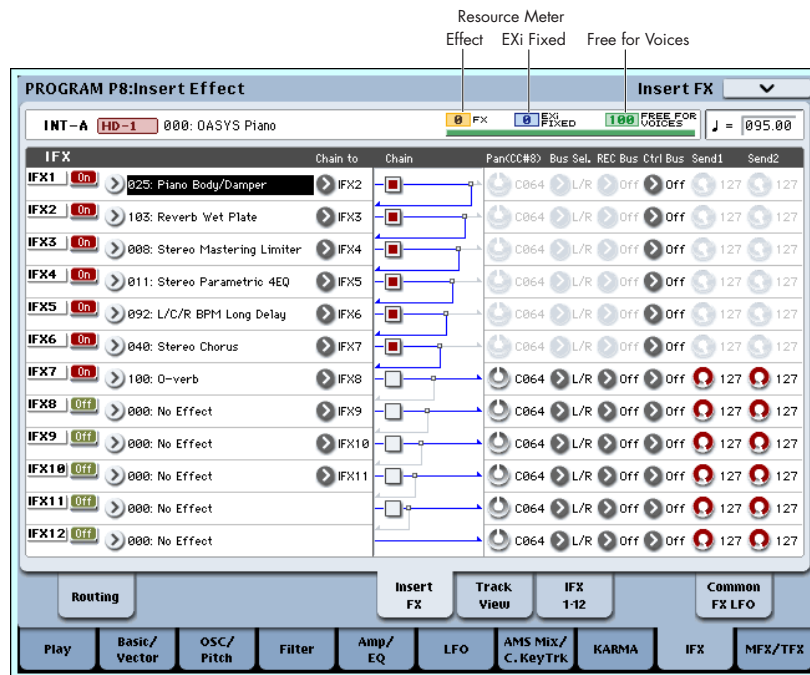

Basic operations

After you’ve turned on the OASYS, here’s how to perform basic operations such as selecting modes and pages.

1. Selecting modes

In order to use a particular function on the OASYS, you must first select the appropriate mode.

Press one of the front panel mode buttons (**COMBI**, **PROGRAM**, **SEQ**, **SAMPLING**, **GLOBAL**, or **DISK**) to enter the corresponding mode.

- COMBI switch: Combination mode
- PROGRAM switch: Program mode
- SEQ switch: Sequencer mode
- SAMPLING switch: Sampling mode
- GLOBAL switch: Global mode
- DISK switch: Disk mode

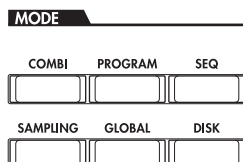

2. Selecting pages

Each mode has a large number of parameters, which are grouped into pages. These are further subdivided by tabs into up to nine tab pages.

1. Make sure that the desired mode is selected.

To select a mode, press the appropriate mode key (COMBI switch – DISK switch).

Here we will use Program mode as an example for our explanation. Press the PROGRAM switch.

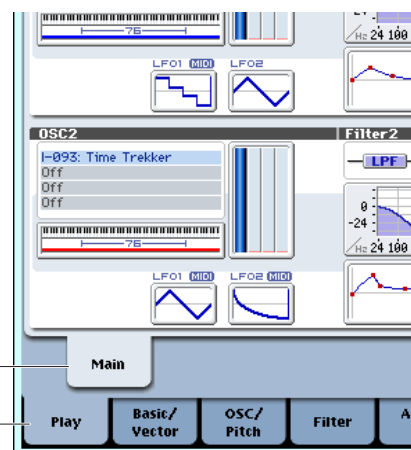

2. Press a tab in the lower line (page group tabs).

As an example here, press the Basic/Vector tab. The current page indication in the upper left of the LCD screen will indicate “PROGRAM P1: Basic/Vector,” and the page group will change.

When you press the EXIT switch, you will return to P0 from any page.

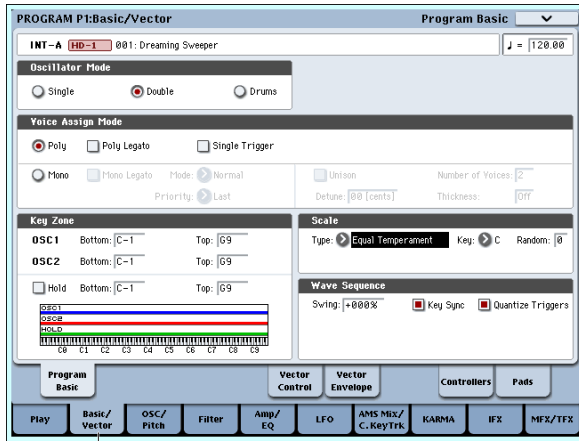

Basic Vector tab

3. Press a tab in the upper line (page tabs) to select a page.

As an example here, press the Vector Control tab. The current page indication in the upper left of the LCD screen will stay the same, but the upper right indication will change to "Vector Control." You've selected the Vector Control page.

Note: Some pages have no tabs.

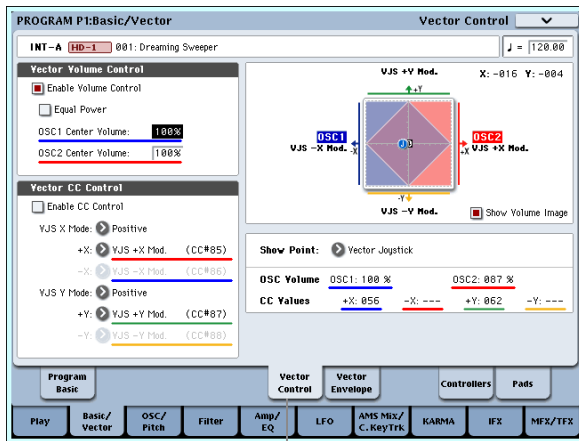

Vector Control tab

3. Editing parameters

The parameter value in the edit cell can be set by using the front panel VALUE controllers (VALUE slider, Δ/∇ switches, VALUE dial, numeric keys 0–9, – switch, ENTER switch, and (.) switch). As necessary, you can also use the BANK switches and the COMPARE switch.

For some parameters, you can use the BANK SELECT switches to select the bank of a program etc., or press a popup button to access a popup menu where you can specify the value of the parameter. In some cases, you can hold down the ENTER switch and play a note on the keyboard to specify a note or a velocity value.

VALUE entry

VALUE slider

Use this when you wish to make major changes in the value.

In Program mode and Combination mode, this slider can also be used as a control source for alternate modulation or dynamic modulation. (This is active in Program or Combination P0: Play when the "Program Select" or "Combination Select" (the large characters in the upper part of the LCD) is selected).

Δ/∇ switches

Use these when you wish to make small changes in the value.

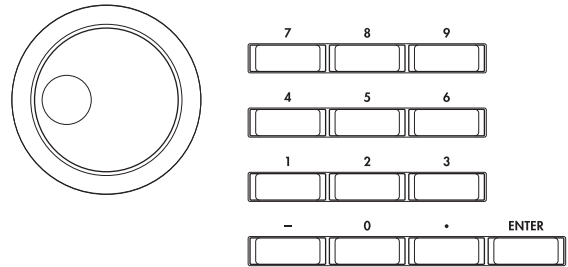

VALUE dial

Use this when you wish to make large changes in a value.

Numeric keys 0–9, ENTER switch, – switch, (.) switch

Use these when you know the parameter value that you wish to input.

After using the numeric keys 0–9 to input a number, press the ENTER switch to finalize the parameter value.

Use the – switch to enter negative numbers.

Use the (.) switch to enter a decimal point.

BANK INT-A-G, USER-A-G switches

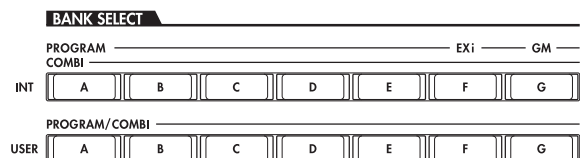

The BANK INT-A-G, USER-A-G switches are used in Program mode to select the program bank and in Combination mode to select the combination bank. In combination, and Sequencer modes, these switches are used to select the bank of the program used by each timbre/track.

COMPARE switch

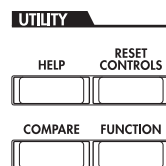

Use this when you wish to compare the edits you have made to a program or combination's sound with the un-edited original (i.e., the sound that is written into memory).

When editing a program or combination, press this switch. The LED will light, and the last-written settings for that program number or combination number will

be recalled. When you press the COMPARE switch once again, the LED will go dark and you will return to the settings that you were editing.

If you edit the settings that are recalled by pressing the COMPARE switch (i.e., the settings that are written into memory), the LED will go dark, and it will not be possible to return to the previous edits by pressing the COMPARE switch again.

In Sequencer mode, you can use the COMPARE switch to make “before and after” comparisons immediately after using realtime recording or step recording to record a song, or after performing a track edit operation.

For example, this can be used effectively when realtime-recording a track for a song.

- 1. Realtime-record a MIDI track. (Take 1)**
- 2. Once again, realtime-record on the same track. (Take 2)**
- 3. Press the COMPARE switch. The LED will light, and take 1 will be recalled.**
- 4. Press the COMPARE switch once again. The LED will go dark, and take 2 will be recalled.**
- 5. If at step 3 you once again realtime-record on the same track (take 3), the object of the Compare function will now be take 1.**

If at step 4 you once again realtime-record on the same track (take 3), the object of the Compare function will be take 2.

In this way, the Compare function lets you recall the previous recording or the previous state of event editing.

The Compare function does not work in Global mode, with the exception of Sampling, Disk, Wave Sequence, and Drum Kit editing.

Popup buttons and popup menus

You can press a popup button to access a popup menu, and then set parameter values.

Keyboard input

When entering a note number or a specific velocity as the value of a parameter, you can use the keyboard to input the setting. Hold down the ENTER switch and play the note that you wish to enter as a value. The note number or velocity value will be input.

When the Global P5: Drum Kit page is displayed, you can hold down the ENTER switch and play a note to recall the settings that have been assigned to that note. (If the parameter you’ve selected expects you to enter a velocity value, the velocity you played will be entered.)

In Sampling mode, you can hold down the ENTER switch and play a note to recall the index that is assigned to that note.

Setup

Connections

⚠ Connections must be made with the power turned off. Please be aware that careless operation may damage your speaker system or cause malfunctions.

3. Analog audio input connections

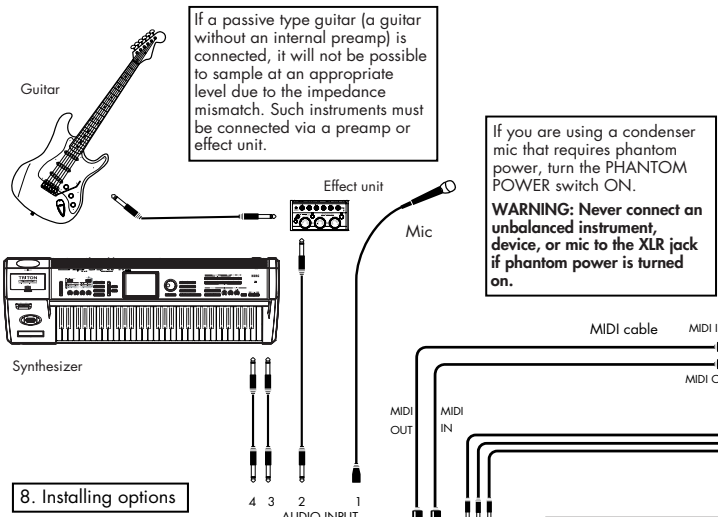

7. Connections to MIDI equipment/computers

5. Pedal connections etc.

8. Installing options

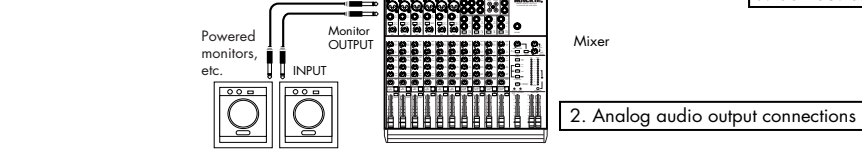
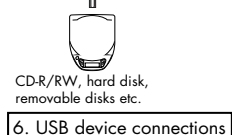
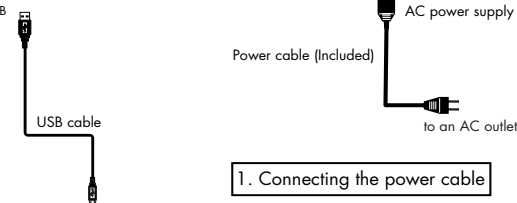
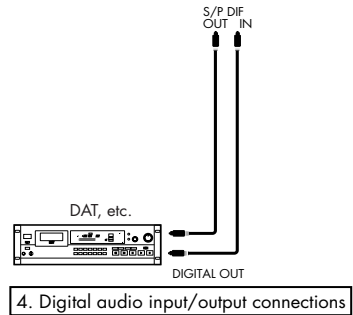

1. Connecting the power cable

1. Turn off the power of the OASYS.
 2. First connect the included power cable to the OASYS' rear panel AC power inlet.
- ⚠ If your power cable uses a separate ground wire, you must connect this ground wire before inserting the plug into the AC outlet. When disconnecting, you must first disconnect the plug before you disconnect the ground wire. If you are unsure of how to make connections, please contact Korg customer service.

⚠ Make sure that your AC outlet is the correct voltage for your instrument.

2. Analog audio output connections

- Here's how to connect the OASYS to your analog amp or mixer.
- ⚠ If you've connected a stereo audio amp, be aware that playing at high volume may damage your speaker system. Be careful not to raise the volume excessively.

AUDIO OUTPUT (MAIN) L/MONO and R

These are the main outputs, accessed by setting **Bus Select** to L/R. All of the factory sounds use these outputs, and the Master and Total Effects are always routed here as well.

1. Connect the AUDIO OUTPUT (MAIN) L/MONO and R outputs to the inputs of your amp or mixer.

If you're using OASYS in stereo, use both the (MAIN) L/MONO and R jacks. If you're using OASYS in mono, use only the (MAIN) L/MONO jack.

2. Use the VOLUME slider to adjust the volume.

The VOLUME slider affects only the main stereo outputs and the headphones; it does not affect the individual outputs, the S/P DIF output, or the optional ADAT outputs.

AUDIO OUTPUT (INDIVIDUAL) 1–8

These are 8 additional analog outputs, which can be used as individual mono outputs, stereo pairs, or any combination of the two. Signals sent to these outputs are also mirrored on the ADAT outputs of the optional EXB-DI, if installed. Almost any signal source can be routed to these outputs, including:

- Each note in a Drum Kit
- Insert Effect outputs
- Each Program in a Combination or Song
- Audio tracks
- Audio inputs

You can use these to isolate or group together sounds for recording, or for complex live performance setups.

1. **Connect the (INDIVIDUAL) 1-8 outputs to the your amp or mixer inputs.**
2. **Use the Bus Select parameters to send the desired sounds, audio tracks, inputs, or effects to the individual outputs, as either mono (1...8) or stereo (1/2...7/8) signals.**

If the signal is going through one or more insert effects, the output is set at the last IFX in the chain, via the **Bus Select** parameter on the P8-5 Insert Effects page.

If a Program, Timbre, or Track is *not* going through any insert effects, the output is set using the **Bus Select** parameters on the P8-1 or 8-2 Routing page.

To assign audio inputs directly to outputs, use **Bus Select** parameters in the P0– Audio Input (Sampling) page.

In Global mode, the Audio page **L/R Bus Indiv. Assign** setting lets you mirror the MAIN stereo L/R output on any pair of individual outputs. You can use this to create a private monitoring setup in live and studio environments, or to send the main outputs to the optional EXB-DI's ADAT output. For more information, see "L/R Bus Indiv. Assign (Assign to L/R and Indiv.Out)" on page 649 of the Parameter Guide.

Note: You can't use the VOLUME slider to adjust the volume of the individual outputs.

Headphones

1. **If you're using headphones, connect them to the OASYS' headphone jack.**

2. **Use the VOLUME slide to adjust the volume of the headphones. The OASYS' headphone jack outputs the same signal as the (MAIN) L/MONO and R jacks.**

Tip: To monitor the (INDIVIDUAL) 1–8 signals, use an external mixer.

3. Analog audio input connections

Here's how to input external analog audio sources into the OASYS so that they can be sampled, recorded on the hard disk, or processed through the internal effects.

AUDIO INPUT 1, 2

These two inputs use combo-type jacks to accept either XLR or 1/4" TRS balanced connections. They also include preamps with adjustable gain, and optionally provide phantom power for condenser microphones. You can use these for:

- Balanced line-level signals, such as mixers, computers, other synthesizers, etc.
- Microphones, including phantom-powered condenser mics

1. **Connect your mics or the output jacks of your external audio sources to the INPUT 1 and 2 jacks.**
2. **Set the MIC/LINE switch as appropriate for the device you've connected, and use the LEVEL knob to adjust the gain.**

Choose the LINE setting (switch pressed inward) if you've connected a mixer, computer, audio system, signal processor, or another synthesizer.

Choose the MIC setting (switch in the outward position) if you've connected a mic. If you're using an XLR condenser mic that requires phantom power, turn the PHANTOM POWER switch on **after** connecting the microphone. Otherwise, leave this switch turned off.

 **IMPORTANT:** Never connect an unbalanced instrument, device, or mic to the XLR connector when phantom power is on.

3. **After turning on the power, use the Audio Input page to set up the volume, pan, bus routing, and send levels for the inputs, as desired.**

For more information, see "0–8: Audio Input/Sampling" on page 11 of the Parameter Guide.

AUDIO INPUT 3, 4

These are unbalanced 1/4" phone jacks, for line-level connections. If you need to connect microphones, electric guitars, or other lower-level signal sources, use inputs 1 and 2 instead.

1. **Connect the output jacks of your line-level instrument or equipment to the INPUT 3 and 4 jacks.**
2. **Adjust the output level on your external equipment.**
3. **After turning on the power, use the Audio Input page to set up the volume, pan, bus routing, and send levels for the inputs, as desired.**

For more information, see "0–8: Audio Input/Sampling" on page 11 of the Parameter Guide.

Note: Guitars with active pickups can be connected directly to any of the inputs. Guitars with passive pickups (i.e., guitars that do not have an internal preamp) can be used with inputs 1 and 2, but the impedance mismatch will cause both a change in tone and a reduction in volume. For best results, route such guitars through a pre-amp or effects unit before connecting them.

4. Digital audio input/output connections

Digital audio output

The same signal as the OASYS' AUDIO OUTPUT (MAIN) L/MONO and R jacks can be digitally output to an audio system, digital mixer, DAT or MD recorder, or other device that can accept a sampling rate of 48 kHz or 96 kHz.

- Use an optical cable to connect the S/P DIF OUT (MAIN) jack to the optical digital input jack of your device.

This will output the same audio signal as the AUDIO OUTPUT (MAIN) L/MONO and R jacks.

Note: You can't use the VOLUME slider to adjust the volume of the digital output.

Digital audio input

An audio system, digital mixer, DAT or MD recorder, or other device that can output audio at a sampling rate of 48 kHz or 96 kHz can be input to the OASYS' L and R channels, and recorded or sampled to the hard disk or routed through the internal effects and sent to the OUTPUT jacks.

1. Use an optical cable to connect the optical digital output of your DAT or other device to the S/P DIF IN jack of the OASYS.
2. After turning the power on, set the "S/P DIF Sample Rate" (Global P0: Global Setup– Basic Setup page). Incoming data at a 96 kHz sampling rate will be converted for 48 kHz for recording.
3. Set System Clock (Global P0: Global Setup– Basic Setup page) to S/P DIF.
4. After turning on the power, use the Audio Input page to set up the volume, pan, bus routing, and send levels for the inputs, as desired.

For more information, see "0–8: Audio Input/Sampling" on page 11 of the Parameter Guide.

You can use the S/P DIF inputs simultaneously with the four analog inputs.

5. Connecting Foot Pedals and Switches

Connecting a damper pedal

The damper pedal is also sometimes called the sustain pedal. It acts like the similarly-named pedal on an acoustic piano; when you hold down the pedal, notes will continue to sustain even when you lift your hands off of the keyboard.

1. Connect an optional DS-1H damper pedal to the DAMPER jack. If you've connected a DS-1H, you'll be able to obtain half-damper effects.

After turning the power on:

2. Go to the Global P2: Controllers/Scales page, and use the Damper Polarity parameter to set the damper polarity.
3. Go to the Global P0 page, and use the Half Damper Calibration menu command to adjust the sensitivity if desired.

For more information, see "Damper Pedal (Sustain)" on page 48, and "Damper Polarity" on page 659 of the Parameter Guide.

Connecting a foot switch

You can use a connected foot switch to perform functions such as controlling sostenuto, soft pedal on/off, KARMA function on/off, selecting programs or combinations, starting/stopping the sequencer, and controlling tap tempo.

1. Connect a foot switch such as the optional PS-1 to the ASSIGNABLE SWITCH jack.
2. After turning the power on, use Global P2: "Foot Switch Assign" and "Foot Switch Polarity" to assign the function controlled by the foot switch and to specify the polarity.

For more information, see "2–1a: Foot Switch & Pedal/Damper" on page 659 of the Parameter Guide.

Connecting a foot pedal

You can use a connected foot pedal to control volume, modulation, or other functions.

1. Connect an optional XVP-10 or EXP-2 etc. to the ASSIGNABLE PEDAL jacks.
2. After turning the power on, use Global P2: "Foot Pedal Assign" to assign the function controlled by the foot pedal.

For more information, see "Foot Pedal Assign" on page 659 of the Parameter Guide.

6. Connecting USB devices

OASYS supports high-speed USB 2.0 for connecting to storage devices, such as hard drives, flash media, and CD-R/RW drives. You can save and load samples, sounds, sequences, and other data to and from USB 2.0 devices, for backup, transferring to computers, etc.

Note that HDR tracks must be played from and recorded onto the internal hard drive. You can back them up to USB devices, however.

The maximum supported capacity depends upon the format of the USB device. With FAT16 format, the maximum capacity is 4 GB; with FAT32, the maximum is 2 Terabytes (2,000 GB).

1. Use a USB cable to connect your external USB device to one of the OASYS's USB ports.

Standard USB cables have a different connector at each end. Plug the flat, rectangular connector into the OASYS, and plug the square-ish connector into the external USB storage device.

Note: If the device you are using does not support hot-plugging, make connections with the device powered-off, and then turn on the power of your device.

2. Execute the Disk mode Utility menu command “Scan USB Device.”
3. Use the Disk mode Drive Select screen to check the connection.

For more information, see “Loading & saving data, and creating CDs” on page 163.

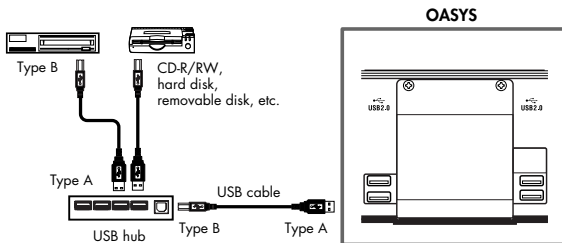

Hot-plugging

The OASYS supports USB hot-plugging. This means that you can connect or disconnect the USB cable while the power is on.

Note: In order to use hot-plugging, the USB device you are connecting must also support hot-plugging.

8 USB devices maximum

OASYS has four separate USB 2.0 ports, and can support up to 8 USB devices simultaneously. Note that it doesn't matter how the devices are connected; even if you use hubs or different ports, the maximum is always 8 devices.

USB Power

Some USB devices get their power from the USB connection. These are called “bus-powered” devices, and they are supported by OASYS.

Other USB devices may require a separate power source, in addition to the USB connection; in this case, you'll need to use an appropriate power adaptor for the device.

There is a limitation to the total current supplied to all connected USB devices, as defined by the USB specification. If the total current consumption of the connected devices exceeds this limit, the OASYS may not correctly recognize the connected USB devices. If this happens, an error message of “USB Hub Power Exceeded!” will appear.

Turning the power on/off

- ⚠ Before you turn on the power, make sure that the desired connections have been made as described in “Connections” on page 37.

1. Turning the power on

1. Press the rear panel POWER switch to turn on the power.

The LCD will show the model name, software version, and the amount of RAM memory.

Version: Indicates the system version of the OASYS. (The version may change without notice.)

Memory: Indicates the amount of RAM memory.

To avoid this problem, if you connect more than one USB device, please use a self-powered USB hub in self-powered mode. For details on connections and settings for your hub, please refer to its documentation.

For details on the electrical current used by a specific USB device, refer to its owner's manual.

7. Connections to MIDI equipment & computers

Connections to MIDI equipment

The keyboard, controllers, and sequencer etc. of OASYS can be used to control an external MIDI tone generator. Conversely, another MIDI keyboard or sequencer can control the tone generator of OASYS to produce sound.

- Use MIDI cables to connect the MIDI connectors of OASYS with the MIDI connectors of your external device.

For more information, see “Connecting MIDI devices & computers” on page 1001 of the Parameter Guide.

Connections to a computer

Your performance on the OASYS, as well as controller and sequencer data, can be sent to a computer (connected via MIDI interface), and the tone generator of OASYS can be played from the computer.

- Use a MIDI interface to connect the MIDI connectors of OASYS to the MIDI connectors of your computer.

For more information, see “Connecting MIDI devices & computers” on page 1001 of the Parameter Guide.

Note: Some USB-MIDI interfaces may not be able to transmit or receive the OASYS's MIDI System Exclusive messages.

8. Installing options

You can install the optional EXB-DI to add ADAT outputs and a Word Clock input. For details, see “EXB-DI (Digital interface board)” on page 1036 of the Parameter Guide.

Options: Indicates whether an EXB-DI is installed, and the currently-loaded status of EXs1 or EXs2.

Example: Factory settings

Version: V1.0.0

Memory: 1GB

Options: EXs1

Example: EXs2 is loaded

Options: EXs2

Example: EXB-DI is installed and EXs2 is loaded

Options: EXB-DI/EXs2

2. Turn on your powered monitors or stereo amp.

3. **Raise the OASYS's VOLUME slider to an appropriate level, and adjust the volume of your powered monitors or stereo amp.**

 After you've turned off the power, you must wait approximately ten seconds before turning the power on again.

Tip: You can set the "Power On Mode" (Global P0: System Preference page) so that the mode and page that had been selected when you turned the power off will appear when the power is turned on.

For more information, see "Recalling the last-selected mode and page at power-on" on page 148.

Leaving or deleting WAVE files in the TEMP folder

If you record audio tracks in Sequencer mode and then turn off the power without saving the song, the WAVE files will remain in the TEMP folder of the internal hard disk. If this occurs, the following dialog box will appear the next time you power-on, asking you whether you want to delete these WAVE files or save them:

There are un-saved audio files from your previous recording session.

Do you want to restore these files, or delete them from the disk?

[Restore] [Delete]

If you don't intend to use the WAVE files, we recommend that you delete them so they don't waste space on the internal hard disk. To delete them, press the Delete button.

If you want to use these files in a new song etc., press the Restore button to keep them.

For more information, see "How audio data is stored on the disk" on page 96.

LCD screen display when options are installed

If you install the EXB-DI option in the OASYS, the EXB-DI will be added to the indications in the "Options" area of the screen. After installing the EXB-DI, be sure to check this screen to see whether this

indication appears. If this indication does not appear even though you've installed the EXB-DI, it was not installed correctly. Turn off the power and reinstall the EXB-DI.

For details, see "Option boards/Memory/Calendar battery" on page 1035 of the Parameter Guide.

2. Turning the power off

1. **Set the front panel VOLUME slider and the volume of your powered monitor or stereo amp to zero.**
2. **Turn off the power of your powered monitor or stereo amp.**
3. **Press the OASYS's POWER switch to turn off the power.**

 Never turn off the power while data is being written into internal memory.

 While data is being written, the LCD screen will indicate "Now writing into internal memory." Data is written into internal memory by the following operations.

- Writing (updating) a Program, Combination, Global Setting, Drum Kits, or Wave Sequences
- Loading Program, Combination, Global Setting, Drum Kit, or Wave Sequences data in Disk mode
- Receiving a MIDI data dump for Program, Combination, Global Setting, Drum Kit, or Wave Sequences
- When using Sampling mode menu commands ("Move Sample," "Move MS," "Convert MS To Program," "Time Slice," etc.) to simultaneously modify programs or drum kits.
- When sampling to RAM in Program, Combination, or Sequencer mode, if you simultaneously convert the sample to a program.

 Never turn off the power while media such as the hard disk is being accessed, **such as while recording or playing audio tracks, or sampling for an extended time on the hard disk.** Turning off the power while disk access is occurring may render the media unusable.

Using the CD-R/RW drive

Inserting a disc

Make sure that the OASYS is on.

1. **Press the eject button of the CD-R/RW drive to open the disc tray.**

At this time, the tray will open only halfway. You must manually pull the tray out completely before placing a disc on it.

 When opening the CD-R/RW drive for the first time, remove the pickup stopper from the disc tray before using the drive.

2. **Place the disc accurately in the tray, label side up.**
3. **Push the disk tray in until it is completely closed.**

Removing a disc

1. **Press the eject button to open the disc tray.**

The tray will open about halfway. Manually pull the tray out far enough to remove the disc from the tray.

2. **Gently remove the disc from the disc tray.**
3. **Push the disc tray in until it is completely closed.**

Emergency disc removal

Normally you will be able to remove the disc as described above. However, if this is not possible due to a power failure or other problem, you can also remove the disc as follows.

Insert a pin-like object of less than 1 mm diameter, such as a straightened paper clip, into the manual eject pinhole and push. The disc tray will be forced open.

- ⚠ Excessive use of this method may cause the CD-R/RW drive to malfunction.
- ⚠ This procedure must be performed with the power off.

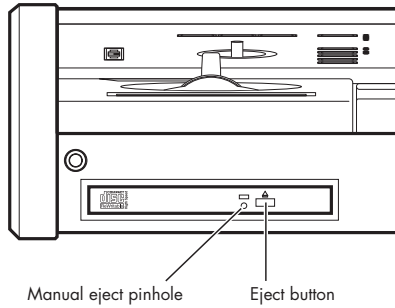

Playing and editing Programs

What's a Program?

Programs are the basic sounds of the OASYS. You can play them by themselves, layer them together in Combinations, or play a different Program on each of the 16 MIDI tracks, either from the internal sequencer or from external computer-based sequencers.

This section of the manual takes a quick look at playing Programs, including tours of the front-panel controllers and basic editing techniques.

Selecting Programs

There are several different ways to select Programs. Each one is convenient in a different way:

- Using the front-panel buttons, value slider, and value knob, you can select Programs quickly via physical controls
- Selecting by Bank and number (via the touch-screen) lets you browse through all of the Programs in memory, to find the one that you want
- Selecting by Program category (via the touch-screen) lets you filter Programs by sound type, such as Pianos or Drums
- Using a foot-switch lets you change Programs even while both hands are busy playing on the keyboard - convenient for live applications
- MIDI program change messages let you select Programs remotely, from either -a MIDI sequencer or an external MIDI controller

Overview: Program Banks

OASYS ships from the factory with over a thousand Programs loaded into memory. Another 768 Program slots are left open for your own programming, or additional sound libraries.

These Programs are organized into 14 Banks, as described below. You can also store many more Programs on the hard drive, or on external USB 2.0 devices.

The preloaded Programs in internal (INT) banks A-E use the HD-1 sample-playback synthesizer and the built-in sample library.

Both INT-F and USER-F are EXi banks. Their preloaded Programs use the AL-1 to create analog synth sounds, and the CX-3 to make tonewheel organ sounds.

Internal bank G contains a full set of General MIDI 2 Programs.

USER A-E and G are left open, and contain only initialized Programs. USER-B bank is the default location for Programs created by resampling.

Program Bank Contents

As shipped from the factory, the contents of the Program Banks are as follows:

Program bank contents

Bank	Contents	Bank Type.
INT-A...D	Factory Programs	HD-1
INT-E	Factory Programs; requires the EXs1 ROM Expansion PCM.	
INT-F	Factory EXi Programs.	EXi
GM (INT-G)	GM2 main programs	GM
g(1)...g(9)	GM2 variation programs	
g(d)	GM2 drum programs	
USER-A	000...007: Factory Programs; requires the EXs2 Concert Grand Piano PCM. 008, 11...127: Initialized programs.	Bank type can be set to either HD-1 or EXi
USER-B...E, G	Initialized HD-1 Programs.	
USER-F	Factory EXi Programs.	

For details on the factory Programs, please refer to the "Voice Name List" on page 1041 of the Parameter Guide.

Changing the Bank Type for USER-A...G

Banks can contain either HD-1 Programs or EXi Programs, but not both. This assignment is fixed for the Internal banks, but can be set separately for each of the USER banks.

To change the type of a USER bank:

1. Press the front-panel GLOBAL button to enter Global mode.
2. Select the Basic tab.
3. Press the page menu button, and select Set Program User-Bank Type.
4. Change the Type for the desired banks. Leave all of the other banks set to "No Change."

Setting a bank's type will erase all of the Program data in the bank - so make sure that you're not erasing any Programs you want to keep!

5. Press the OK button.

An "are you sure?" dialog appears.

6. If you're certain of the change, press OK again.

The selected banks will now be initialized to use the new Program types.

Using the front-panel buttons

1. Make sure that the PROGRAM button, under MODE, is lit.

This means that you're in Program mode, in which you can select and edit Programs. If the button isn't lit, press it now; it will light up, and the main Program Play page will appear.

2. If you're already in Program mode, go to the main Program Play page.

The main Play page shows an overview of the sound structure, such as oscillators, filters, etc.

3. Make sure that the Program name is selected.

If it is not selected, go to the PROGRAM P0: Play page and touch the Program's name, so that it's highlighted.

4. Use the VALUE controllers to select the program number that you wish to play.

You can use the following methods to select a program.

- Turn the Value dial.
- Press the Inc Δ or Dec ∇ buttons.
- Use the numeric keypad [0]–[9] to specify the number, and press the ENTER key.

5. Press a BANK button (INT or USER A-G) to switch banks.

When you select a different Bank, the button's LED will light, and the selected bank will appear on the upper left side of the LCD screen.

For example, to select bank INT-B, press the B button in the top row of Bank buttons. The B button will light, and the name INT-B will appear in the upper left of the LCD screen.

Selecting by Bank and number

You can select Programs from a list organized by Program bank.

1. Press the Program Select popup button.

The Bank/Program Select dialog appears.

Bank/Program Select menu



In this illustration, bank A is selected. The list on the right shows the Programs contained in that bank.

2. Press the tabs on the left side of the display to select a bank.

3. Press one of the Program names in the list to select a Program.

The selected Program will be highlighted, and the keyboard will immediately switch to the new sound.

4. If you like, play a few notes to hear the new Program.

You can play the new Program while the menu is still showing, without needing to press OK.

5. When you are satisfied with the selected Program, press the OK button to close the popup menu.

If you press the Cancel button, the selection you made here will be discarded, and you will return to the program that had been selected before you opened the menu.

Selecting by Category

You can select Programs from within a category, such as keyboard, organ, bass, and drums. When shipped from the factory, the preloaded Programs are organized into 16 categories, each with several sub-categories. There are also 2 more categories, initially named User 16 and User 17, which you can use and rename as desired.

1. Press the Category popup button.

The Category/Program Select dialog appears.

Category/Program Select menu

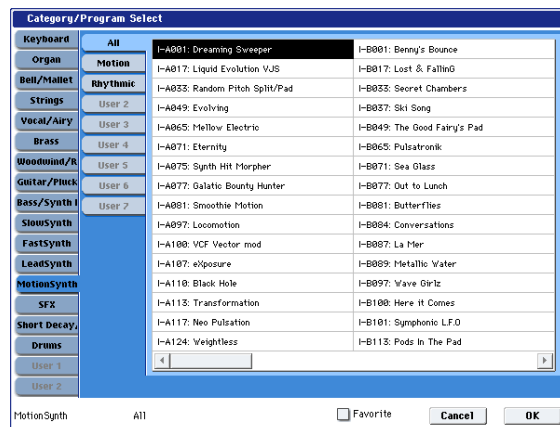

In the illustration above, the Motion Synth category is selected. The list on the right shows the Programs which belong to that category.

2. Press the tabs located to the left side of the display to select a different category.

The name of the selected category will be displayed in full in the lower left.

3. Press one of the program names in the center area to select a program.

The selected program will be highlighted.

4. When you are satisfied with the selected program, press the OK button to close the popup menu.

If you press the Cancel button, your selection will be discarded, and you will return to the program that had been selected when you opened the popup menu.

Using a footswitch to select Programs

You can assign a footswitch to step through Programs one by one, either going up (0, 1, 2, 3, etc.) or going down (3, 2, 1 etc.). This lets you change Programs without using your hands—great for quick Program changes in live performance situations.

There are two ways of doing this: by assigning the footswitch to Program Up/Down, or to Value Inc/Dec. Each of these is suited to a particular application, as described below.

Assigning the footswitch to Program Up/Down

Assigning the footswitch to Program Up or Program Down lets you directly control Program changes from the footswitch. For most situations, this is the more straightforward method.

To set this up:

1. Connect a foot switch to the rear-panel **ASSIGNABLE SWITCH** input.

Use a simple on/off footswitch, such as the optional KORG PS-1

2. Press the **GLOBAL** button to enter Global mode.
3. Go to the **Controller** tab of the **Controllers/Scales** page.
4. Set the **Foot Switch Polarity** parameter to match the connected switch.
5. At the top of the page, set the **Foot Switch Assign** parameter to **Program Up** (or **Program Down**).

Now, the foot switch will step through the Programs, one by one.

Note: This setting applies to selecting Combinations, as well.

Assigning the footswitch to Value Inc/Dec

This lets you use the Assignable Foot Switch to duplicate the functions of the front-panel Inc Δ or Dec ∇ buttons.

This may be particularly convenient if you like to keep the Bank or Category select windows open as you play, so that you can see the list of available Programs or Combinations. In this specific case, the Program

Up/Down assignments will not work (since Program changes are ignored while the window is open). However, assigning the Foot Switch to the Inc or Dec button lets you step through the items in the list, one by one—just like pressing the front-panel buttons.

To set this up:

1. Follow steps 1-4 under “Assigning the footswitch to Program Up/Down,” above.
2. At the top of the page, set the **Foot Switch Assign** parameter to **Value Inc** (or **Value Dec**).

Now, the foot switch will act just like pressing the front-panel Inc or Dec button.

Note: The footswitch will work like this for the entire OASYS—not just when the Program or Combination Select window is open.

Using MIDI Program Change

You can send MIDI Program Change messages to OASYS from external MIDI devices, such as computer sequencers or other MIDI controllers. In conjunction with MIDI Bank Select, you can use these to select any Program from all 14 Banks.

For more information, see “Bank Map,” on page 643 of the Parameter Guide.

In Program mode, use the Global MIDI Channel

All transmission and reception of MIDI data in Program mode is performed on the **Global MIDI Channel**. You can set this in Global mode, on the MIDI page.

General MIDI Programs

Internal bank G contains a full set of General MIDI 2 Programs, as well as sub-banks g(1)–g(9) (GM2 variation programs), and bank g(d) (drums).

When you select Programs using the Bank or Category windows, you’ll notice that a **Variation** button appears when you select bank INT-G. Each time you press this button, or repeatedly press the front-panel INT-G button, you’ll step through the General MIDI banks in the following order: G→g(1)→g(2)…g(8)→g(9)→G…

Using Controllers

The OASYS provides a lot of hands-on ways to control the sound—the mod and pitch-bend joystick, the Vector joystick, the ribbon controller, two switches (SW1 and SW2), and the Control Surface knobs, sliders, and switches.

These controls let you modify the tone, pitch, volume, effects, etc. in realtime while you play.

Joystick

The joystick moves in four directions: left, right, forwards (away from yourself), and backwards (towards yourself). Each of the four directions can be used to control a different function, such as

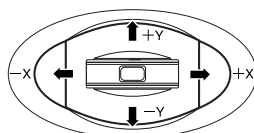

modulating Program or effects parameters. These assignments can be different for every Program, but generally, they do the following:

Standard Joystick functions

Move the joystick...	Controller Name	Normally controls...
Left	JS-X	Pitch bend down
Right	JS+X	Pitch bend up
Forwards (away from yourself)	JS+Y	Vibrato
Backwards (towards yourself)	JS-Y	Filter LFO (wah)

Joystick Lock

The joystick is spring-loaded, so that it automatically returns to the center position when you let go.

However, you can use either of the two front-panel switches (SW1 or SW2), or a foot-switch, to “lock” the current position of the joystick. This leaves your hands free to play on the keyboard, or to use other controllers. For more information, please see “Using the Lock function” on page 46.

Vector Joystick

VECTOR JOYSTICK

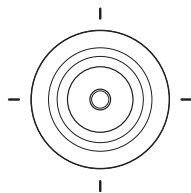

The Vector Joystick lets you control the volume balance between OSC1 and OSC2, and can also generate CC messages to modulate Program and effects parameters.

In Combi and Sequence modes, the Vector Joystick can do all of this, plus balance the volumes of the different Programs in the Combi.

The Vector Joystick does all of this in conjunction with the Vector Envelope, which is a flexible, multi-segment envelope with a few interesting twists. For more information, see “Using Vector Synthesis” on page 64.

Resetting the Vector Joystick to the center

You can use the front-panel RESET CONTROLS button to reset the Vector Joystick to its default center position. To do this:

1. Hold down the RESET CONTROLS button.
2. While holding RESET CONTROLS, move the Vector Joystick.
3. Release the RESET CONTROLS button.

The joystick will now be reset to its center position.

Ribbon Controller

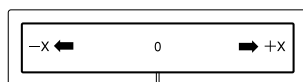

Move your finger to the left and right on the ribbon controller to apply an effect.

Normally, this is used to control pitch, volume or filter etc.

You can use the Lock function of SW1 or SW2 keys to hold the effect even after you release your finger from the ribbon controller. For more details, see “Using the Lock function” on page 46.

SW1, SW2

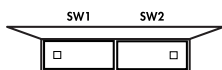

You can use these buttons to control program parameters via AMS (Alternate Modulation), or effect parameters via DMod (Dynamic Modulation).

They can also transpose the keyboard by octaves, turn portamento on/off, or lock the position of the ribbon controller, joystick, or aftertouch.

Each button can work as either a **Toggle** or **Momentary** switch. In **Toggle** mode, the assigned function is switched between on and off each time the key is pressed. In **Momentary** mode, the assigned function is active on only as long as you hold down the switch.

In Program mode, you can check the assignments of SW1 and SW2 on the Play page Assignment tab.

When you write a Program or Combination, the on/off status of the SW1 and SW2 keys is saved.

For more details, please see “Setting the functions of SW1 and SW2” on page 180.

Using the Lock function

Locking the Joystick

1. Using the standard factory sounds, select Program INT-A016: Real Suit E.Piano, and play the keyboard.

To select a program, make sure that you are in Program mode, and press the BANK INT A button, numeric key 1, 6, and then the ENTER key.

2. Move the joystick away from yourself (the +Y direction).

The vibrato effect will deepen.

3. While holding the joystick away from yourself, press the SW2 switch.

When you press the switch, its LED will light up, and the modulation effect at this point will be maintained.

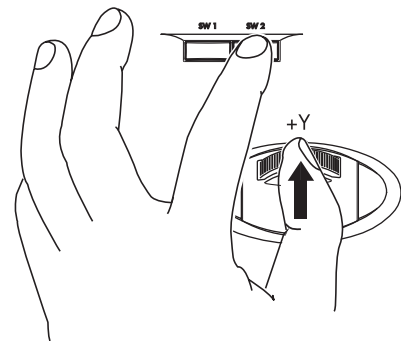

4. Release the joystick, and play the keyboard.

The modulation will stay the same as it was when SW2 was pressed. Moving the joystick away from yourself will not affect the sound.

5. Press the SW2 key once again to release the Lock function.

Locking the Ribbon Controller

Make sure that the INT-A016: Real Suit E.Piano program is selected.

1. Press the SW2 key.

The LED on SW2 will light up.

2. Touch the ribbon controller, and move your finger left and right.

Movement in the +X direction will brighten the tone, and movement in the -X direction will darken the tone.

3. Lift your finger up from the ribbon controller.

The sound will remain as it was when you last touched the ribbon.

4. Press the SW2 key once again to release the Lock function.
5. Press the tab labeled Cntrl/View Effect, to go to the Controller/View Effect page.

In the upper right-hand portion of the screen, notice that SW2 is assigned to **JS Y & Ribbon Lock**, and is set to **Toggle**. This means that SW2 is assigned to control the Lock function for both the joystick's Y axis and the ribbon controller. Many Programs and Combinations use this assignment.

You can also lock both the ribbon and the joystick at the same time:

1. Move the joystick in the +Y direction
2. Press the SW2 key to turn on the Lock function.
3. Move your finger on the ribbon controller.
4. Release the joystick, and lift your finger up from the ribbon.

The effects of both the ribbon and the joystick will be maintained until you press SW2 again to release the lock.

Lock can also be applied to aftertouch, by assigning SW1 or SW2 to **After Touch Lock**.

For details on the functions that you can assign to SW1 and SW2, please see the "SW1/2 Assignments," on page 979 of the Parameter Guide.

Control Surface knobs, sliders, & switches

The Control Surface has 8 knobs, 8 sliders plus a master slider, and 16 switches. You can use these for many different tasks:

- Controlling mixer features, including volume, pan, EQ, FX sends, mute, and solo
- Modulating and editing sounds
- Controlling KARMA
- Controlling external MIDI devices

You can switch the Control Surface between its different functions using either the on-screen tabs on the Control Surface page, or the front-panel Control Assign switches. The tabs and the front-panel switches mirror one another; when you change one of them, the other changes as well.

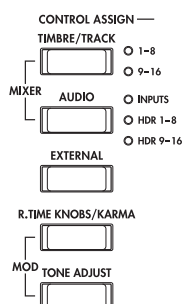

In Program mode, you can select one of five different functions:

TIMBRE/TRACK lets you adjust the volume, pan, and send levels for Oscillators 1 and 2, along with the Program EQ. In Combi and Sequence modes, you can also use this to select two different banks of Timbres or Tracks, as shown by the LEDs to the right of the switch.

AUDIO INPUTS lets you adjust the volume, pan, and send levels for the analog and S/P DIF audio inputs. In Sequence mode, you can also use this to select two banks of hard-disk recording tracks, as shown by the LEDs to the right of the switch.

EXTERNAL lets you send MIDI messages to external MIDI devices.

R.TIME KNOBS/KARMA lets you modulate sounds and effects with the knobs, and control KARMA with the sliders and switches.

TONE ADJUST gives you hands-on access to sound editing, using the sliders, knobs, and switches.

You can freely change back and forth between the different functions, without losing any of your edits.

Resetting controls to their saved values

The front-panel **RESET CONTROLS** button lets you recall the stored settings for any slider, knob, or switch on the control surface.

To reset a single knob, slider, or switch:

1. Hold down the **RESET CONTROLS** button.
2. While holding down **RESET CONTROLS**, move a slider or knob, or press one of the control surface buttons.

The slider, knob, or switch will be reset to the value stored in the Program.

3. When you're done, release the **RESET CONTROLS** button.

To reset a group of controls at once:

1. Hold down the **RESET CONTROLS** button.
2. While holding down **RESET CONTROLS**, touch any of the **Control Assign** buttons, such as **TIMBRE/TRACK** or **TONE ADJUST**.

All of the sliders, knobs, and switches in the Control Assign group will be reset to the values stored in the Program.

You can also reset all of the faders and switches in the KARMA module, by holding **RESET CONTROLS** and then pressing the **KARMA MODULE CONTROL** button. Similarly, to reset a single KARMA Scene, hold **RESET CONTROLS** and press any of the **SCENE** buttons.

Finally, you can also use this to clear all solos, by holding **RESET CONTROLS** and then pressing the **SOLO** button.

VALUE slider

When a program number is selected in Program P0: Play page, or when a combination number is selected in Combination mode page P0: Play page, you can use the VALUE slider to modulate Program and effects parameters.

Keyboard

Velocity

Velocity is a measure of how hard you play a note on the keyboard. This can be used to modulate many different aspects of the sound, such as volume, brightness, or the character of the attack.

After Touch

The keyboard can also measure how hard you press down after you play a note—hence the term “after touch.” You can use this to shape notes over time, controlling (for instance) volume or vibrato amount.

Note Number

Sounds can be programmed to change in character based on the note being played. As you play higher or lower on the keyboard, the note number can modulate the timbre—such as becoming brighter as you play higher. Envelopes may also become faster or slower; the volume may change; and so on.

Foot Pedals and Switches

Damper Pedal (Sustain)

The damper pedal is also sometimes called the sustain pedal. It acts like the similarly-named pedal on an acoustic piano; when you hold down the pedal, notes will continue to sustain even when you lift your hands off of the keyboard.

Damper Switch vs. Half-Damper

You can use either a standard footswitch (such as the Korg PS-1) or a special half-damper pedal (such as the Korg DS-1H) as the Damper.

If you use a footswitch, it will work like a normal synthesizer sustain pedal: notes will sustain forever, as long as the pedal is held down.

A half-damper pedal is a special type of continuous foot pedal (normal foot pedals won't work properly for this application). It offers more subtle control of sustain, which can be especially useful for piano sounds.

The off and full-on positions of the half-damper work just like the footswitch, but intermediate positions modulate the release time to increase sustain without making it infinite.

The OASYS will automatically sense when a half-damper is connected to the rear-panel DAMPER input. For proper operation, you will also need to calibrate the pedal, using the Calibrate Half-Damper command in the Global page menu.

Damper and MIDI

The Damper Pedal is sent and received as MIDI CC #64. In Combi and Sequence modes, you can “filter” CC# 64 so that it only affects some of the sounds in the Combi or Song.

Assignable Foot Switch

This lets you use a simple footswitch, such as the Korg PS-1, as an assignable controller. The footswitch can perform a wide variety of functions, such as:

- An assignable source for modulating sounds and effects
- Portamento on/off
- Program select up or down
- Sequencer start/stop or punch in/out
- Tap Tempo
- KARMA on/off, Latch on/off, or Scene select
- Duplication of many front panel controls, including the modulation joystick, ribbon, value slider, Real-Time Knobs, SW 1/2, the drum pads, KARMA sliders, or KARMA switches

The switch's function is set in Global mode (on the Controller tab of the Controllers/Scales page), so that it always works the same regardless of the current Program, Combi, or Song.

For more information, please see “Specifying the function of the ASSIGNABLE Switch and ASSIGNABLE Pedal” on page 149.

Assignable Foot Pedal

This lets you use a continuous controller pedal, such as the Korg EXP-2 foot controller or Korg XVP-10 EXP/VOL pedal, as an assignable controller.

Like the Assignable Foot Switch, described above, the Foot Pedal can be used for many different functions, including:

- Master Volume
- Channel Volume, Pan, or Expression
- Assignable sound modulation, as several different AMS or Dmod sources
- Effects Send level control
- Duplication of many front panel controls, including the modulation joystick, ribbon, value slider, Real-Time Knobs, or KARMA sliders

The pedal's function is set globally (on the Controller tab of the Controllers/Scales page), so that it always works the same regardless of the current Program, Combi, or Song. For more information, please see “Specifying the function of the ASSIGNABLE Switch and ASSIGNABLE Pedal” on page 149.

Drum & Chord Pads

There are eight velocity-sensitive trigger pads below the LCD screen. These look like drum machine pads, and playing drum sounds is certainly one use for them.

However, they can also play up to eight-note chords on any sound—not just drums. The pads even remember the velocities of the individual notes within the chord, as well as the notes themselves.

In addition to playing sounds directly, the pads are also used to select chords for Chord mode. For more information, see “Using Chord mode” on page 49.

Assigning notes and chords to pads

You can assign single notes and chords to the pads in three different ways.

Play the notes, and then press CHORD ASSIGN

1. Play a single note, or a chord of up to 8 notes.
2. Press the CHORD ASSIGN button.
3. Press the pad to which you'd like to assign the notes.

That's it! The notes are now assigned to the pad.

Press CHORD ASSIGN, and then play notes

This method lets you create a chord out of widely-spaced notes, even if you can't play all of the notes simultaneously.

1. Press the CHORD ASSIGN button.
2. Play a single note, or a chord of up to 8 notes.

You can play a single note, or a simple chord.

If you like, you can also play up to 8 notes as a legato phrase. As long as you take care that the notes overlap each other, the entire phrase will be recorded as a single chord. You can take as long as you like to play the phrase.

3. Press the pad to which you'd like to assign the notes.

After pressing the pad, you're done!

Editing notes and velocities using the LCD

You can edit the recorded notes and velocities using the LCD. If you like, you can also enter new notes this way. For more information, please see "1-9: Set Up Pads" on page 46.

Copying and merging pads

Copying one pad to another, or merging two or more pads together, is just like assigning notes from the keyboard.

As with assigning notes to the keyboard, you can either play the pads first, or press CHORD ASSIGN first. In the interest of saving space and time, only the first method is described below.

Copying notes from one pad to another

To copy the note assignments from one pad to another:

1. Press and release the pad whose notes you want to copy.
2. Press the CHORD ASSIGN button.
3. Press the pad to which you'd like to copy the notes.

The new pad will now play the same notes as the original pad.

Merging two or more pads together

You can merge the assignments from two or more pads together, as long as the total number of notes is 8 or fewer. To do so:

1. Press all of the pads that you'd like to merge, and then release them.
2. Press the CHORD ASSIGN button.
3. Press the pad to which you'd like to copy the notes.

All of the pads must be held down at the same time.

2. Press the CHORD ASSIGN button.

3. Press the pad to which you'd like to copy the notes.

You can even use one of the pads that was being merged, if you like. After pressing the destination pad, you're done.

Fixed Velocity vs. Velocity Sensitive

Each pad stores a velocity level for each of its 8 notes. The PAD MODE button, to the right of the pads, controls whether or not the pads respond to how hard you play.

In **Fixed Velocity** mode, the pads always use their stored velocity settings, regardless of how hard you play.

In **Velocity Sensitive** mode, hitting the pad very strongly produces the preset velocities. When you play more softly, the preset velocities are scaled down accordingly, maintaining the balance between the notes in the chord.

Using Chord mode

Overview

Chord mode lets you choose one of the chords assigned to the Pads, and then play it from the keyboard. The chord is transposed according to the note that you play; the played note specifies the lowest note of the chord, and the higher notes are transposed to match. As when playing chords from the Pads themselves, each note in the chord can have a different stored velocity, scaled by the played note.

In addition to using the on-screen parameters, you can turn Chord mode on and off via SW1/2 or the Foot Switch, and change chords simply by pressing the Pads. In Combination and Sequencer modes, you can

make these settings for each Timbre or Track, as desired. Naturally, you can control all of this via MIDI as well.

Chord mode can duplicate the way that similar features worked on classic analog synths (such as the original Polysix), but it can also use all of the Voice Assign options to create different effects—such as mono legato chords with fingered portamento, or poly chords that overlap one another.

Finally, note that you don't have to use Chord mode to play full chords; you can also use it to create more subtle effects, such as stacked octaves or fifths. You can even adjust the relative levels of these additional pitches via the stored velocities of the individual chord notes.

Chord Switch

The Chord Switch (abbreviated **Chord SW**) lets you turn Chord mode on and off via SW1/2 or the Foot Switch.

Important: Programs will only respond to the **Chord SW** if their Chord parameter has been set to either **Basic** or **Advanced**. If it's set to **Off**, then the switch will have no effect.

Assigning SW1/2 to control Chord on/off

Within any individual Program, Combi, or Song, you can set either SW1 or SW2 to turn Chord mode on and off. To do so:

1. In the Program, Combi, or Song, go to the Set Up Controllers page.
2. Select Chord SW as the assignment for SW1 or SW2.

Assigning the Foot Switch to control Chord on/off

You can also assign the Foot Switch to turn Chord mode on and off, so that you don't need to move your hands from the keyboard while performing. This setting will apply globally, regardless of the current Program, Combi, or Song. To do so:

1. Go to the Global Foot Switch Assign page.
2. Select Chord SW for the Assignable Foot Switch.

Enabling Chord mode

Program mode

To enable Chord mode for a Program:

1. Go to the Program Basic page
2. Set the Chord parameter to Basic or Advanced.

Once you've selected either **Basic** or **Advanced**, Chord mode is enabled immediately. Optionally, you can then turn Chord mode off and on via the **Chord SW**, using either SW1/2 or the Assignable Foot Switch.

If you set **Chord** to **Off**, then it will always remain off, regardless of the **Chord SW**. This is particularly useful in Combi and Sequencer modes, since it allows you to create splits and layers in which some Timbres/Tracks use Chord mode, but others do not.

Combination and Sequencer modes

To enable Chord mode for a Timbre in a Combi, or a track in a Song:

1. Go to page 2-2 OSC (under Timbre Parameters or Track Parameters, respectively).
2. Set the Timbre/Track's Chord parameter to Basic or Advanced.

Alternatively, you can set the Timbre/Track to **PRG**. This is the default, which uses the setting from the Program. Note that if the Program's Chord mode is set to **Off**, the Timbre/Track will not respond to the Chord Switch.

What if Timbres/Tracks share the same channel, but have different Chord settings?

If Timbres/Tracks share the same channel, but have different Chord settings, then the Chord SW affects each Timbre/Track individually, as below:

	Stored Setting		
	Off	Basic	Advanced
Chord SW = On	Off	Basic	Advanced
Chord SW = Off	Off	Off	Off

Example setup: keyboard split

To create a split with a single-note bass in the left hand, and a chord on the right:

1. Select a bass Program for Timbre 1, and a piano Program for Timbre 2.
2. Set Timbre 1's Chord to Off, and Timbre 2's Chord to Basic.

Now, the Chord SW will enable/disable the chord for the right hand only.

Details: initial state of Chord on/off

Normally, when you select a Program, Combi, or Song, Chord mode will be on or off as set by the **Chord** parameter.

The exception is when SW1 or SW2 is assigned to the Chord Switch. In this case, the stored on/off state of SW1/2 controls whether Chord mode will be on or off by default.

Note that this default state is slightly more complex in Combination and Sequencer modes:

- In Combination mode, SW1/2 affect only Timbres on the Global channel. Other tracks will be as set by their Chord parameters.
- In Sequencer mode, SW1/2 affect only the Tracks on the same channel as the current Keyboard Track. This determines the initial state when a Song is first selected, since the current Keyboard Track is stored with the Song. Other tracks will be as set by their Chord parameters.

Basic and Advanced modes

There are two "on" settings for Chord mode: **Basic** (**Bsc**) and **Advanced** (**Adv**).

Basic re-creates the chord mode of the original Polysix. Each time you play a new chord, it will cut off the previous chord. This option ignores the Voice Assign settings.

Advanced uses the Program's Voice Assign parameters to create a variety of different effects, such as mono legato chords with fingered portamento, or poly chords that overlap one another. The Voice Assign settings apply as if the entire chord was a single note, with each pitch in the chord created by an additional transposed oscillator.

Poly, Poly Legato, Single Trigger, Mono, Mono Legato, Legato Offset, Mono Priority, and Mono and Poly Unison all apply.

You can achieve the same effect as **Basic**, above, by setting **Chord** to **Advanced**, **Voice Assign** to **Mono**, **Priority** to **Last Note**, and **Legato** to **Off**.

Creating and editing chords

Chords are assigned to the Pads, stored, and edited as described under “Drum & Chord Pads” on page 48.

Selecting chords

The Chord function uses the chords assigned to the Pads. To select a chord to play from the keyboard (or via MIDI):

1. **Select the desired Pad from the Source pop-up menu**
or:
When Chord is enabled, Press a Chord Pad.

When Chord mode is enabled, pressing a Chord Pad edits the **Source** parameter. The Pad will not play any sounds by itself; it only selects the chord to be played from the keyboard.

Chord mode is enabled when the Chord SW is either unassigned or turned On, and...

- In Program mode, **Chord** is set to **Basic** or **Advanced**
- In Combi mode, **Chord** is set to **Basic** or **Advanced** on any Timbre (with Status set to **INT**) on the Global channel
- In Sequencer mode, **Chord** is set to **Basic** or **Advanced** on any Track (with Status set to **INT** or **BTH**) on the same MIDI channel as the current Keyboard Track

In Combi mode, selection via the Pads affects all Timbres on the Global Channel. In Sequencer mode, this affects Tracks on the same MIDI channel as the current Keyboard Track.

What if Timbres/Tracks share the same channel, but have different Source settings?

If Timbres/Tracks share the same channel but have different Source settings, they will maintain the different settings as long as the Pads are not used to

select a different chord. As soon as a Pad is used, all the Timbres/Tracks will be set to the same chord—unless they are set to **PRG**.

When Source is set to **PRG**, the Timbre/Track uses the Source chord stored in the Program, instead of any of the chords from the current Combi or Song. This makes it easy to use Chord mode for sound-specific effects, such as octaves, stacked fifths, and so on.

Playing chords

The lowest note of the selected chord is transposed to match the note played on the keyboard. Higher notes are transposed accordingly. For instance, let’s say that:

- The stored chord is F4, Bb4, and Eb5
- You play a D3 on the keyboard (or via MIDI)

In this case, the resulting chord will be D3, G3, and C4.

Just as with the Pads, the stored velocities are scaled by the velocity of the played note.

In Combi and Sequencer modes, as long as the root note of the chord is within the Timbre/Track keyboard zone, the entire chord will be played in that Timbre/Track—even if some of the notes extend beyond the Timbre/Track’s key zone.

Chords and MIDI

The **Chord SW** and **Source Pad** settings (including selections via the Pads) are transmitted and received via SysEx, which can be recorded and played back via internal or external sequencers.

In Combi and Sequencer modes, there are discrete SysEx messages per Timbre/Track for both **Chord SW** and **Source Pad**, so that each Timbre/Track can be set individually if desired. Note that this allows more flexibility than when using the local keyboard’s **Chord SW** and Pads.

When the Chord SW or the front-panel Pads are used to change the chord state, separate messages are sent for each affected Timbre or Track, including:

- In Combi mode, each Timbre on the Global Channel
- In Sequencer mode, each Track on the same MIDI channel as the Keyboard Track

Quick Edits using the Sliders, Knobs and Switches

You can edit any of the Programs shipped with OASYS, or you can start with an initialized Program to create sounds from scratch.

You can do many basic edits directly from the front panel Control Surface knobs, switches, and sliders, without ever delving deeper into the LCD interface. For instance, you can use the knobs to change attack and release times, make sounds brighter or darker, alter effects depths, modulate KARMA’s phrase generation, and so on.

The knobs, sliders, and switches will do different things, depending of the Control Surface **CONTROL ASSIGN** setting. For editing Programs, the three

important **CONTROL ASSIGN** settings are **TIMBRE/TRACK**, **R.TIME KNOBS/KARMA**, and **TONE ADJUST**.

TIMBRE/TRACK lets you adjust the volume, pan, and send levels for Oscillators 1 and 2, along with the Program EQ.

R.TIME KNOBS/KARMA lets you modulate sounds and effects with the knobs, and control KARMA with the sliders and switches.

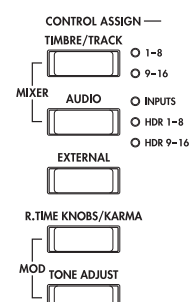

TONE ADJUST gives you hands-on access to more detailed sound editing, using the sliders, knobs, and switches.

Adjusting volume, Pan, EQ, and FX sends

In TIMBRE/TRACK mode, the Control Surface puts all of the basic mixing controls under your fingertips.

1. Press the TIMBRE/TRACK button under CONTROL ASSIGN.

The button's LED will light up.

2. Optionally, go to the Control Surface tab of the Play page.

This page mirrors the Control Surface. Often, it will show you a little more information about the knob assignments, exact values, and so on.

3. Press the MIXER KNOBS button until the INDIVIDUAL PAN LED lights up.



This makes knob 1 control OSC1's pan, and knob 2 control OSC2's pan.

4. Use sliders 1 and 2 to adjust the volumes of OSC1 and OSC2, respectively.

5. Use knobs 1 and 2 to adjust the pan positions of OSC1 and OSC2.

6. Press the MIXER KNOBS button until the CHANNEL STRIP LED lights up.



This makes the knobs control a virtual channel strip, including pan, EQ, and effects sends.

7. Use knobs 2-6 to adjust the Program's 3-band EQ.

The EQ affects both OSC1 and OSC2. Notice that the display shows you the gain values in dB, and the Mid Frequency in Hz. Also note that knob 2, EQ Trim, lets you compensate for gain changes caused by the EQ.

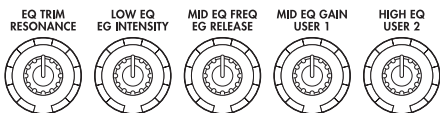

8. Press SELECT button 1.

This selects OSC1. When the knobs are in CHANNEL STRIP mode, the selected Oscillator is important. While EQ always applies to both Oscillators, the Pan and Effects Send 1/2 knobs affect only the selected Oscillator.

Notice that Pan is available, in different ways, with both settings of the MIXER KNOBS button.

9. Use knobs 7 and 8 to adjust Effects Sends 1 and 2 for OSC1.

Internally, the system figures out how the Oscillator is routed to the Master Effects, and automatically adjusts the appropriate send parameters.

Editing sounds & effects with the Real-Time Knobs

The Real-Time Knobs are a traditional feature of KORG workstations, combining modulation, quick edits, and hands-on control.

In R.TIME KNOBS/KARMA mode, knobs 1-4 have dedicated functions which correspond to MIDI CCs. Knobs 5-8 can be assigned to a wide variety of functions, many of which also have corresponding MIDI CCs. Often (but not always), knobs 5 and 6 modulate synthesis parameters, knob 7 controls the depth of a chorus or other modulation effect, and knob 8 controls reverb depth.

When you move a knob, it sends out the corresponding MIDI CC. Also, when the CC is received via MIDI or generated by KARMA, the knob value changes to match the CC value.

Generally, the knobs "scale" the Program's internal settings. When the knob is in the center, the settings are as programmed. To move the settings to their maximum value, turn the knob all the way to the right; to move them to their minimum value, turn the knob all the way to the left.

Knob scaling

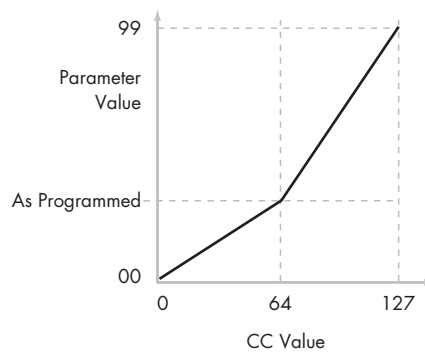

For example:

1. Select Program INT-C 115, "Smooth Operators."

This is an electric piano sound; let's see what we can do to make it sound a bit different.

2. Press the R.TIME KNOBS/KARMA button under CONTROL ASSIGN.

The button's LED will light up.

3. While playing the sound, turn knob 1 (Filter Frequency) to the right, slowly, to about 3 o'clock.

Notice how the piano becomes a sort of synth sweep.

4. Next, turn knob 2 (Filter Resonance) to the right, also to about 3 o'clock.

5. With knob 2 in that position, try moving knob 1 back and forth as you play.

With the resonance increased, it now sounds like you're playing through a wah pedal.

Next, let's say that you decide that's not really what you wanted—so, we'll set the knobs back to their default values. You could move them back to the straight-up, 12 o'clock position, and then adjust them so that they're exactly in the middle, but there's an easier way...

6. Hold the RESET CONTROLS button.

This button is under UTILITY, between the MODE and BANK buttons, to the right of the LCD.



7. While holding RESET CONTROLS, move first knob 1, and then knob 2.

As you move the knobs, their values will be reset to the default, center positions.

8. Release the RESET CONTROLS button.

Now, you're back to the original electric piano sound.

The table below shows the standard assignments of the Real-Time knobs:

Real-Time Knob functions

Knob	MIDI CC	Normally controls...
1	74	Filter Cutoff Frequency
2	71	Filter Resonance
3	79	Filter EG Intensity
4	72	EG Release Time
5-6	Varies for each Program	
7	Often Chorus Depth - but can vary per Program	
8	Often Reverb Depth - but can vary per Program	

Knob edits can be saved

The Real-Time Knobs are great for modulating sounds in performance, or for recording. If you like, you can also save the edited version of the sound, using the normal Write Program command (see "Saving your edits" on page 54).

Internally, a single knob usually affects several different parameters. When you write a Program, the edits are saved into the individual parameters, and not to the knob itself. After writing the Program, you'll notice that the knobs have returned to their center positions—since the old "edited" values are now the new "saved" values.

Using Tone Adjust

Tone Adjust lets you use all of the sliders, knobs, and switches on the Control Surface to edit Program parameters, like the knobs on an analog synth. Each physical control can be assigned to any one of a number of Program parameters.

The specific parameters available through Tone Adjust will vary depending on the type of Program. HD-1 Programs support a certain set of parameters; each EXi also has its own set of parameters. For more information, see:

"Common Tone Adjust Parameters," on page 28 of the Parameter Guide.

"HD-1 Tone Adjust Parameters," on page 29 of the Parameter Guide.

"AL-1 Tone Adjust parameters," on page 210 of the Parameter Guide.

"CX-3 Tone Adjust parameters," on page 232.

Other EXi instruments will have their own set of parameters, as described in their manuals.

Editing sounds

1. Select Program INT-C 115, "Smooth Operators."

2. Press the TONE ADJUST button under CONTROL ASSIGN.

The button's LED will light up.

3. Go to the Control Surface tab of the Play page.

This page mirrors the Control Surface. It's very useful with Tone Adjust, since it shows you the parameter assignments, exact values, and so on.

4. Look at the assignments for sliders 5, 6, and 8.

Slider 5 is assigned to **Amp EG Attack**; slider 6 is assigned to **Amp EG Decay**; and slider 8 is assigned to **Amp EG Release**.

5. Raise each of the three sliders so that they are about 4/5 of the way to the top.

The LCD should show their values as between +60 and +70. In other words, you've just edited the amp envelope so that the attack, decay, and release are all much longer than they were before.

6. Play a few notes.

Notice that the sound has changed from an electric piano into a soft pad. Next, let's add just a bit of pitch modulation, to make the sound more rich.

7. Look at the assignments for knobs 2 and 5.

Knob 2 is assigned to **Pitch LFO 1 Intensity**—in other words, the amount of pitch modulation from LFO1. Knob 5 is assigned to **LFO1 Speed**.

8. Turn knob 2 ever so slightly to the right, so that the LCD reads +01 or +02.

9. Turn knob 5 to the right, until about 2 o'clock, so that the LCD reads about 40.

10. Play a few more notes.

The pitch modulation has added some shimmer to the sound. Now, maybe it could use a bit more edge...

11. Look at the assignments for SELECT switches 1 and 2.

These are programmed to raise the **Filter Frequency** and **Filter Resonance**, respectively. Switches are just on/off, but you can set a specific value for the **On** position; notice the +10 and +40 in the switch's value boxes.

12. Press the two switches, one by one.

The sound now has a more interesting character, due to the filters. Since it's brighter, we've also restored some of the electric piano character.

Pretty easy, huh? Note - depending on the parameter, you may sometimes hear glitches in the sound as you move the control.

Changing parameter assignments

The factory Programs include default assignments of Tone Adjust parameters to the knobs, sliders, and switches. If you like, you can change any of the assignments. To do so:

1. Go to the Control Surface tab of the Play page.

On this page, you can see the parameter assignments for each controller, such as **Filter EG Attack**, **Pitch Stretch**, **Reverse**, and so on.

2. Press the popup button next to one of the parameter assignments.

A popup window will appear, with a long list of parameters. You can tell various things about the selections, just from the way they appear in the list:

- Parameters which affect only OSC1 or OSC2 are prefixed with [OSC1] and [OSC2], respectively.
- Parameters which affect both Oscillators, but which are specific to HD-1 Programs, are prefixed with [OSC1&2].
- The other group of parameters, at the beginning of the list, are “Common.” That is, you can use them with most EXi Programs, as well as HD-1 Programs.
- Parameters can only be assigned to one Tone Adjust control at a time. If a parameter is already assigned, it’s grayed out.

3. Select a parameter from the list.

The parameter is now assigned to the control. To cancel out of the list without making a change, just touch on the screen outside of the popup window.

Using COMPARE

When you’re in the process of editing a sound, pressing the COMPARE button will recall the saved version of the sound, as it was before you started editing. To indicate that you are listening to the saved version, the button’s LED will light up.

Pressing COMPARE again returns you to the version you are editing, and the LED will go out again.

If you edit while the COMPARE LED is lit, the key will again go dark and your previous edits will be lost.

Resetting individual controls

The RESET CONTROLS button lets you revert an individual knob, slider, or switch to its saved setting. For more information, see “Resetting controls to their saved values” on page 47.

Saving your edits

Once you’ve tweaked the sound to perfection, you’ll want to save your work. To save your edits:

1. **Select the Write Program command from the page menu, at the upper right-hand corner of the screen.**

You can also call up this menu command by holding ENTER and pressing 0 on the numeric keypad.

This brings up a dialog box which allows you to save the Program. Optionally, you can also select a new location, change the Program’s name, and assign it to a sound category (such as keyboard, guitar, etc.).

2. **Press the “T” button to bring up the text edit dialog.**

You can give the Program a descriptive name using the on-screen keyboard.

3. **After entering the name, press OK.**

The text edit window will disappear, returning you to the main Write dialog.

4. **Under “To” at the bottom of the dialog, press the popup button next to Program to bring up the save location dialog.**

5. **Select a location to save the edited Program.**

You can write to any location in banks INT–A–E and USER A–G. To avoid overwriting the factory sounds, it’s safer to use a slot in one of the empty User banks.

 **Important:** HD-1 Programs can only be written to HD-1 Banks, and EXi Programs can only be written to EXi Banks. For more information on the default Bank types, and on how to change them, please see “Program Bank Contents” on page 43, and “Changing the Bank Type for USER-A...G” on page 43.

6. **After selecting the location, press OK.**

7. **Press OK again to start the write process.**

8. **If you’re sure you want to write to this location, press OK again.**

After that, you’re done!

For more information, see “Writing a program or combination” on page 164.

Saving edits to GM Programs

You can edit GM Programs, but you must then save them to a Bank other than INT-G; the GM Programs themselves cannot be over-written.

Shortcut: SEQUENCER REC/WRITE

You can also use the SEQUENCER REC/WRITE button to quickly update the current Program, using the existing name, bank, number, and category. To do so:

1. **Press the SEQUENCER REC/WRITE button.**

The Update Program dialog will appear.

2. **Press OK to write the program.**

Saving to disk

You can also save and manage Programs on the internal hard drive, and on USB storage devices. For more information, see “Saving to disks, CDs, and USB media” on page 168.

Detailed Editing with HD-1 Programs

Creating your own Programs

You can create your own original sounds by editing the factory Programs, or by initializing a Program and starting from scratch. You can save these Programs into any bank other than INT-G, which cannot be modified.

You can also create Programs using RAM multisamples that you have sampled or loaded from disk. In addition, you can play a Program and resample your performance, or sample an external audio source while listening to the sound of a Program.

Overview of editing pages

P0: Play is where you select and play programs, make quick edits using the Control Surface, and adjust the KARMA settings. The other pages let you modify the sound in more detailed ways.

Page	Main features
P0: Play	<ul style="list-style-type: none"> • Select and play Programs • Perform easy edits using the Realtime Knobs, KARMA sliders, and Tone Adjust • Adjust mix parameters including volume, pan, EQ, and send levels • Quick sampling and re-sampling
P1: Basic/ Vector	<ul style="list-style-type: none"> • Set the Program to Single, Double, or Drum • Select Multisamples and Wave Sequences • Select Mono or Poly voice allocation • Select a scale (e.g., Equal Temperament) • Set up controllers and drum/chord pads • Set up Vector synthesis
P2: Pitch	<ul style="list-style-type: none"> • Settings related to the pitch, including the pitch EG.
P3: Filter	<ul style="list-style-type: none"> • Settings related to the filter (tone), including the filter EG.
P4: Amp	<ul style="list-style-type: none"> • Settings related to the amplifier (volume), including amp EG and pan.
P5: Common LFO	<ul style="list-style-type: none"> • For each of the two LFO's provided for each oscillator, select the LFO type and speed, etc. (Settings in the pitch, filter, and amp pages determine how much the LFOs affect the sound.)
P6:	—
P7: KARMA	<ul style="list-style-type: none"> • Settings related to KARMA.
P8: Insert Effects	<ul style="list-style-type: none"> • Select insert effects and make settings for them. Specify send levels to the Master effects and routing to the outputs.
P9: Master/ Total Effects	<ul style="list-style-type: none"> • Select Master send effects and Total effects, and adjust their settings.

For details on how to access each mode and page, refer to “Basic operations” on page 34.

The page and parameter structures of EXi Bank programs are different than those of HD-1 Bank programs.

Basic HD-1 Structure

Multisamples and Wave Sequences

The sound of the HD-1 starts with one or more Multisamples. These can be recordings of instruments like piano, bass, guitar, strings, organs, analog synths, and so on, or purely digitally-created timbres.

You can use these Multisamples directly, or use them through Wave Sequences, which play a series of different Multisamples over time to create rhythms or complex, evolving timbres.

Oscillator Mode

HD-1 Single Programs have one oscillator, and Double Programs have two oscillators. Each oscillator includes a complete synthesis voice, with velocity-switched Multisamples, dual filters, EGs, LFOs, and so on.

Drums mode is a special variation of Single mode, and uses a Drum Kit (as created in Global mode) instead of Multisamples.

Single Programs use one oscillator, for a maximum of 172-note polyphony.

Double Programs use two oscillators, for a maximum of 84-note polyphony.

Drum Programs use one oscillator to play a Drum Kit. These will normally have a maximum of 172-note polyphony.

A note about polyphony

Polyphony means the number of notes that you can play at a time. This number will vary depending on the particular sound being played, and how that sound is produced. Generally speaking:

- Double Programs use twice as many voices as Single Programs.
- Wave Sequences use twice as many voices as Multisamples.
- Stereo Multisamples use twice as many voices as Mono Multisamples, and Stereo Wave Sequences use twice as many voices as Mono Wave Sequences.
- If the Vector EG is enabled, the number of voices used increases slightly.

Voice Assign Mode

The Voice Assign Mode selects whether the Program will play polyphonically (**Poly**) or monophonically (**Mono**).

When this is set to **Poly**, you can play both chords and melody lines. When this is set to **Mono**, only one note will sound even if you play a chord.

Normally you'll set this to **Poly**, but **Mono** is useful when playing sounds such as synth basses, synth leads, and other solo instruments. Try switching between Poly and Mono, and listen to the results.

Using Drum Kits

You can create and edit Drum Kits in Global mode. For each note on the keyboard, you can select up to four velocity-crossfaded drum samples, make filter and amp settings, and specify routing to the effects and to the individual audio outputs.

For more information, see “Using Drum Kits” on page 159.

In Programs, once you've set the **Oscillator Mode** to **Drums**, you can select between the 144 user-programmable Drum Kits, plus an additional 9 GM2 kits. For more information on the factory sounds, see the Voice Name List.

Copying settings between OSC1 & OSC2

Many of the Program parameters can be set differently for OSC1 and OSC2. These include all of the parameters on:

- All of the tabs on the OSC/Pitch page, except for the Pitch EG
- All of the tabs on the Filter page

- All of the tabs on the Amp page, except for EQ
- All of the tabs on the LFO page, except for Common LFO
- The AMS Mixer tabs

You can use the page menu's Copy Oscillator command to copy these parameters from one Oscillator to another. You can even copy parameters from an Oscillator in a different Program.

This command is useful when you want to set both Oscillators to the same settings, or when you want to duplicate settings you've used before.

Working with Multisamples

The sound of the HD-1 starts with one or more Multisamples. These can be recordings of instruments like piano, bass, guitar, strings, organs, analog synths, and so on, or purely digitally-created timbres.

You can use these Multisamples directly, or use them through Wave Sequences, which play a series of different Multisamples over time to create rhythms or complex, evolving timbres.

In Single and Double modes, each Oscillator can play up to four Multisamples or Wave Sequences. In Drum mode, there is one Oscillator, and it plays a single Drum Kit.

Multisamples, Wave Sequences, and Drum Kits

Multisamples, Drum Kits, and Wave Sequences allow you to play samples in different ways.

- Multisamples lay out one or more samples across the keyboard. For instance, a very simple guitar Multisample might have six samples—one for each string.
- Wave Sequences play back a series of different Multisamples over time. These Multisamples may crossfade to create smooth, evolving timbres, or change abruptly to create rhythms.
- As the name suggests, Drum Kits are optimized for playing drum samples.

Velocity splits, crossfades, and layers

As mentioned above, unless you're in Drum mode, each Oscillator has four velocity zones, named MS1 (High) through MS4 (Low). This means that the Program can play different Multisamples or Wave Sequences, depending on how hard you play.

Each of these zones has separate settings for Level, Start Offset, and so on. Also, each of the zones can fade into the next, to create smooth velocity transitions. Zones can even be layered together, two at a time.

Selecting Multisamples

Let's create a simple velocity crossfade between two Multisamples, using just OSC1.

1. Go to the OSC1 Basic tab of the OSC/Pitch page.
2. Set the MS1 and MS2 Type parameters to Multisample.



3. Set the Types for MS3 and MS4 to Off.
4. Select ROM Stereo as the Multisample Bank for MS1 and MS2.

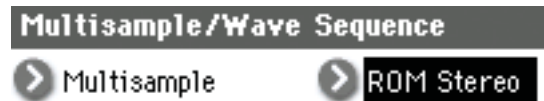

There are three main types of Multisample Banks: ROM, RAM, and EXs. For each type, you can also choose between looking at mono and stereo Multisamples. Note that stereo Multisamples will require twice as many voices as mono Multisamples.

ROM Multisamples are the built-in "factory" sounds, and are always available. These are organized by category, such as pianos, guitars, bells, etc.

RAM Multisamples include Akai, AIFF or WAV files loaded from disk, and samples created in Sampling mode.

EXs Multisample banks are PCM expansion sets created especially for the OASYS. Each has its own unique number; for instance, the ROM Expansion option is EXs1, and the Concert Grand Piano option is EXs2. Only the currently loaded EXs banks will appear in this menu.

5. Press the Multisample popup for MS1.



This brings up a list of Multisamples, organized by category. Use the tabs at the left of the screen to browse through the different categories.

6. Select a Multisample by touching its name in the list.
7. Press the OK button to confirm your selection.
8. Do the same for MS2.

Now that you've assigned Multisamples to MS1 and MS2, let's set up the velocity ranges and crossfades.

9. Set MS2's Bottom Velocity to 001, and its Xfade Range to 0.
10. Set MS1's Bottom Velocity to 80.

Now, MS2 will sound when you play softly, at velocities of 79 or less—and MS1 will sound when you play harder, with velocities of 80 or more.

You can also see this split visually, in the graphic on the right side of the LCD.

11. Next, set MS1's Xfade Range to 20, and its Curve to Linear.

Notice that the graphic now shows the two ranges tapering into one another. Between 80 and 100, MS2 will fade out, and MS1 will fade in, creating a gradual velocity transition instead of a hard split.

12. If you like, adjust the Levels for the two Multisamples.

Using LFOs and Envelopes (EGs)

Using LFOs

Each Oscillator has two LFOs: LFO1 and LFO2. There is also a single Common LFO, shared by both Oscillators. While LFO1 and LFO2 are separate for each voice, the Common LFO is shared by all voices in the Program. This makes it useful when you want all of the voices to have an identical LFO effect.

You can use these LFOs to modulate many different Program parameters, including:

- Pitch (for vibrato)
- Filters (for wah effects)
- Volume (for tremolo)
- Pan (for auto-panning)

The LFOs can modulate many other parameters, in addition to those listed above.

Basic LFO programming

The OASYS LFOs are very powerful, and offer lots of control for the power user. It's simple to get started with them, though—and the graphics on the LCD show how the parameters affect the sound. Let's take a brief tour.

1. Go to the OSC1 LFO1 tab of the LFO page.

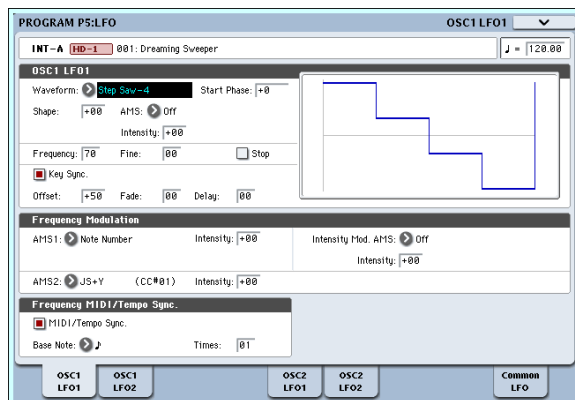

2. Select the Waveform parameter.

3. Use the Inc Δ and Dec ∇ buttons to scroll through the different waveforms, and look at their shapes in the graphic display.

There are a number of waveforms to choose from. Each are suited to different applications:

- **Triangle** and **Sine** are the classic LFO shapes for vibrato, tremolo, panning, and filter wah effects.
- **Square** is useful for gated filter and amp effects, and creates a police siren effect when modulating pitch.

Reverse check box

Reverse lets you play the selected multisample backwards, without looping. This can produce interesting results for sound effects or other unusual timbres. **Reverse** applies only to Multisamples; when the **Type** is set Wave Sequence, this is grayed out.

- The **Guitar** waveform is designed especially for guitar vibrato, since it bends only upwards from the base value.

- **Saw** and **Exponential Saw Down** are good for rhythmic filter and amp effects.

- **Random 1 (S/H)** creates the classic sample-and-hold effect, which is great for modulating a resonant filter.

4. After looking at the different waveforms, select Triangle.

5. Select the Shape parameter, and use the VALUE slider to move through its different settings, from -99 to +99.

Notice how the shape of the waveform becomes more curved, and how -99 emphasizes the lower part of the shape, and +99 emphasizes the upper part.

6. Select the Start Phase parameter, and use the VALUE slider to sweep through its range of values.

Notice how the waveform shifts from side to side. Among other things, this lets you offset the LFOs from one another in time, which can create interesting organic effects.

7. Use the Frequency parameter to set the speed of the LFO.

8. Use the Fade and Delay settings to control the way the LFO sounds at the beginning of the note.

For more information on LFOs, see "Program P5: LFO" on page 83 of the Parameter Guide.

All of these parameters control the way that the LFO itself works. In order for the LFO to actually affect the sound, you can use the dedicated LFO routings on the Filter, Pitch, and Amp pages, or use the LFOs as AMS sources for a wide variety of parameters.

Frequency Modulation

AMS can be used to vary the LFO speed. This lets you change the LFO speed by operating a controller, or by the EG or Keyboard Track settings.

MIDI/Tempo Sync.

If **MIDI/Tempo Sync** is checked, the **Frequency** setting will be ignored, and the LFO will synchronize to the system tempo, as set by the TEMPO knob or external MIDI clocks.

This lets you produce vibrato, wah, auto-pan, or tremolo effects that lock to KARMA, Wave Sequences, the internal sequencer, or external MIDI sequencers.

EGs (Envelope Generators)

An envelope creates a modulation signal by moving from one level to another over a specified time, and then moving to another level over another period of time, and so on.

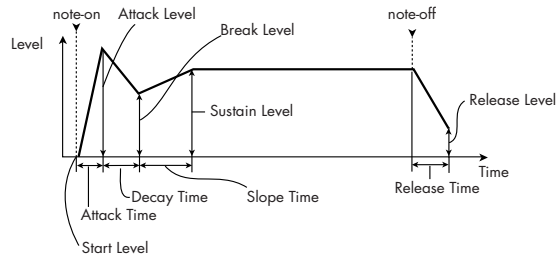

The HD-1 includes three EGs, for Pitch, Filter, and Amp. These produce time-varying changes in pitch, tone, and volume respectively. They can also be used to modulate a number of other Program parameters via AMS.

Using Alternate Modulation (AMS) and the AMS Mixers

AMS (Alternate Modulation Source) refers to any of the assignable modulation sources in OASYS, including:

- Built-in physical controllers, such as the Joystick, Ribbon, and Real-Time Knobs
- Incoming MIDI controllers, or MIDI controllers generated by KARMA or the Vector EG
- Modulators such as the Filter, Pitch, and Amp EGs, the LFOs, or the AMS Mixers

Intensity is a parameter that sets the degree (speed, depth, amount etc.) to which AMS will control the modulation.

A number of frequently-used modulation routings, such as using the joystick to vary the pitch, are provided as additional, dedicated routings, separate from AMS.

Note that not all AMS sources may be available for some modulation destinations.

For details on alternate modulation and AMS, see "Alternate Modulation Sources (AMS)," on page 965 of the Parameter Guide.

Using the AMS Mixers

The AMS Mixers combine two AMS sources into one, or process an AMS source to make it into something new.

For instance, they can add two AMS sources together, or use one AMS source to scale the amount of another. You can also use them to change the shapes of LFOs and EGs in various ways, modify the response of realtime controllers, and more.

The AMS Mixer outputs appear in the list of AMS sources, just like the LFOs and EGs.

This also means that the original, unmodified inputs to the AMS Mixers are still available as well. For instance, if you use LFO 1 as an input to a AMS Mixer, you can use the processed version of the LFO to control one AMS destination, and the original version to control another.

Finally, you can cascade the two AMS Mixers together, by using AMS Mixer 1 as an input to AMS Mixer 2.

Adding two AMS sources together

AMS mixers will do different things depending on their **Type** setting. The **A+B** setting merges two AMS sources into one. This can be handy when you need to add one more modulation source to a parameter, but you've already used up all of the available AMS slots.

For instance, let's say that you're using an LFO to modulate Filter Resonance, and then you decide that it would be interesting to scale that parameter with an EG as well. Resonance has only a single AMS input, but you can easily merge the LFO and the EG together using the A+B AMS Mixer:

1. Assign the LFO to AMS A.
2. Assign the EG to AMS B.
3. Assign the AMS Mixer as the Filter Resonance AMS source.

AMS Mixer A+B example

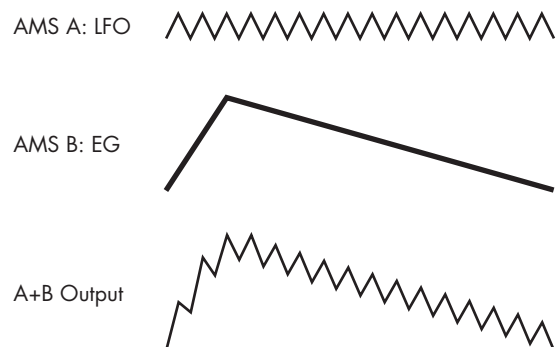

Scaling one AMS source with another

When the **Type** is set to **Amt A x B**, the mixer uses the AMS B input to scale the amount of AMS A. For instance, you can control the amount LFO1 with the Filter EG, or control the amount of the Pitch EG with the ribbon.

AMS Mixer Amt AxB example

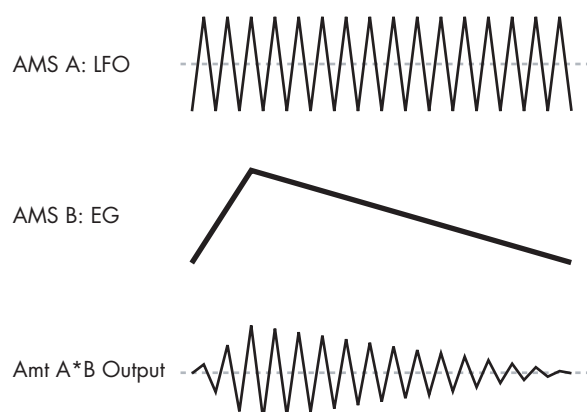

Smoothing

The **Smoothing Type** smooths out the AMS input, creating more gentle transitions between values. You have separate control of the amount of smoothing during the attack (when the signal is increasing) and decay (when it's decreasing).

Low settings provide subtle controller smoothing, creating more gradual aftertouch, for instance. Higher settings create auto-fade effects, transforming a quick gesture into a longer fade-in and/or fade-out event.

Smoothing can also be used to alter the shape of programmable mod sources, such as LFOs and EGs. For instance, you can turn a "blip" into a simple envelope shape, as shown below.

AMS Mixer Smoothing examples

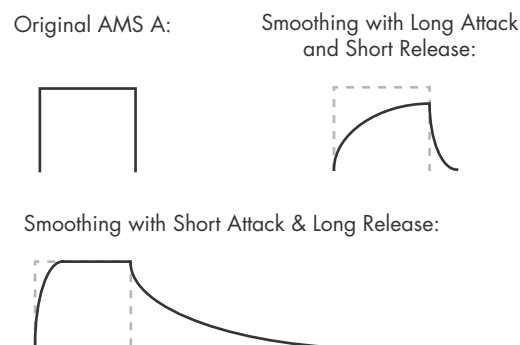

More AMS Mixer features

There are more mixer **Types**, including **Offset**, **Shape**, and **Quantize**, which offer even more possibilities for creative programming. For more details, see "6-1: OSC 1 AMS Mixer" on page 89 of the Parameter Guide.

Suggestions on using AMS

When making settings for alternate modulation, think of the effect that you wish to produce, what type of modulation will be necessary to produce that effect, and what parameter of the oscillator, filter, or amplifier needs to be controlled.

Next, select a source (**AMS**) and set the **Intensity**. If you proceed logically in this way, you will achieve the desired effect.

For example, if you want to control a guitar sound so that it approaches feedback when you move the joystick, you might set up the joystick to modulate the filter frequency and resonance.

Controller Setup page

For each program, this tab lets you make settings for the SW1 and SW2 key, and for Real-Time Knobs 5-8. For more information, see "Setting the functions of SW1 and SW2" on page 180, and "1-8: Set Up Controllers," on page 45 of the Parameter Guide.

Controlling Pitch

Pitch bend

The **JS (+X)** and **JS(-X)** settings specify the amount of pitch change (in semitones) that will occur when MIDI pitch bend messages are received or when the joystick is moved to left or right. A setting of **+12** allows the pitch to be controlled a maximum of one octave upward; a setting of **-12** allows the pitch to be controlled a maximum of one octave downward.

Ribbon specifies the amount of pitch change (in semitones) that will occur when MIDI control change (CC) #16 messages are received, or when you move your finger left and right on the ribbon controller. With a setting of **+12**, the pitch will be raised one octave at the far right of the ribbon controller, and will be lowered by one octave at the far left of the ribbon controller.

Creating Vibrato

You can use an LFO to create vibrato.

LFO 1/2 Intensity sets the depth to which the selected LFO will affect the pitch. With a setting of **+12.00**, vibrato will produce a maximum of ± 1 octave of pitch change.

JS+Y Int specifies the amount of vibrato that the LFO will produce when the joystick is pushed away from yourself.

Intensity (AMS Intensity) specifies the depth of vibrato that will be applied by the LFO when modulated by the selected AMS (Alternate Modulation Source). For example, if **LFO1 AMS** is set to After Touch and you set an appropriate value for **Intensity**, vibrato will be applied when you apply pressure to the keyboard or when MIDI aftertouch messages are received.

Pitch EG

When the **Intensity** value is set to **+12.00**, the pitch EG specified in the Pitch EG page will produce a maximum of ± 1 octave of pitch change.

To realistically simulate the slight change in pitch that occurs when a string is plucked or at the attack of a brass or vocal sound, you can use the EG to create a subtle change in pitch at the attack.

Portamento

Portamento makes the pitch change smoothly when you play the next note before releasing the previous note.

The **Time** parameter controls how long it takes the pitch to change. As this value is increased, the pitch will change over a longer time. With a value of **000**, there will be no portamento.

You can turn Portamento on and off via SW1 or SW2, by assigning them to **Porta.SW CC#65**.

Using Filters

The filters allow you to diminish or emphasize specified frequency areas of the sound.

The tone of the sound will depend significantly on the filter settings.

The basic filter settings, including the routing, type, cutoff frequency, and resonance, are set on the P3: Filter page.

Filter Routing

Each oscillator has two filters, Filter A and Filter B. The **Routing** parameter controls whether one or both of the filters are used, and if both are used, it controls how they are connected to each other.

The **Single** routing uses only Filter A as a single 2-pole, 12dB/octave filter (6dB for Band Pass and Band Reject).

The **Serial** routing uses both Filter A and Filter B. The oscillator first goes through Filter A, and then the output of Filter A is processed through Filter B.

Parallel also uses both Filter A and Filter B. The oscillator feeds both filters directly, and the outputs of the two filters are then summed together.

The **24dB/oct.** routing merges both filters to create a single 4-pole, 24dB/octave filter (12dB for Band Pass and Band Reject). In comparison to Single, this option produces a sharper roll-off beyond the cutoff frequency, as well as a slightly more delicate resonance. Many classic analog synths used this general type of filter.

Serial and Parallel Routing

Serial

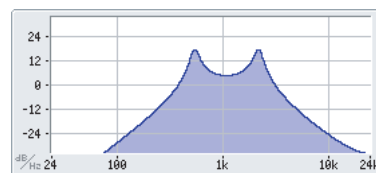

Parallel

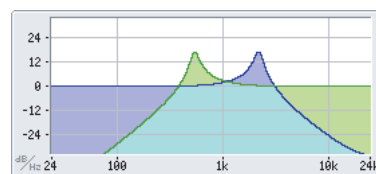
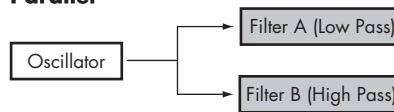

Filter Types

This selects the parts of the sound which will be affected by the filter, as described below. With the Serial and Parallel routings, you can independently set the types for Filter A and Filter B.

The filters will produce very different results depending on the selected filter type. The selections will change slightly according to the selected **Filter Routing**, to show the correct cutoff slope in dB per octave.

Low Pass. This cuts out the parts of the sound which are **higher** than the cutoff frequency. Low Pass is the most common type of filter, and is used to make bright timbres sound darker.

High Pass. This cuts out the parts of the sound which are **lower** than the cutoff frequency. You can use this to make timbres sound thinner or more buzzy.

Band Pass. This cuts out all parts of the sound, both highs and lows, except for the region around the cutoff frequency. Since this filter cuts out both high and low

frequencies, its effect can change dramatically depending on the cutoff setting and the oscillator's multisample.

With low resonance settings, you can use the Band Pass filter to create telephone or vintage phonograph sounds. With higher resonance settings, it can create buzzy or nasal timbres.

Band Reject. This filter type—also called a notch filter—cuts only the parts of the sound directly around the cutoff frequency. Try modulating the cutoff with an LFO to create phaser-like effects.

Filter Types and Cutoff Frequency

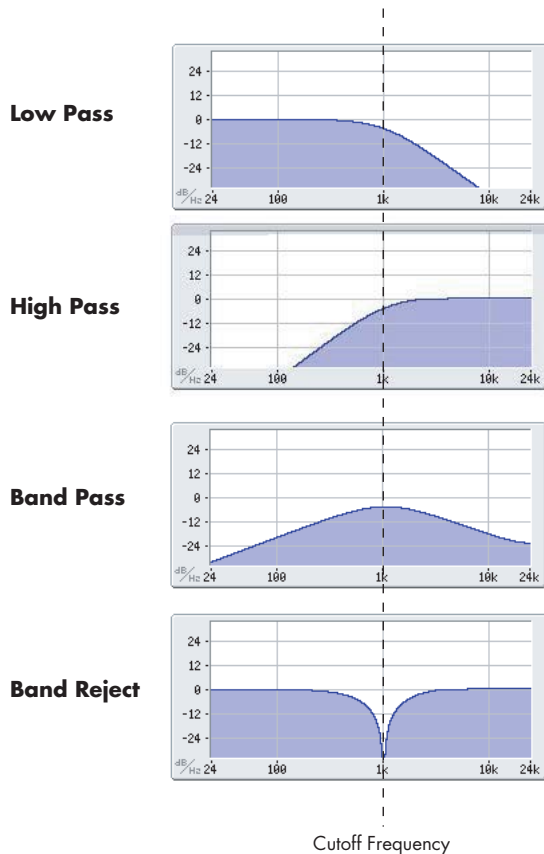

Resonance

Resonance emphasizes the frequencies around the cutoff frequency, as shown in the diagram below.

Low resonance



High resonance

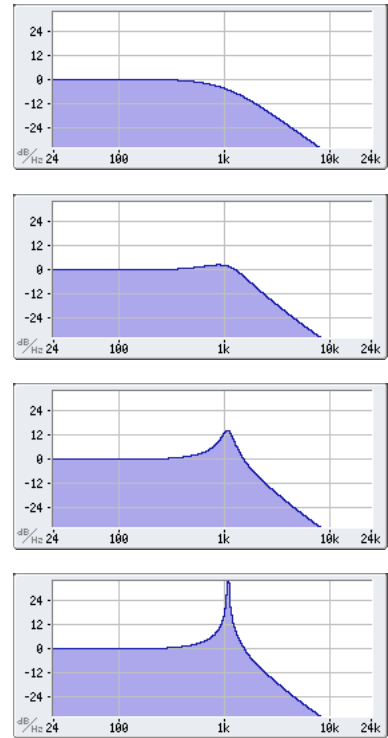

When this is set to 0, there is no emphasis, and frequencies beyond the cutoff will simply diminish smoothly.

At medium settings, the resonance will alter the timbre of the filter, making it sound more nasal, or more extreme. At very high settings, the resonance can be heard as a separate, whistling pitch.

To make the resonance track the keyboard pitch, see “Key Follow,” on page 65 of the Parameter Guide.

Modulating the filters

You can modulate the filter cutoff frequency using the Filter EG, the LFOs, keyboard tracking, and other built-in and MIDI controllers. This is a great way to add a rich variety of tonal change to the sound.

Filter EG

The Filter EG is a multi-stage envelope, which you can use to modulate the filter (naturally!) as well as other Program parameters. The EG itself is set up on the Filter EG tab; the way that it affects the filters is controlled by the parameters described below, on the Filter Mod tab:

The **Intensity to A** and **Intensity to B** settings control the basic amount of EG modulation for filter frequencies A and B, respectively, before other modulation.

The **Velocity to A** and **Velocity to B** settings let you use velocity to scale the amount of EG modulation.

The **AMS** setting selects a AMS modulation source to scale the amount of the Filter EG applied to Filters A and B. The two filters share a single AMS source, with separate intensity settings.

LFO modulation

You can modulate the filter via LFO1, LFO2, and the Common LFO. Among other applications, LFO modulation of the filter can produce the classic “auto-wah” effect.

The Filter LFO Mod tab lets you set up the following parameters separately for each LFO:

Intensity to A and **Intensity to B** specify how much the LFO changes the tone.

JS-Y Intensity to A and **JS-Y Intensity to B** specify the depth of the wah effect produced by the LFO when the joystick is moved toward yourself, or when CC#2 is received.

The **AMS** setting selects a AMS modulation source to scale the amount of the LFO applied to Filters A and B. The two filters share a single AMS source, with separate intensity settings.

For example if, **AMS** is set to **After Touch**, applying pressure to the keyboard produces an “auto-wah” effect.

Keyboard Track

Most acoustic instruments get brighter as you play higher pitches. At its most basic, keyboard tracking recreates this effect by increasing the cutoff frequency of a lowpass filter as you play higher on the keyboard. Usually, some amount of key tracking is necessary in order to make the timbre consistent across the entire range.

The OASYS keyboard tracking can also be much more complex, since it allows you to create different rates of change over up to four different parts of the keyboard. For instance, you can:

- Make the filter cutoff increase very quickly over the middle of the keyboard, and then open more slowly—or not at all—in the higher octaves.
- Make the cutoff increase as you play *lower* on the keyboard.
- Create abrupt changes at certain keys, for split-like effects.

How Key Track works: Keys and Ramps

The keyboard tracking works by creating four ramps, or slopes, between five keys on the keyboard. The bottom and top keys are fixed at the bottom and top of

the MIDI range, respectively. You can set the other three keys—named Low Break, Center, and High Break—to be anywhere in between.

The four Ramp values control the rate of change between each pair of keys. For instance, if the Low-Center Ramp is set to 0, the value will stay the same between the Low Break key and the Center key.

You can think of the resulting shape as being like two folding doors attached to a hinge in the center. At the Center key (the main hinge), the keyboard tracking has no effect. The two folding doors swing out from this center point to create changes in the higher and lower ranges of the keyboard.

Keyboard Track Shape and Intensity

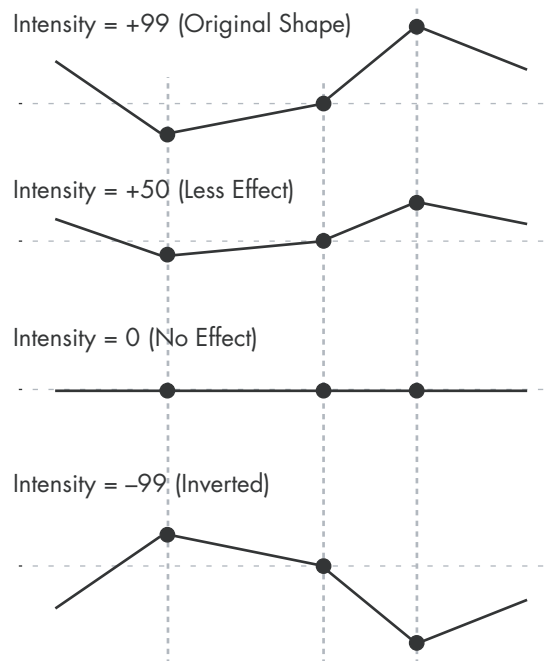

Intensity to A and **Intensity to B** adjust the effect that keyboard tracking will have on filters A and B. For more information, see “3–2a: Keyboard Track,” on page 63 of the Parameter Guide.

AMS Modulation

In addition to the EG, LFOs, and Key Track, you can use two AMS sources to modulate the filters. For instance, you could use the ribbon to change the brightness, or use the AMS output of a Wave Sequence.

Using the Amp section

The Amp section includes controls for volume, pan, and the driver circuit. You can control the volume using the Amp EG, LFO 1/2, Key Track, and velocity, along with other AMS sources.

Each Oscillator has its own Amp section: Amp1 for OSC1, and Amp2 for OSC2.

Background - what does “Amp” mean?

Different sounds have characteristic shapes to their volume levels.

For example, the volume of a piano note begins at a high volume the instant you play the note, and then decreases gradually.

The volume of an organ note, on the other hand, remains constant as long as you continue pressing the key.

The volume of a note on a violin or wind instrument can be varied during the note by the musician (i.e., by regulating the amount of pressure on the bow or the force of the breath).

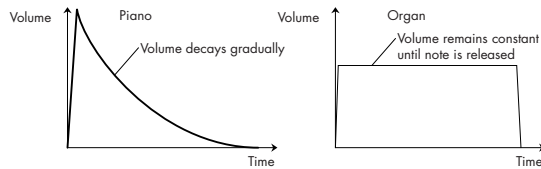

Pan

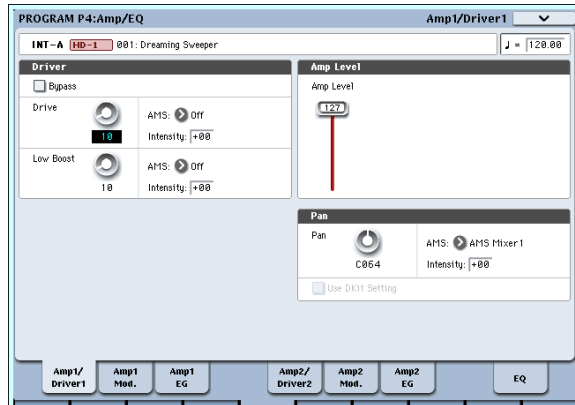

Pan

The main **Pan** parameter controls the stereo position after the signal has passed through the oscillator, filter, and amp. Normally you'll set this to **C064**, so that the sound is centered equally between the left and right speakers.

To create a stereo effect when **Oscillator Mode** is set to **Double**, set the Amp1/Driver 1 page **Pan** to L001, and the Amp2/Driver2 page **Pan** to R127. This will make OSC1 go to the left speaker, and OSC2 go to the right speaker.

With a setting of **Random**, the pan will change randomly each time you play a note on OASYS, producing an interesting effect.

Pan AMS and Intensity

Intensity specifies the depth of the pan modulation from the selected AMS source.

If you set **AMS** to **Note Number**, the pan will change according to the keyboard position of each note played. With a setting of **LFO1** or **2**, the sound will sweep from side to side, creating an auto-pan effect. Other settings allow you to move the oscillator pan by using a real-time controller, an envelope, or other modulation sources.

Pan - Use DKit Setting

Use DKit Setting applies when **Oscillator Mode** is set to **Drums**. If this is **checked**, the Program can use a different pan position for each drum sound, as specified by the Drum Kit. If this is **unchecked**, all drum sounds will use the Program's pan position. The factory presets and GM drum kits use individual pan positions for the different drums, so normally it's best to leave this checked.

Amp modulation

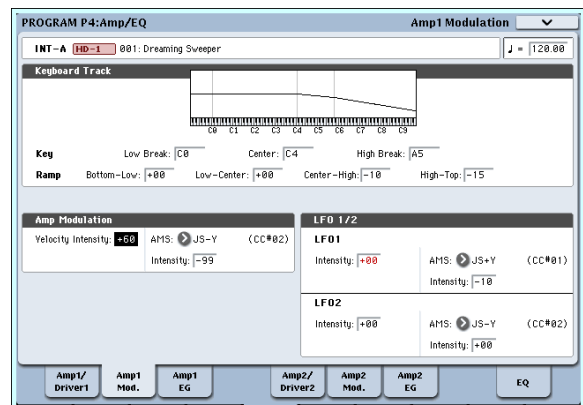

The basic volume level is set by the **Amp Level** parameter. You can then alter this using the modulation sources below:

Keyboard Track

This lets you vary the volume relative to the note you play. For more information, see "Keyboard Track" on page 62.

Amp Modulation

Velocity Intensity is used by most programs to decrease the volume of softly played notes and increase the volume of strongly played notes, and the Amp Modulation parameter adjusts the depth of this control. Normally you will set Amp Modulation to positive (+) values. As this setting is increased, there will be greater volume difference between softly played and strongly played notes.

LFO1/2

Specifies how the LFO's will produce cyclic changes in volume (tremolo effect).

The volume will be affected by the LFO(s) for which you set an **LFO1 Intensity**, **LFO2 Intensity** value.

Intensity (AMS Intensity) adjusts the depth by which the tremolo effect produced by the LFO will be affected when you assign an **AMS** (LFO1 AMS, LFO2 AMS).

For example if you set **AMS** to **JS-Y (CC #02)**, tremolo will be applied when you move the joystick of OASYS toward yourself, or when CC#02 is received.

Amp EG

The Amp EG lets you control how the volume changes over the course of a note.

Every instrument has its own characteristic volume envelope. This is part of what gives each instrument its identifiable character.

Conversely, by changing the volume contour—for instance, applying a string-like Amp EG curve to an organ multisample—you can produce interesting and unusual sounds.

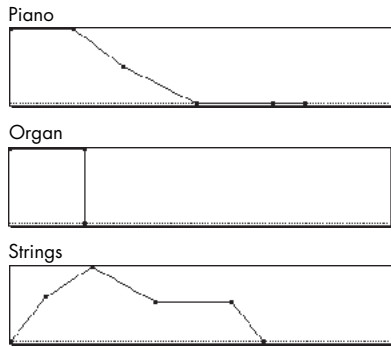

Drive

The Drive circuit adds saturation and overdrive to the sound, for everything from subtle fattening to drastic distortion. Unlike an overdrive effect, Drive processes each voice individually, so the timbre stays the same regardless of how many voices are being played.

The two main parameters, Drive and Low Boost, work together to create the overall effect.

Drive controls the amount of edge and bite in the timbre. Low settings will produce mild saturation, and higher settings create more obvious distortion.

Often, it's useful to increase the **Low Boost** along with the **Drive**.

Note: even when the **Drive** amount is set to 0, the **Drive** circuit still affects the timbre. If your goal is a completely pristine sound, use the **Bypass** control instead.

Low Boost is a special low-frequency EQ which controls the body character of the sound. The specific EQ frequencies affected will change with the Drive setting.

Higher amounts increase the bass boost, and will also intensify the effect of the Drive parameter.

Using Vector Synthesis

Vector Synthesis lets you control Program and Effects parameters by moving the Vector Joystick, by using the programmable Vector Envelope, or by the combination of the two.

What does Vector mean?

Modulation generally works by moving a single control, like a slider, in a straight line. At one end of the control, the modulation is at its minimum; at the other end, it's at its maximum.

Vector Synthesis is a little different. It works by moving around a point on a two-dimensional plane, both left-right and up-down.

You can think of this point as being positioned on two different lines at once: a left-right line (the X axis), and an up-down line (the Y axis).

In other words, instead of just having one value (like a slider), each Vector point has two values: one for X, and one for Y. See the graphic below for an example.

Vector Point and X and Y axis values

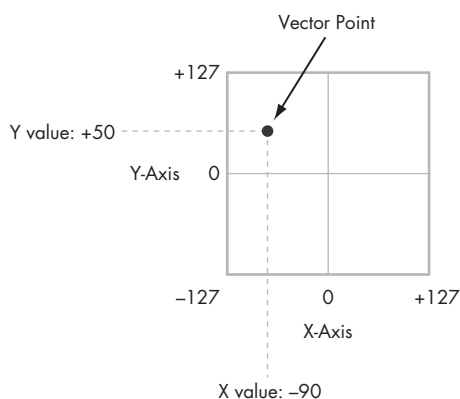

In addition to moving the point directly with the Vector Joystick, you can also use the Vector Envelope to move its position automatically over time, as shown below.

Vector Envelope moving the Vector Point

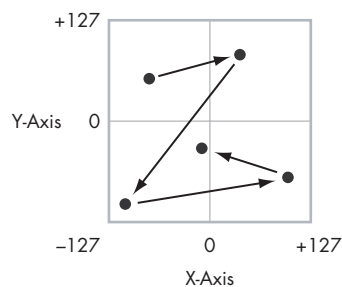

Vector Joystick and Vector Envelope

You can move the Vector point using the combination of the Vector Joystick and the Vector Envelope. The two work together, although you don't necessarily have to use them both at the same time.

When the Vector Joystick is in its center position, the Vector Envelope has complete control over the point's position. Likewise, when the Vector Envelope is in the center, the Vector Joystick has complete control.

When the Vector Envelope is in use, the Vector Joystick offsets the position by up to halfway across either axis. For instance, if the Envelope is all the way to the right of the X axis, and the Joystick is all the way to the left, the actual Vector position will be in the center of the X axis.

Hint: to quickly reset the Vector Joystick to its center value, hold down the front-panel **Control Reset** button and move the joystick.

Vector Volume Control and CC Control

The Vector does two main things: it can control the relative volume of the two Oscillators in Program mode (or of up to 16 Programs at once in Combi mode), and it can generate CCs for controlling Program and Effects parameters.

Vector and MIDI

The Vector features interact with MIDI in two different ways: through the Vector Joystick, and through the Vector CC Control.

The **Vector Joystick** sends and receives two MIDI controllers: one for the X axis, and the other for the Y axis. In Global mode, you can assign these to any MIDI CC numbers you like. The defaults are CC#118 for the X axis, and CC#119 for the Y axis.

The Vector Joystick and its CCs *control* the Vector position, in conjunction with the Vector EG.

The **Vector CC Control**, on the other hand, is *generated* by the Vector position. Normally, this will only affect internal sounds and effects. If you like, however, you can also enable a Global parameter to send these generated CCs to external MIDI devices.

For more information on Vector Synthesis, see “1–5: Vector Control” on page 38 of the Parameter Guide.

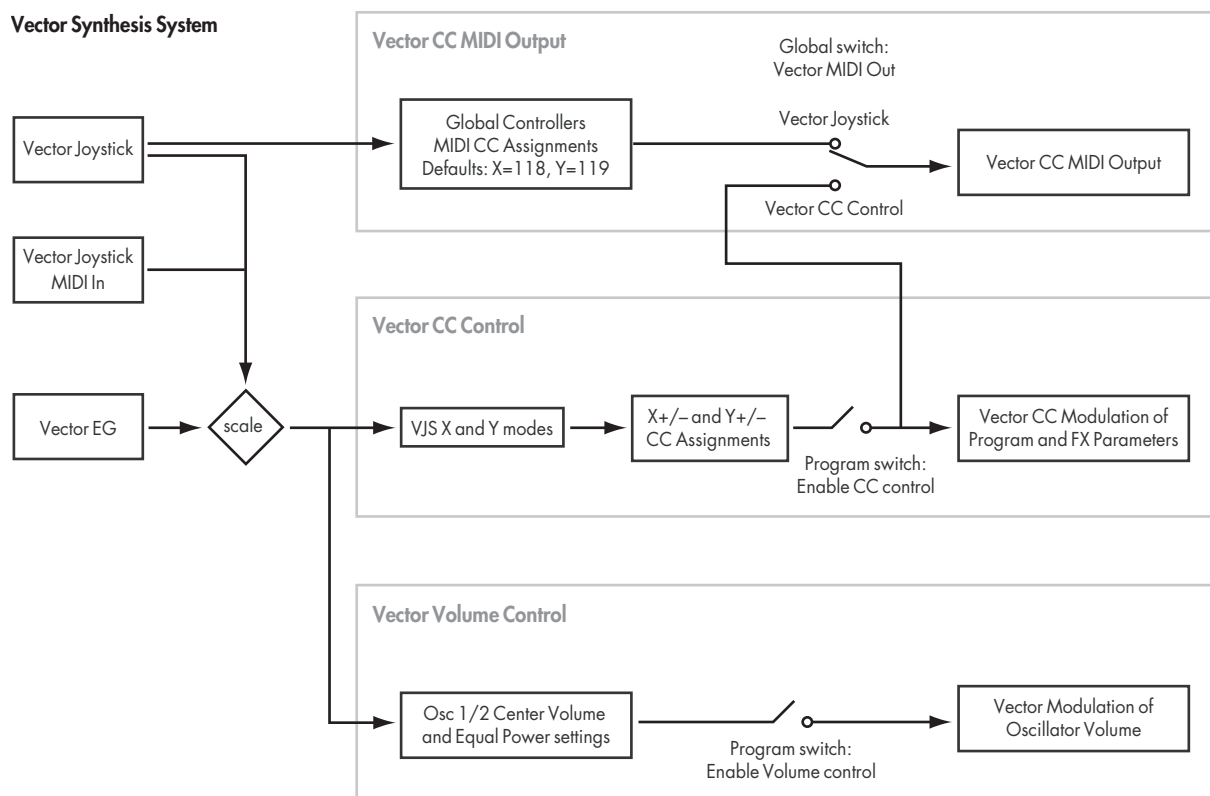

Effects

Effects are covered in their own section of the manuals, so we won't go into too much detail here.

Insert Effects

Insert Effects let you send either individual Oscillators or the entire Program through up to 12 effects, in series. You can use any type of effects, from distortions and compressors to choruses and reverbs. The Insert Effects can be routed to the main outputs, or to any of the individual outputs.

For more information, see “Insert effects” on page 185.

Master Effects

There are two Master Effects, which are accessed through Sends 1 and 2. These are best-suited to effects such as reverbs and delays, but you can use them with any type of effect.

For more information, see “Master effects” on page 186.

Total Effects

The two Total Effects are dedicated to processing the main L/R outputs. They're ideally suited to overall mix effects, such as compression, limiting, and EQ—but as with the other effects sections, you can use any type of effect that you like.

For more information, see “Program P9: Master/Total Effect” on page 134 of the Parameter Guide.

Automatically importing a Program into Sequence mode

The Auto Song Setup feature copies the current Program or Combination into a Song, and then puts the OASYS in record-ready mode.

If inspiration for a phrase or song strikes you while you're playing, you can use this function to start recording immediately. To do so:

1. **Hold down the ENTER key and press the SEQUENCER REC/WRITE key.**

The Setup to Record dialog box will open and ask "Are you sure?"

2. **Press OK.**

You will automatically enter Sequencer mode, and will be in the record-ready state.

3. **Press the START/STOP key to start the sequencer and begin recording.**

Playing and editing Combinations

What's a Combination?

Combinations, or “Combis” for short, let you split and layer up to 16 Programs at once.

A Combi is made up of 16 Timbres. Each Timbre has a Program, along with parameters for key and velocity zones, mixer settings, MIDI channel and controller filtering, and so on.

As with Programs, each Combi has 12 Insert Effects, 2 Master Effects, and 2 Total Effects, for shaping and transforming the sounds of the individual Timbres. Finally, Combis can use 4 KARMA modules at once, for complex and layered generated effects.

Combination overview

Combination Banks and factory sounds

OASYS ships from the factory with 384 factory-programmed Combinations. You can create your own original combinations by editing these factory-set combinations, or by initializing a combination and starting “from scratch.”

Over 1,400 Combination slots are left open for your own programming, or additional sound libraries.

These Combinations are organized into 14 Banks of 128 Combinations each, as described below. You can also store many more Combinations on the hard drive, or on external USB 2.0 devices.

The preloaded Combinations in internal (INT) banks A and B use only the basic PCM ROM, in addition to EXi sounds. The Combinations in internal bank C use the EXs1 ROM Expansion PCM, in addition to the basic ROM. For more details on the factory Combinations, please refer to the Voice Name List.

You can play a Combination and resample your performance, or sample an external audio source while listening to the sound of a Combination.

Combination bank contents

Bank	Contents
INT-A, B	Factory Combinations
INT-C	Factory Combinations; requires the EXs1 ROM Expansion PCM.
INT-D...G; USER-A...G	Initialized Combinations

Combination page structure

The main P0: Play page offers access to the most important aspects of Combis, including:

- Selecting and playing Combinations
- Selecting individual Programs
- Making basic settings for KARMA
- Editing mixer settings and sound parameters via the Control Surface
- Quick sampling and resampling

The detailed editing pages, P1 through P9, give you more in-depth access to the Combi's powerful key and velocity zones, MIDI filtering, Vector Synthesis, KARMA, and Effects.

Page	Main features
P0: Play	<ul style="list-style-type: none">• Select and play Combinations• Perform easy edits using the Realtime Knobs, KARMA sliders, and Tone Adjust• Adjust mix parameters including volume, pan, EQ, and send levels• Select a Program for each timbre• Quick sampling and re-sampling
P1:EQ/Vector/Control	<ul style="list-style-type: none">• Adjust EQ settings for each Timbre• Assign functions to SW1/2 and Real-Time knobs 5-8• Set up Vector synthesis
P2: Timbre Params	<ul style="list-style-type: none">• Set various parameters for each timbre, such as MIDI channel, OSC select, Pitch etc.
P3: MIDI Filter/Zone	<ul style="list-style-type: none">• Set up MIDI transmission/reception filters for each Timbre.• Set up keyboard and velocity zones for each Timbre.
P4:	—
P5:	—
P6:	—
P7: KARMA	<ul style="list-style-type: none">• Make detailed KARMA settings.
P8: Insert Effects	<ul style="list-style-type: none">• Select insert effects and make settings for them. Specify send levels to the Master effects and routing to the outputs.
P9: Master and Total Effects	<ul style="list-style-type: none">• Select Master send effects and Total effects, and adjust their settings.

For details on how to access each mode and page, please see “Basic operations” on page 34.

You can perform sampling and resampling in Combination mode. For more information, see “Sampling in Program, Combination, and Sequencer modes” on page 141.

You can also apply the OASYS's effects to external audio inputs, for a wide range of possibilities. For more information, see “Effect settings for the audio inputs” on page 190.

Combination structure and corresponding pages

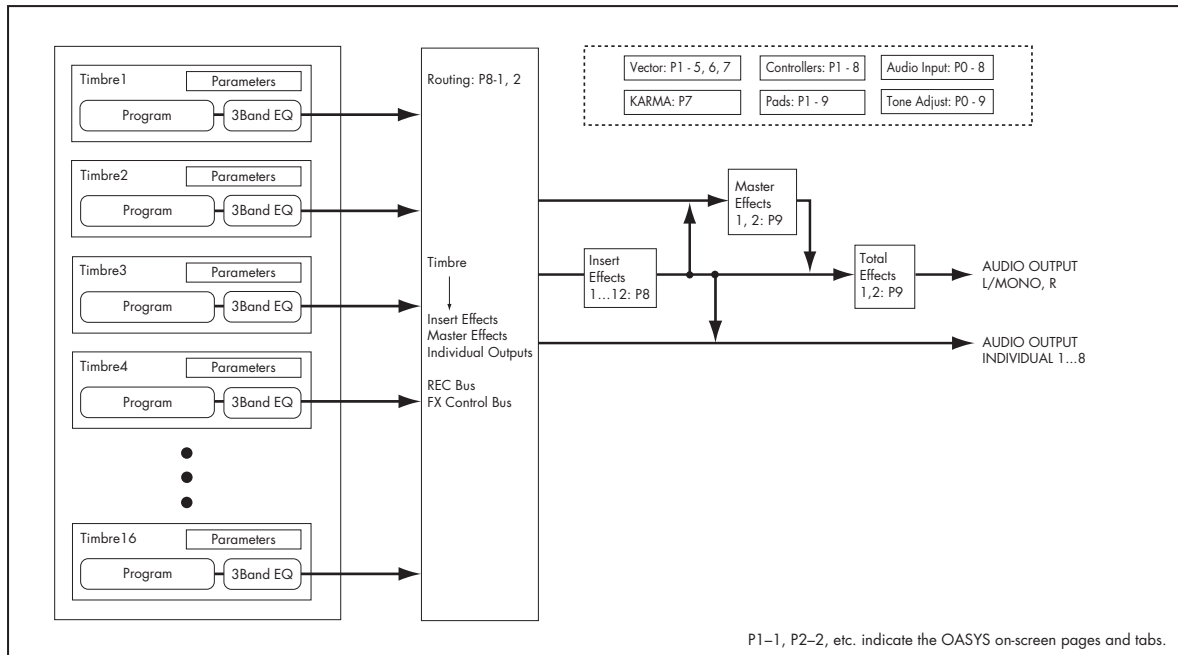

Selecting Combinations

There are several different ways to select Combinations. Each one is convenient in a different way:

- Using the front-panel buttons, value slider, and value knob, you can select Combinations quickly via physical controls
- Selecting by Bank and number (via the touch-screen) lets you browse through all of the Combinations in memory, to find the one that you want
- Selecting by Combination category (via the touch-screen) lets you filter Combinations by sound type, such as Pianos or Drums
- Using a foot-switch lets you change Combinations even while both hands are busy playing on the keyboard - convenient for live applications
- MIDI program change messages let you select Combinations remotely, from either -a MIDI sequencer or an external MIDI controller

Using the front-panel buttons

1. Make sure that the COMBI button, under MODE, is lit.

This means that you're in Combination mode, in which you can select and edit Combinations. If the button isn't lit, press it now; it will light up, and the main Combination Play page will appear.

2. If you're already in Combination mode, go to the main Combination Play page.

The main Play page shows the selected Program, status, pan, and volume for timbres 1-16.

3. Make sure that the Combination name is selected.

If it is not selected, go to the Combination P0: Play page and touch the Combination's name, so that it's highlighted.

4. Use the VALUE controllers to select the Combination number that you wish to play.

You can use the following methods to select a Combination.

- Turn the Value dial.
 - Press the Inc \triangle or Dec ∇ buttons.
 - Use the numeric keypad [0]–[9] to specify the number, and press the ENTER key.
5. Press a BANK button (INT or USER A-G) to switch banks.

When you select a different Bank, the button's LED will light, and the selected bank will appear on the upper left side of the LCD screen.

For example to select bank INT-B, press the B button in the top row of Bank buttons. The B button will light, and the name INT-B will appear in the upper left of the LCD screen.

Selecting by Bank and number

You can select Combinations from a list organized by Combination bank.

1. Press the Combination Select popup button.

The Bank/Combination Select dialog appears.

Bank/Combination Select menu:



In this illustration, bank INT-A is selected. The list on the right shows the Combinations contained in that bank.

2. Press the tabs on the left side of the display to select a bank.
3. Press one of the Combination names in the list to select a Combination.

The selected Combination will be highlighted, and the keyboard will immediately switch to the new sound.

4. If you like, play a few notes to hear the new Combination.

You can play the new Combination while the menu is still showing, without needing to press OK.

5. When you are satisfied with the selected Combination, press the OK button to close the popup menu.

If you press the Cancel button, the selection you made here will be discarded, and you will return to the Combination that had been selected before you opened the menu.

Selecting by Category

You can select Combinations from within a category, such as keyboard, organ, bass, and drums. When shipped from the factory, the preloaded Combinations are organized into 16 categories, each with several sub-categories. There are also 2 more categories, initially named User 16 and User 17, which you can use and rename as desired.

1. Press the Category popup button.

The Category/Combination Select dialog appears.

Category/Combination Select menu

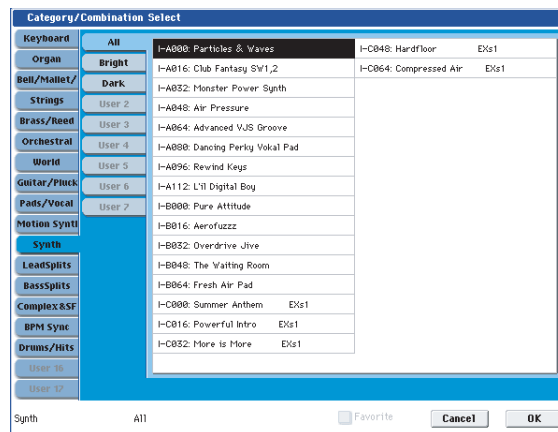

In the illustration above, the Synth is selected. The list on the right shows the Combinations which belong to that category.

2. Press the tabs located to the left side of the display to select a different category.

The name of the selected category will be displayed in full in the lower left.

3. Press one of the Combination names in the center area to select a Combination.

The selected Combination will be highlighted.

4. When you are satisfied with the selected Combination, press the OK button to close the popup menu.

If you press the Cancel button, your selection will be discarded, and you will return to the Combination that had been selected when you opened the popup menu.

Selecting Combinations using a footswitch

You can assign a footswitch to step through Combinations one by one, either going up (0, 1, 2, 3, etc.) or going down (3, 2, 1 etc.). This lets you change Combinations without using your hands—great for quick Program changes in live performance situations.

For more information, see “Using a footswitch to select Programs” on page 45.

Selecting Combinations from MIDI

You can send MIDI Program Change messages to OASYS from external MIDI devices, such as computer sequencers or other MIDI controllers. In conjunction with MIDI Bank Select, you can use these to select any Combination from all 14 Banks.

For more information, see “Selecting combinations,” on page 1003 of the Parameter Guide.

Using controllers to modify the sound

You can use the joystick, ribbon controller, SW1, SW2, Vector Joystick, VALUE slider, keyboard, foot pedals and switches, and the Control Panel knobs, sliders, and switches to control the sound.

For more information, see the corresponding explanation for Programs: “Using Controllers” on page 45.

Easy Combination editing

Changing the Programs within the Combi

Changing the Programs assigned to the 16 Timbres is a quick way to dramatically alter the sound of the Combination.

There are two ways to select Programs for a Timbre:

- Selecting Programs from the front panel and LCD, either by Bank or by Category
- Selecting Programs via MIDI program change messages

Note: MIDI program changes only work for Timbres whose Status is set to INT.

Selecting Programs from the front panel and LCD

To change the Program assigned to a Timbre:

1. Go to the Prog Select/Mixer tab of the Play page.

This page shows all 16 Timbres at once, including their Program assignments, volume, pan, play/mute, solo, and more.

2. Touch the popup button at the top of Timbre 1.

This is the Category select button. It brings up a window which allows you to select a Program by Category, identical to the similar function in Program mode.

3. Select a Program, and press OK.

The Category Select window will disappear. Note that the new Program is now selected for Timbre 1.

4. Press the popup button directly under the Category button.

This is the Bank/Number select button. It brings up a window which lets you select Programs by Bank—again, just like the similar window in Program mode.

5. Select a different Program, and press OK.

The Program in the Timbre is now changed to the one you just selected. Also, the Bank /Number parameter is now highlighted, which means that we can use the front panel buttons to select Banks and Programs.

6. Press one of the front-panel Bank buttons.

Notice that Timbre 1's Bank and Program change to match the selected Bank.

7. Use Inc/Dec, the VALUE dial, or the numeric keypad to select the Program.

Adjusting the mix

You can use both the Control Surface and the LCD to set the volume, pan, and EQ settings for each Timbre, as well as their PLAY/MUTE and Solo On/Off states.

Setting mix parameters from the LCD

1. Go to the Prog Select/Mixer tab of the Play page.

This page shows the volume, pan, play/mute, solo, and Program assignments for all 16 Timbres.

2. Select the on-screen Volume slider for Timbre 1.

3. Use Inc/Dec, the VALUE dial, or the numeric keypad to set the volume as desired.

4. Select the on-screen Pan knob for Timbre 1, and edit its value as desired.

Timbre pan interacts with the pan stored in the Program. A setting of C064 reproduces the Program's oscillator pan settings. Adjusting the Timbre Pan will move the sound to left or right while preserving the pan relationship between the oscillators. A setting of L001 is far left, and R127 is far right.

Using the Control Surface for the mix

You can also edit the mixer parameters directly from the Control Surface, eight Timbres at a time.

1. Press the TIMBRE/TRACK button under CONTROL ASSIGN, so that the 1-8 LED lights up.

The button has two LEDs: one for Timbres 1-8, and the other for Timbres 9-16. Press the button to switch between the two.

2. Optionally, go to the Control Surface tab of the Play page.

3. Press the MIXER KNOBS button until the INDIVIDUAL PAN LED lights up.



This makes knob 1 control Timbre 1's pan, and knob 2 control Timbre 2's pan, and so on.

4. Use sliders 1-8 to adjust the volumes of Timbres 1-8, respectively.

5. Use knobs 1-8 to adjust the pan positions of Timbres 1-8.

6. Press the MIXER KNOBS button until the CHANNEL STRIP LED lights up.

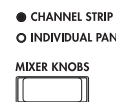

This makes the knobs control a virtual channel strip, including pan, EQ, and effects sends.

7. Press MIX SELECT button 1.

The Channel Strip now controls the Pan, EQ, and FX Sends for Timbre 1.

8. Use knobs 2-6 to adjust the Timbre's 3-band EQ, and knobs 7 and 8 to control the Timbre's Effects Sends 1 and 2.

Internally, the system figures out how the Oscillator is routed to the Master Effects, and automatically adjusts the appropriate effects send parameters.

9. Press MIX SELECT button 2.

The Channel Strip now controls the Pan, EQ, and FX Sends for Timbre 2. Each Timbre has its own, dedicated stereo 3-band EQ.

10. Edit the Channel Strip for Timbre 2 as desired.

Notice that Pan is available, in different ways, with both settings of the MIXER KNOBS button.

Easy KARMA editing

KARMA stands for "Kay Algorithmic Realtime Music Architecture." It's an immensely powerful performance tool, which can provide a wide range of musical effects including:

- Arpeggiation
- Drum and instrument grooves
- Complex CC gestures (as if it was automatically moving knobs or joysticks for you)
- Musical phrase generation, such as piano flourishes
- Any combination of the above
- ...and much more.

You can control many KARMA parameters directly from the front panel.

Turning KARMA on and off

The overall control for KARMA is the ON/OFF button. Turn the button on (LED lit) to enable KARMA; turn the button off (LED off) to disable KARMA.

LATCH button

When LATCH is turned on, KARMA will continue to play even after you've stopped playing on the keyboard, drum/chord pads, or MIDI In.

This is convenient when you want to play on top of a KARMA-generated groove, for instance.

CHORD ASSIGN button

This lets you assign notes and chords to the drum and chord pads. There are a several different ways to do this; here's one of them:

1. Play a single note, or a chord of up to 8 notes.
2. Press the CHORD ASSIGN button.
3. Press the pad to which you'd like to assign the notes.

That's it—the note or chord is now assigned to the pad. For more information, see "Drum & Chord Pads" on page 48.

Selecting KARMA Scenes

Each Combi can have up to 8 KARMA "Scenes," which are presets for the KARMA parameters. Different Scenes may produce dramatically different effects. You can select Scenes directly from the Control Surface:

1. Press the R.TIME KNOBS/KARMA button under CONTROL ASSIGN.

The Control Surface will switch to Real-Time Knobs and KARMA mode.

2. Select Scenes by pressing the top row of Control Panel switches.

Note that not all Combis will necessarily have 8 different Scenes.

Editing KARMA parameters via the sliders

You can also edit various KARMA parameters in real time, using the Control Surface sliders. The specific parameters will vary depending on the Combi, so it may be helpful to look at the LCD:

1. Go to the Control Surface tab of the Play page.
2. Press the R.TIME KNOBS/KARMA button under CONTROL ASSIGN.

The LCD will now show the KARMA parameters assigned to the sliders and switches.

3. Move the sliders to change the KARMA parameters.

For more information on KARMA, see the "KARMA GE guide" on page 893 of the Parameter Guide.

Combination editing

You can edit the preloaded combinations (Banks A, B, and E) with which the OASYS is shipped, or start with an initialized Combination to create your own original sounds.

You can use the factory Programs to create new Combis, or use your own custom Programs. If you're in the process of editing a Program in Program mode, and you use the Program in a Combi, you'll hear the edited version in Combi mode as well.

A suggested approach for editing

First, select a Program for each Timbre, on the Program Select/Mixer tab of the P1: Play page. (Note that you don't *have* to use all 16 Timbres!)

Next, create any desired keyboard or velocity splits, layers, or crossfades between the different Timbres. You can do this on the Keyboard Zones and Velocity Zones tabs of the P3: MIDI Filter/Zones page.

After this, adjust the volumes of the Timbres (back on the Program Select/Mixer tab), and set up any other Timbre parameters as desired.

To add finishing touches to the sound, set up the Insert, Master, and Total Effects as desired (on the P8: Insert Effects and P9: Master/Total Effects pages,

respectively.) These effects can be different from those of the individual Programs in Program mode, if desired.

In addition, you can make KARMA settings (on the P7: KARMA page) and controller settings (on the P3: MIDI Filter/Zones page) to create the finished Combination.

Soloing timbres

You can use the Control Surface Solo function to listen to the Combi's individual Timbres. For more information, see "Solo switch and Select switches 1–8" on page 336.

Using COMPARE

When you're in the process of editing a sound, pressing the COMPARE button will recall the saved version of the sound, as it was before you started editing. To indicate that you are listening to the saved version, the button's LED will light up.

Pressing COMPARE again returns you to the version you are editing, and the LED will go out again.

If you edit while the COMPARE LED is lit, the key will again go dark and your previous edits will be lost.

Resetting individual controls

The RESET CONTROLS button lets you revert an individual knob, slider, or switch to its saved setting. For more information, see “Resetting individual controls” on page 54.

Layers, Splits, and Velocity Switches

Within a Combination, you can use note number and velocity to determine which Timbres will sound.

The Programs assigned to each Timbre can sound in three ways: as part of a **layer**, a **split**, or a **velocity switch**. A Combination can be set to use any one of these methods, or to use two or more of these methods simultaneously.

Layer

Layers cause two or more Programs to sound simultaneously when a note is played.

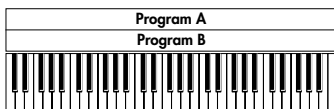

Layer:
Two or more programs sound simultaneously.

Split

Splits cause different Programs to sound on different areas of the keyboard.

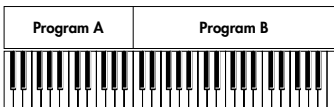

Split:
Different programs will sound in different areas of the keyboard.

Velocity Switch

Velocity Switches cause different Programs to sound depending on the velocity (how hard you play the notes).

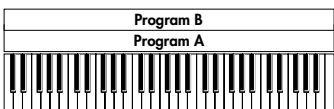

Strong ↑ Keyboard playing dynamics
Soft ↓ Keyboard playing dynamics
Velocity Switch:
Keyboard playing dynamics (velocity) switches between different programs.

On OASYS, you can use a different Program for each of up to sixteen Timbres, and combine two or more of the above methods to create even more complex setups.

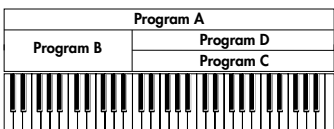

Strong ↑ Keyboard playing dynamics
Soft ↓ Keyboard playing dynamics
Example:
B and C/D are split. In the lower keyboard range, A and B are layered. In the higher keyboard range, C and D are switched by velocity and layered with A.

As an additional possibility, you can set the slope for a key zone or velocity zone so that the volume diminishes gradually. This lets you change a split into a keyboard crossfade, or a velocity switch into a velocity crossfade.

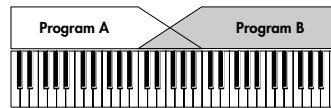

Keyboard X-Fade (keyboard crossfade):
As you play from low notes to high notes, the volume of A will fade out, and the volume of B will fade in.

Creating Key Splits and Layers

Let's create a Combi which combines both splits and layers, like the diagram below:

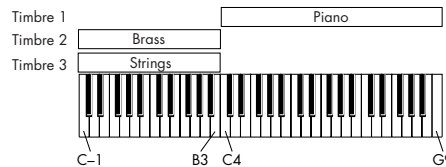

1. Go to the Prog Select /Mixer page.
2. Select a piano sound for Timbre 1, a brass sound for Timbre 2, and a strings sound for Timbre 3.
3. Go to the MIDI tab of the P2: Timbre Parameters page.
4. For Timbres 1-3, set Status to INT and MIDI Channel to Gch (the Global Channel).
5. Go to the Keyboard Zones tab of the MIDI Filter/Zones page.
6. Set Timbre 1's Top Key to G9, and its Bottom Key to C4.
7. Set Timbres 2 and 3 to a Top Key of B3, and a Bottom Key of C-1.

You can also enter these values by selecting the parameter, and then holding down the ENTER key and playing a note on the keyboard.

Key Zone Slope

In addition to “hard” splits, in which the sound changes abruptly, you can use the Slope parameters to gradually fade a sound in or out over a range of keys.

In the example above, you could set the Bottom Key of timbre 1 to G3, and set the Top Key of timbre 2 to G4, so that these two timbres overlap.

Next, if you set the **Bottom Slope** of timbre 1 to 12, and set the **Top Slope** of timbre 2 to 12, the sound will change gradually instead of changing suddenly.

Creating Velocity Switches

Next, let's create a simple velocity switched Combination, like the diagram below:

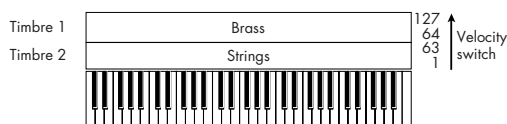

1. Go to the Prog Select /Mixer page.
2. Select a brass sound for Timbre 1, and a strings sound for Timbre 2.
3. Go to the MIDI tab of the P2: Timbre Parameters page.
4. For Timbres 1 and 2, set Status to INT and MIDI Channel to Gch (the Global Channel).
5. Go to the Velocity Zones tab of the MIDI Filter/Zones page.

6. Set Timbre 1's Top Velocity to 127, and its Bottom Velocity to 64.

7. Set Timbre 2 to a Top Velocity of 63, and a Bottom Velocity of 1.

Velocity Zone Slope

Similar to Key Zone Slopes, as described above, these let you fade in and fade out sounds gradually over a velocity range, instead of a simple hard switch.

In the case of the above example, you could set the velocity zones of the two Timbres so that they partially overlap. Then, set the Top Slope and Bottom Slope so that the sound changes gradually, instead of changing suddenly between velocity values of 63 and 64.

MIDI Settings

Timbre Parameters MIDI page

Status

This controls the status of MIDI and the internal tone generator for each Timbre. Normally, if you're playing an internal Program, this should be set to INT.

If the status is set to **Off**, **EXT**, or **EX2**, that internal sounds will not be played. **Off** simply disables the Timbre entirely. The **EXT** and **EX2** settings allow the Timbre to control an external MIDI device. For more information, see "Status" on page 360 of the Parameter Guide.

Bank Select (when status=EX2)

When the **Status** is set to **EX2**, these parameters allow you to transmit MIDI Bank Select messages for changing banks on external MIDI devices.

MIDI Channel

Timbres that you wish to play from OASYS's keyboard must be set to the global MIDI channel. Your playing on the keyboard is transmitted on the global MIDI channel, and will sound any timbre that matches this channel. Normally you will set this to Gch. When this is set to **Gch**, the MIDI channel of the timbre will always match the global MIDI channel, even if you change the global MIDI channel.

- ⚠ On some preloaded combinations, Timbres used by KARMA may have their MIDI Channels set to something other than Gch. These will be timbres

that play only when KARMA is on—a very useful technique for creating "KARMALized" combinations.

For more information, see "7-1c: MIDI I/O" on page 376 of the Parameter Guide. In particular, note the relationships between KARMA assignments and MIDI Channel.

MIDI filter settings

For each MIDI Filter item, you can specify whether or not the corresponding MIDI message will be transmitted and received. The **checked** items will be transmitted and received.

The MIDI filters don't turn the functions themselves on or off. Instead, the filter just controls whether or not that MIDI message will be transmitted and received.

For example, if portamento is on, portamento will be applied to the internal OASYS sound even if Portamento SW CC#65 is unchecked.

As another example, let's say that you've selected a bass Program for Timbre 1, and a piano Program for Timbre 2, with the goal of creating a bass/piano split. You could make the following settings so that pressing the damper pedal affects only Timbre 2's piano sound:

1. Go to the MIDI Filter 1 tab of the MIDI Filter/Zones page.
2. Check the Enable Damper box for Timbre 1.
3. Un-check the Enable Damper box for Timbre 2.

Altering Programs to fit within a Combination

You can make various changes to Programs within the context of a particular Combination, to make them fit better with other Programs, or to create particular sonic effects. These changes do not affect the original Programs, or how those Programs sound in other Combinations.

Timbre Parameters: OSC

Force OSC Mode

Normally this should be set to **PRG**, so that the sound will play as set by the original Program.

If you wish to force a polyphonic program to sound monophonically, set this either to **MN** (Mono) or **LGT** (Legato). Conversely, set this to **Poly** if you wish to force a monophonic program to play polyphonically.

For more information, see “Force OSC Mode,” on page 361 of the Parameter Guide.

OSC Select

Normally, this should be set to **BTH** (Both).

If the timbre is using a program whose **Oscillator Mode** is **Double**, and you want only OSC1 or OSC2 (not both) to sound, set this to **OSC1** (only OSC1 will sound) or **OSC2** (only OSC2 will sound).

Portamento

Normally, this should be set to **PRG**.

If the Program uses portamento, but you’d like to disable this for the current Combination, set this parameter to **Off**.

Conversely, if you want to force the portamento to be on, or just to change the portamento time, set this to a value of **001–127**. The portamento will change to use the newly specified time.

Timbre Parameters: Pitch

Transpose, Detune (BPM Adjust)

These parameters adjust the pitch of the timbre.

- In a layer-type combination, you can set two or more timbres to the same program, and create a richer sound by using **Transpose** to shift their pitch apart by an octave or by using **Detune** to create a slight difference in pitch between the two.
- In split-type combinations, you can use **Transpose** to shift the pitch (in semitone units) of the programs specified for each key zone.
- If you wish to change the playback pitch of a drum program, use **Detune**. If you change the **Transpose** setting, the relationship between notes and drum sounds will change.

Adjusting the BPM of multisamples or samples created in Sampling mode

If a timbre’s program uses multisamples or samples that you created in Sampling mode (or loaded in Disk mode) at a specific BPM value, you can use the page menu command **Detune BPM Adjust** to call up a new BPM value. This changes the BPM by adjusting the playback pitch.

Effects

Effects are covered in their own section of the manuals, so we won’t go into too much detail here.

Insert Effects

Insert Effects let you send either individual Oscillators or the entire Program through up to 12 effects, in series. You can use any type of effects, from distortions and compressors to choruses and reverbs. The Insert Effects can be routed to the main outputs, or to any of the individual outputs.

For more information, see “Detune BPM Adjust,” on page 408 of the Parameter Guide.

Use Program’s Scale, Scale

This specifies the scale for each timbre. If you **check Use Program’s Scale**, the scale specified by the program will be used. Timbres for which this is **not checked** will use the **Scale** setting.

Delay

You can set some Timbres so that they don’t sound immediately at note-on. This can create cool effects, and more dramatic layers.

You can specify the delay for each Timbre either in milliseconds (ms), or in rhythmic values which sync to the system tempo.

If you set the Delay to **Key Off**, the Timbre will sound when the note is released.

Editing Programs with Tone Adjust

Using Tone Adjust, you can make detailed edits to Programs within the context of the Combi. These edits will not affect the original Program, or any other Combis which use the Program. To edit a Program with Tone Adjust:

1. **Press the TONE ADJUST button under CONTROL ASSIGN.**

The button’s LED will light up.

2. **Go to the Control Surface tab of the Play page.**

This page mirrors the Control Surface. It’s very useful with Tone Adjust, since it shows you the parameter assignments, exact values, and so on.

3. **Select the Timbre whose parameters you’d like to adjust.**

This corresponds to the Timbre selected in TIMBRE/TRACK mode. You can set this using the Timbre parameter on the right side of the LCD, or by holding down the TONE ADJUST button and pressing any of the Control Panel switches. The top row selects Timbres 1-8, and the bottom row selects Timbres 9-16.

4. **Edit the controls as desired.**

In addition to editing the values, you can also change the assignments of Tone Adjust parameters to the sliders, knobs, and switches. For more information, see “Using Tone Adjust” on page 53.

For more information, see “Insert effects” on page 185.

Master Effects

There are two Master Effects, which are accessed through Sends 1 and 2. These are best-suited to effects such as reverbs and delays, but you can use them with any type of effect.

For more information, see “Master effects” on page 186.

Total Effects

The two Total Effects are dedicated to processing the main L/R outputs. They're ideally suited to overall mix effects, such as compression, limiting, and EQ—but as with the other effects sections, you can use any type of effect that you like.

Automatically importing a Combination into Sequencer mode

The Auto Song Setup feature automatically applies the settings of the current Combination to a song.

If inspiration for a phrase or song strikes you while you're playing a program or combination, you can use this function to start recording immediately.

Hold down the ENTER key and press the SEQUENCER REC/WRITE key. The "Setup to Record" dialog box will open and ask "Are you sure?". Press "OK". You will automatically enter Sequencer mode, and will be in the record-ready state. Press the START/STOP key to start the sequencer and begin recording.

Saving your edits

Once you've tweaked the sound to perfection, you'll want to save your work. To save your edits:

1. **Select the Write Combination command from the page menu, at the upper right-hand corner of the screen.**

You can also call up this menu command by holding ENTER and pressing 0 on the numeric keypad.

This brings up a dialog box which allows you to save the Combination. Optionally, you can also select a new location, or change the Combination's name.

2. **Press the "T" button to bring up the text edit dialog.**

You can give the Combination a descriptive name using the on-screen keyboard.

3. **After entering the name, press OK.**

The text edit window will disappear, returning you to the main Save dialog.

4. **Under "To" at the bottom of the dialog, press the popup button next to Combination to bring up the save location dialog.**

5. **Select a location to save the edited Combination.**

You can write to any location in banks INT and USER A-G. To avoid overwriting the factory sounds, it's safer to use a slot in one of the empty User banks.

6. **After selecting the location, press OK.**

7. **Press OK again to start the write process.**

8. **If you're sure you want to write to this location, press OK again.**

After that, you're done!

For more information, see "Writing a program or combination" on page 164.

Saving to disk

You can also save and manage Combinations on the internal hard drive, and on USB storage devices. For more information, see "Saving to disks, CDs, and USB media" on page 168.

Creating songs (Sequencer mode)

Overview - About the OASYS' sequencer

The OASYS' sequencer can hold up to 200 songs and 400,000 MIDI events or 300,000 audio events. It consists of a 16-track MIDI sequencer and a 16-track hard disk recorder, giving you a total of 32 tracks.

You can use the sixteen MIDI tracks and one master track (containing tempo data, etc.) to record and play back MIDI data using internal or external tone generators, and use the sixteen audio tracks of the hard disk recorder to record and play back audio signals. (You can play back up to sixteen audio tracks simultaneously, and record up to four audio tracks simultaneously.)

Audio tracks can record external audio sources such as guitar and vocal, as well as the OASYS' internal tone generator. Automation data for volume and pan can also be recorded.

When you've completed a song, you can resample it to a WAVE file and use Disk mode to burn your WAVE files to an audio CD. This entire process can be carried out on the OASYS itself without using any other equipment.

With its broad range of capabilities such as its In-track Sampling function, Time Stretch/Slice function, KARMA function, high-quality effects, and controllers, the OASYS is the ideal environment for music production or live performance.

⚠ When you turn off the power, the settings made in Sequencer mode and the song data, and any user pattern data that you recorded will not be backed up. If you wish to keep this data, you must save it on media (such as the internal hard disk or CD-R, or an external USB device) before turning off the power, or perform a MIDI data dump to save the data on an external data filer etc.

If you wish to save the programs, track parameters, effects, and KARMA function settings etc. selected for a song as a template song, use the page menu command "Save Template Song."

Immediately after the power is turned on, OASYS will not contain any song data, so if you wish to play a song on the sequencer, you must first load data from disk, or receive a MIDI data dump from a MIDI filer. For more information, see "Loading data from disk" on page 171, and "Receiving SysEx data dumps" on page 686 of the Parameter Guide.

⚠ You can't record audio tracks if **MIDI Clock** is other than Internal. (See "MIDI Clock (MIDI Clock Source)" on page 652 of the Parameter Guide.)

Sequencer mode structure

Songs

A song consists of MIDI tracks 1–16, a master track, audio tracks 1–16, song parameters such as the song name, vector function, KARMA function, effect and RPPR parameters, and 100 user patterns.

A maximum of 200 such songs can be created on OASYS.

MIDI tracks 1–16 and audio tracks 1–16 each consist of setup parameters located at the start location, and musical data within the track. The master track consists of tempo and time signature data.

For more information, see "Setup parameters & Musical data" on page 413 of the Parameter Guide.

Song recording and editing

Song recording is performed on tracks. You can record MIDI tracks in either of two ways; realtime recording or step recording. For realtime recording you can choose one of six recording modes.

Audio tracks can be recorded only in realtime. You can also paste WAVE files to locations you specify.

You can edit MIDI tracks by using Event Edit operations to modify the recorded data or insert new data, and by using Track Edit operations such as Create Control Data, which inserts pitch bend, aftertouch, or control change data.

You can also edit audio tracks in a variety of ways including Event Editing operations that let you insert or delete audio events, and Region Editing operations. Region Editing allows you to select WAVE files and to edit the start/end addresses of a WAVE file in single-sample units.

Patterns

There are two types of patterns: preset patterns and user patterns.

- **Preset patterns:** Patterns suitable for drum tracks are preset in internal memory, and can be selected for any song.
- **User patterns:** Each song can have up to 100 patterns. When using a pattern in a different song, use the Utility menu commands "Copy Pattern" or "Copy From Song" etc. to copy the pattern. The pattern length can be specified in units of a measure.

Each pattern consists of musical data for one track. It is not possible to create patterns that contain multiple tracks.

You can use these patterns by placing them in a MIDI track ("Put to MIDI Track" page menu command) or by copying them ("Copy to MIDI Track" page menu command). You can also use patterns with the RPPR function of a song.

This is a conceptual diagram of Sequencer mode including the hard disk recording function.

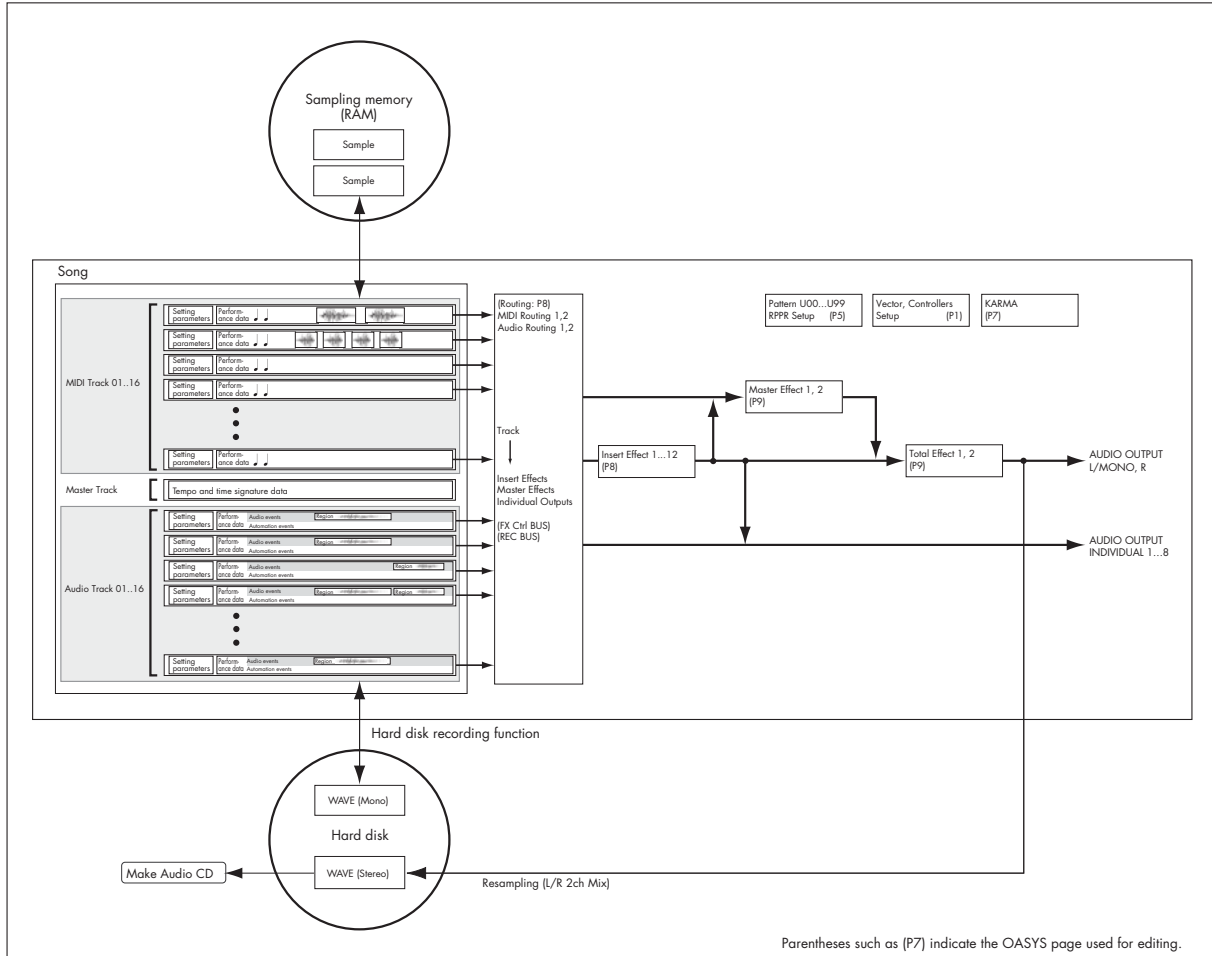

Parentheses such as [P7] indicate the OASYS page used for editing.

Sequencer mode page structure

Page	Explanation
P0: Play/REC	<ul style="list-style-type: none"> • Song playback/recording • Easy editing using the realtime knobs, KARMA sliders, and Tone Adjust • Edit mix parameters such as volume, pan, Play/Mute, and Solo On/Off • Select programs for MIDI tracks • Choose the recording mode • Make settings for sampling, resampling, and audio
P1: EQ/Vector/Controller	<ul style="list-style-type: none"> • EQ adjustments for each track • Function assignments for the SW1 and SW2 switches and realtime knobs 5-8 • Vector Synthesis settings • Assignments for pads 1-8
P2: Track Parameters	<ul style="list-style-type: none"> • Parameter settings for each track (e.g., MIDI channel, OSC selection, pitch settings)
P3: MIDI Filter/Zone	<ul style="list-style-type: none"> • MIDI receive/transmit filter settings for each track • Keyboard zone and velocity zone settings for each track
P4: Track Edit	<ul style="list-style-type: none"> • Track editing
P5: Pattern/RPPR	<ul style="list-style-type: none"> • Pattern recording and editing • RPPR settings
P6:	—
P7: KARMA	<ul style="list-style-type: none"> • Detailed KARMA settings

Page	Explanation
P8: Insert Effect	<ul style="list-style-type: none"> • Insert effect selection, settings, send level to master effects, output routing
P9: Master/Total Effect	<ul style="list-style-type: none"> • Master effect and total effect selection and settings

For details on how to access each mode and page, see “Basic operations” on page 34.

The MIDI transmit/receive settings for each track are made in **MIDI Channel** (P2: Edit- Trk Param, MIDI Ch page).

Sampling or resampling can be performed in Sequencer mode. Refer to the explanations of sampling in Program, Combination, and Sequencer modes.

Since you can apply the OASYS’ internal effects to the external audio inputs, a wide range of possibilities are available.

For details, please see “Effect settings for the audio inputs” on page 190.

Playing Songs

Playback

In order to play back song data in the sequencer, you must first record song data, or load or dump it into the OASYS.

Let's start by loading and playing the demo song data. For more information, see "Listening to the demo songs" on page 4.

1. Press the MODE SEQ switch.

The P0: Play/Rec- MIDI Track Program Select/Mixer page will appear. If it does not, press the EXIT switch and then press the MIDI Prog/Mixer tab.

2. Use "Song Select" to select the song you want to play back.

You can press the Song Select Popup button and choose from a list.

3. Press the SEQUENCER START/STOP switch.

The song you selected in step 2 will begin playing.

Note: The song will begin playing if you press the SEQUENCER START/STOP switch in a page other than P5: Pattern/RPPR. If you press this switch while you're in P5: Pattern/RPPR, the currently-selected pattern will begin playing.

4. During playback, you can press the SEQUENCER START/STOP switch to stop playback.

If you press the START/STOP switch once again, playback will resume from where you stopped.

- Press the LOCATE switch to move to the assigned location.
- Press the PAUSE switch to pause playback. Press the PAUSE switch once again to resume playback.
- Press the <<REW or FF>> switches to rewind or fast-forward. You can use this during playback or while stopped. You can use the "FF/REW SPEED" page menu command to specify the rewind and fast-forward speeds.
- To set the tempo, turn the TEMPO knob or press the TAP TEMPO switch at the desired interval.

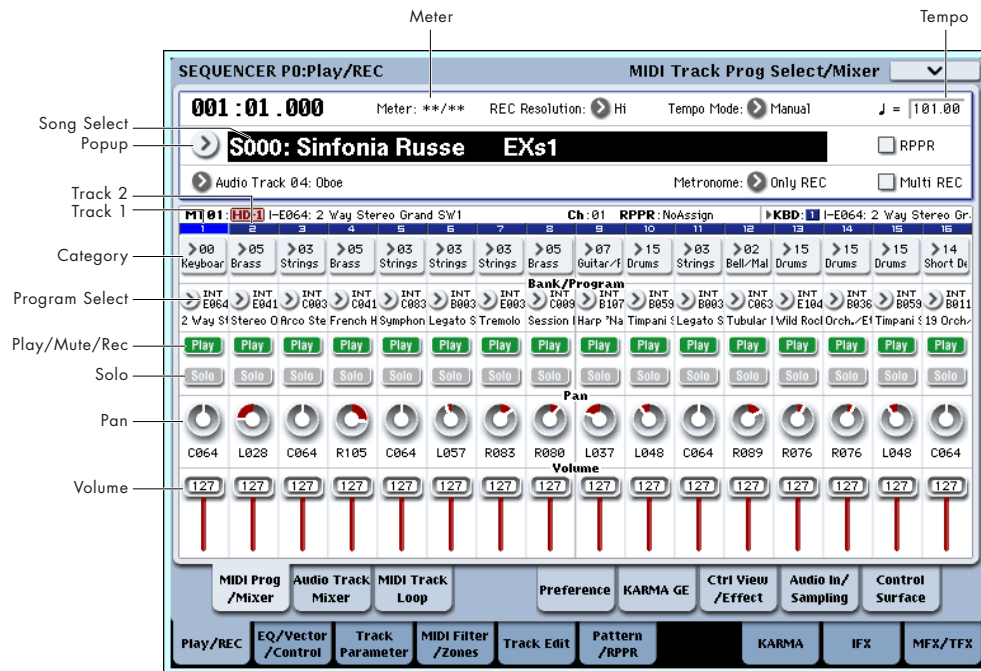
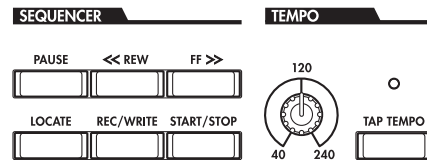

Muting just a specific track/Monitoring just a specific track (Mute/Solo functions)

The OASYS provides a Mute function that lets you silence any of the MIDI tracks 1-16, audio tracks 1-16, or audio inputs (1, 2, 3, 4, S/P DIF L, R), and a Solo function that lets you play back any track by itself. These functions can be used in various ways. For example you can intentionally mute or solo specific

tracks, or listen only to the rhythm section of the previously-recorded tracks while you record new tracks. Let's try out the Mute and Solo functions.

1. Use "Song Select" to select the song that you want to play back.
2. Press the SEQUENCER START/STOP switch.
3. Press track 1 Play/Rec/Mute.

The display will change from **Play** to **Mute**, and the playback of track 1 will no longer be heard. In this

way, the “mute” function allows you to silence a specified track until the track is un-muted.

Press track 2 **Play/Rec/Mute**. The display will change, and the playback of track 2 will also be muted. To cancel muting, press **Play/Rec/Mute** once again.



Tip: Play/Rec/Mute can be controlled from the front panel mixer section, or from the P0– Control Surface page of the LCD screen. (See “The control surface in Sequencer mode” on page 80)

4. Press track 1 “Solo On/Off.”

“Solo” will be highlighted, and this time, only the performance of track 1 will be heard. To play back only a specified track by itself in this way is known as “soling” the track (turning Solo on).

If both Mute and Solo are used, the Solo function will be given priority.

Press track 2 “Solo On/Off.”

The display will change, and you will hear the playback of tracks 1 and 2.

Note: Solo (on) applies to all tracks; MIDI tracks 1–16, audio tracks 1-16, and audio inputs (1, 2, 3, 4, S/P DIF L, R).

If as in this example, you’ve turned Solo on for only MIDI tracks 1 and 2, you will not hear MIDI tracks 3–16, audio tracks 1–16, or the audio inputs (1, 2, 3, 4, S/P DIF L, R).



5. To switch Solo off, press Solo On/Off once again. Press Solo On/Off for both MIDI tracks 1 and 2.

The display will change, and the playback of tracks 1 and 2 will be muted. If the Solo function is turned off for all tracks, playback will be according to the **Play/Rec/Mute** settings.

Tip: Play/Rec/Mute can be controlled from the front panel mixer section, or from the P0– Control Surface page of the LCD screen. (See “The control surface in Sequencer mode” on page 80)

Exclusive Solo

Normally, the Solo function operates in “Exclusive Solo off” mode, where you can solo more than one track at a time (as in the example above). In contrast, “Exclusive Solo on” mode allows only one track to be soloed at a time, making it easy to switch between soloed tracks.

Use the “Exclusive Solo” page menu command to specify how the Solo function will operate.

Exclusive Solo off: You will be able to solo more than one track at a time. The status of a track will change each time you press its Solo On/Off button.

Exclusive Solo on: When you press a Solo On/Off button, only that track will be soloed.

 The **SOLO** setting is not stored when you save the song.

Tip: You can turn Exclusive Solo on/off by holding down the ENTER switch and pressing numeric key 1 (when not in P4 or P5).

The control surface in Sequencer mode

In Sequencer mode, you can use the nine sliders, eight knobs, and sixteen switches of the control surface to edit the sound of each track during playback, to control the KARMA function, or to transmit MIDI messages to external devices.

If you use the control surface to control the mixer during recording, your moves will be recorded, and will be reproduced during playback. If you want to adjust (and record) mixer settings for multiple tracks, use multi-track recording.

As explained below, you use the front panel CONTROL ASSIGN switches to select the functions that will be controlled by the sliders, knobs, and switches.

You can also view the control surface settings in the LCD screen, and edit them there. You may find it convenient to display the P0: Play/REC– Control Surface page first, so that you can watch the settings you’re making from the control surface.

CONTROL ASSIGN:

TIMBRE/TRACK

When TIMBRE/TRACK is selected, the control surface will edit the pan, EQ, effect send, Play/Rec/Mute status, Solo On/Off status, and volume of each MIDI track.

The LEDs at the right of the TIMBRE/TRACK switch indicate whether MIDI tracks 1–8 or 9–16 are currently selected. The sliders, knobs, and switches will control the respective set of tracks.

KNOBS: If you want to view and edit the Pan setting for all eight tracks at once, press the MIXER KNOBS switch to make the INDIVIDUAL PAN LED light, and use the knobs to edit the Pan settings. Conversely if you make the CHANNEL STRIP light, the knobs will control the pan, EQ, and effect sends for a single track. Use the MIX SELECT switches to select the track you want to edit, and use the knobs to control it.

MIX PLAY/MUTE: These switches control the Play/Rec/Mute status. Rec is available if Multi REC is turned on.

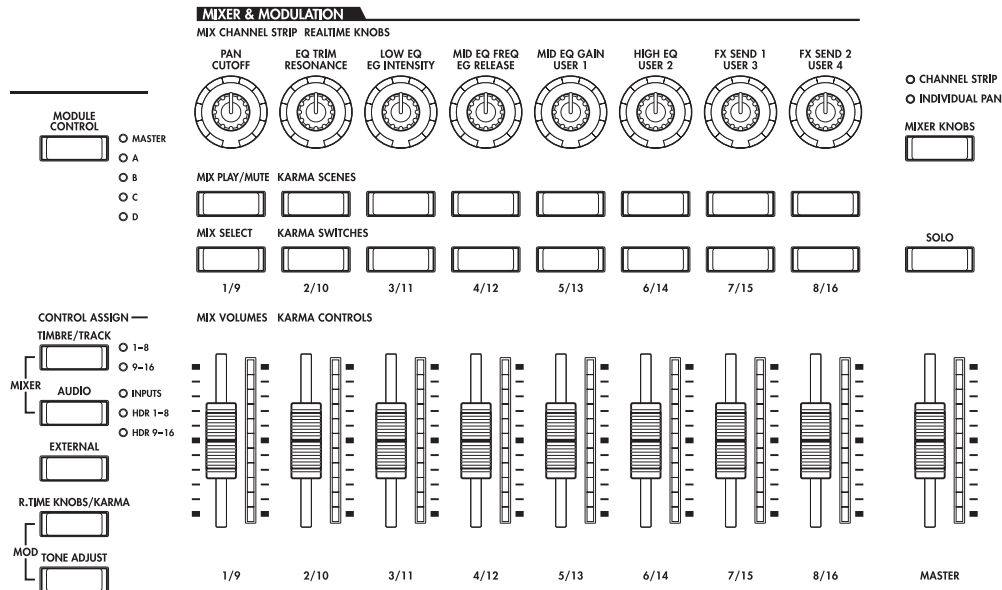

MIX SELECT: Press these buttons to select the current track. This current track applies to the channel strip (when MIXER KNOBS is set to CHANNEL STRIP), and to Tone Adjust.

You can also use these buttons to change the Keyboard/Rec track, so that you can switch between tracks directly from the Control Surface. To do this:

1. Go to the Control Surface tab of the P0: Play page.
2. Set CONTROL ASSIGN to TIMBRE/TRACK, using either the front-panel button or the on-screen tab.
3. Check the box on the right-hand side of the screen, labeled Link KBD/REC Trk to Ctrl Surface.

Now, you'll be able to change the Keyboard/Rec track directly from the Control Surface.

If you press the SOLO switch, the MIX SELECT buttons will control the Solo On/Off status. The Solo behavior will depend on the Exclusive Solo setting.

Note: If any MIDI track, Audio track, or audio input is soloed, the SOLO switch LED will blink.

Tip: To turn Solo off for all tracks, hold down the RESET CONTROLS button and press the SOLO button.

Tip: To turn Mute off for all tracks, hold down the RESET CONTROLS button and press the TIMBRE/TRACK button.

AUDIO

When AUDIO is selected, the control surface will edit the pan, EQ, effect send, Play/Rec/Mute status, Solo On/Off status, and volume of the audio inputs or audio tracks.

The LEDs at the right of the AUDIO switch indicate whether audio inputs (INPUTS), audio tracks 1-8, or audio tracks 9-16 are currently selected. The sliders, knobs, and switches will control the respective set of inputs or tracks.

KNOBS: If you press the MIXER KNOBS switch to make the INDIVIDUAL PAN LED light, the knobs will control the Pan setting of the six inputs, tracks 1-8, or tracks 9-16. If the CHANNEL STRIP LED is lit, the

knobs will control the pan and effect sends for a single input if INPUTS is selected. If HDR 1-8 or HDR 9-16 are selected, the knobs will control the pan, EQ, and effect sends for a single track. Use the MIX SELECT switches to select the input/track you want to control, and use the knobs to control them.

MIX PLAY/MUTE, MIX SELECT: These switches work in the same way as they do for TIMBRE/TRACK, as described above.

EXTERNAL

When EXTERNAL is selected, the control surface is used to transmit MIDI messages to an external MIDI device. For more information, see "0-9e: External" on page 444 of the Parameter Guide.

R.TIME KNOBS/KARMA

When R.TIME KNOBS/KARMA is selected, the sliders and switches of the control surface are used to control the KARMA function. For more information, see "0-9f: RT (Real Time Knobs)/KARMA" on page 445 of the Parameter Guide.

TONE ADJUST

When TONE ADJUST is selected, the control surface is used to temporarily adjust the program used by each MIDI track. For example while you're creating a song, you can use this capability to adjust the sound appropriately for your song without going back to Program mode; you might soften the tone of the bass or speed-up the attack of a strings program, and make these changes happen in realtime while the song plays.

Use **Track** in the right side of the LCD to select the MIDI track you want to adjust.

For more information, see "0-9g: Tone Adjust" on page 447 of the Parameter Guide.

LOCATE settings

You can press the LOCATE switch to move to the registered location. Initially, this will move to 001:01.000.

To change the registered location, use the “Set Location” page menu command. Alternatively, you can register a location during playback by holding down the ENTER switch and pressing the LOCATE switch.

When you select a song, the “LOCATE” setting is automatically initialized to 001:01.000.

For more information, see “Set Location (for Locate Key)” on page 525 of the Parameter Guide.

Loop playback

When recording or playing back a song, you can individually loop the MIDI tracks that are playing.

In the P0: Play/REC– MIDI Track Loop page, check “Track Play Loop” for the MIDI tracks you want to loop, and use “Loop Start Measure” and “Loop End Measure” to specify the starting and ending measure of the region that will play back as a loop.

If you check “Play Intro,” the measures preceding the loop will be played back as an introduction before the loop begins.

If you play back from the first measure with the settings shown in the screenshot below, the specified region of measures will repeat as follows.

Measures	1	2	3	4	5	6	7	8	9	10	11	12	13
Track 1	1	2	3	4	5	6	7	8	5	6	7	8	5
Track 2	-	-	-	-	9	10	9	10	9	10	9	10	9

If “Play Intro” is unchecked, the specified region of measures will repeat as follows.

Measures	1	2	3	4	5	6	7	8	9	10	11	12	13
Track 1	5	6	7	8	5	6	7	8	5	6	7	8	5
Track 2	9	10	9	10	9	10	9	10	9	10	9	10	9



MIDI recording

- You can record up to 200,000 events (e.g., notes), up to 200 songs, and up to 999 measures in each song.
- The maximum timing resolution is 1/192.
- There are sixteen tracks for MIDI performance data, and a master track which controls the time signature and tempo.
- You can perform and record using the KARMA function.
- You can perform and record using the RPPR (Realtime Pattern Play/Recording) function.
- There are 156 built-in preset patterns ideal for drum tracks, and in addition you can create up to 100 user patterns for each song. These patterns can be used as performance data for a song, or with the RPPR function.

Preparations for recording

- ⚠** Before you begin recording, make sure that the memory protect setting in Global mode is turned off. For more information, see “Memory protect” on page 167.

Creating a Song

Before we can begin this example, we need to select an empty song where we can record.

1. Press the MODE SEQ switch to enter Sequencer mode.
2. Choose “Song Select” (e.g., in the P0: Play/REC–MIDI Track Prog Select/Mixer page).
You can press the Song Select Popup button, and choose from a list.
3. Use the numeric keys to input the number of the new song you want to create, and press the ENTER switch. (For example, press the 1 switch and then the ENTER switch.) A dialog box will appear.

If you pressed the Song Select Popup to access the Song No. dialog box, press the desired song number to open the dialog box.

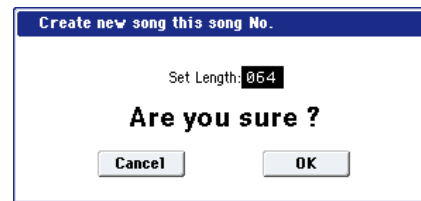

4. Press the OK button to create the song.

Use “Set Length” to input the desired number of measures and press the OK button. You can change the number of measures later if desired. For more information, see “Set Song Length” on page 541 of the Parameter Guide.

If you created a song by opening the Song No. dialog box, press the OK button in the Song No. dialog box to close it.

Track settings

Since we’re going to record a new song in this example, we will start by explaining how to assign a program to each MIDI track, and make basic settings such as volume.

For details on audio tracks, refer to “Audio recording” on page 96.

1. Assign a program to each MIDI track.

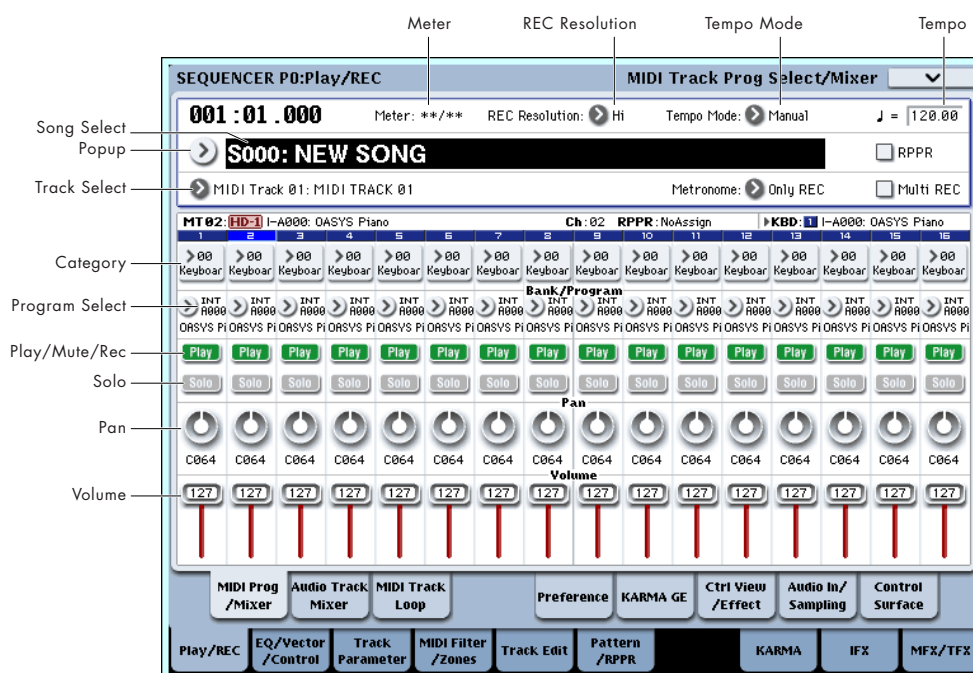

Use “Program Select” (P0: Play/REC– MIDI Track Prog Select/Mixer page) to assign a program to each MIDI track.

At this time you can press the “Category” popup and select programs by category.

You can copy various settings from Programs or Combinations, including effects, KARMA settings, Tone Adjust, and so on.

When assigning a program, you can use “Track Select” to select the track for which you are making assignments, and try playing the sound.

2. Set the pan and volume of each MIDI track.

Pan sets the pan of each track, and **Volume** sets the volume of each track.

3. Specify the tone generator and MIDI channel that will be played by each MIDI track.

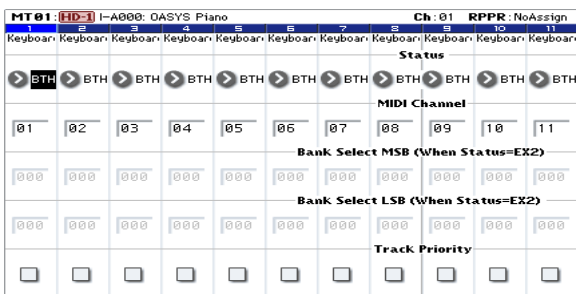

In the P2: Track Parameters– MIDI page, **Status** specifies whether each track will sound the internal tone generator or an external tone generator. **MIDI Channel** specifies the MIDI channel for each track.

Normally when using the OASYS as a 16-timbre sound module, you will select INT or BTH.

In general, you should set **MIDI Channel** to different channels 1–16 for each track. Tracks that are sent to the same MIDI channel will sound simultaneously when either is recorded or played.

Status INT: During playback, the OASYS’ internal tone generator will play the MIDI data recorded on that track. When you operate the OASYS’ keyboard or controllers, you will be playing and controlling the track selected by “Track Select.” MIDI data will not be transmitted to an external device.

Status EXT, EX2, BTH: During playback, the MIDI data recorded on that track will be transmitted from MIDI OUT to play an external sound module. When you operate the OASYS’ keyboard or controllers, MIDI data will be transmitted to play and control the external sound module selected by “Track Select.” (The MIDI channel of the external tone generator must be set to match the **MIDI Channel** of OASYS tracks that are set to EXT, EX2 or BTH.)

If **Status** is set to BTH, both the external tone generator and internal tone generator will be sounded and controlled.

4. Adjust the effect settings.

Make settings for each effect in P8: Insert Effect and P9: Master/Total Effect.

For more information, see “Using effects in Combinations and Songs” on page 187, “Sequencer P8: Insert Effect” on page 509 of the Parameter

Guide, and “Sequencer P9: Master/Total Effect” on page 521 of the Parameter Guide.

5. Set the tempo and time signature.

To set the tempo, you can turn the TEMPO knob or press the TAP TEMPO switch at the desired interval. Alternatively, you can select “♩ (Tempo)” in the P0: Play/REC– MIDI Track Prog Select/Mixer page (or similar page), and use the VALUE controllers to set the tempo. Set “Tempo Mode” to Manual.

Next you will set the time signature. In this example, we’ll explain how to set the time signature using the “Meter” field. Normally, you specify the time signature before recording the first track, and then begin recording.

a) Press the SEQUENCER REC/WRITE switch, and set “Meter” to **/**.

b) Press **/** to highlight it, and use the VALUE controllers to set the time signature.

c) Press the SEQUENCER START/STOP switch to begin recording. When the pre-count has ended and Locate reaches 0001:01:000, press the SEQUENCER START/STOP switch to stop recording. The time signature you specified has been recorded on the Master track.

If you press the SEQUENCER START/STOP switch during the pre-count, the time signature won’t be recorded.

6. Set the “REC Resolution” if necessary. When you realtime-record on a MIDI track, this parameter specifies how the timing of the recorded MIDI data will be corrected. The timing will also be corrected when you realtime-record automation data on an audio track. (Already-recorded data will not be corrected.)

For example, let’s suppose that you realtime-recorded some eighth notes but your timing was not quite perfect, as shown in part 1 of the illustration below. If “REC Resolution” were set to ♩ when you recorded, the timing would automatically be corrected as shown in part 2 of the illustration. If “REC Resolution” is set to Hi, the notes will be recorded with the timing at which you play them.



7. Make other settings as necessary.

Make settings for the KARMA function (P7: KARMA), MIDI filtering (P3: MIDI Filter/Zone), etc.

You may also wish to use Tone Adjust to adjust the sound. (See “TONE ADJUST” on page 81)

When you are finished making these settings, the basic setup is complete. You can now record as described under “Recording procedure” on page 100

Saving your song parameter settings

The song parameter settings you make here can be saved as a template. If you use these settings frequently, you can simply load one of the templates you've saved. For more information, see "Save Template Song" on page 525 of the Parameter Guide.

Template songs

Loading a template song is an easy way to make settings appropriate for a particular musical style. You can also assign a drum pattern to a track at the same time.

1. In the P0: Play/REC page (or a similar page), press the page menu button and choose "Load Template Song."

A dialog box will appear.

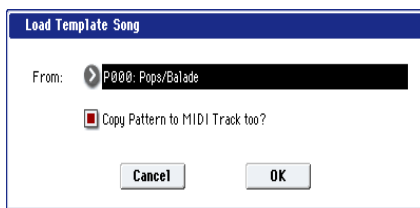

2. In the "From" field, choose the template song you want to load.
3. If you check "Copy Pattern to MIDI Track too?", a dialog box for copying a pattern will automatically appear after you execute "Load Template Song."

If you execute without checking this, only the template song you selected in step 2 will be loaded.

4. Press the OK button to load the template song, or press the Cancel button if you decide to cancel.

When you execute this operation, song settings other than MIDI Track Loop and RPPR will be copied.

If you executed this operation with "Copy Pattern to MIDI Track too?" checked in step 3, the "Copy Pattern To MIDI Track" dialog box will appear.

This dialog box is the same as the one that appears for the "Copy To MIDI Track" page menu command.

5. In the "Pattern" field, select the pattern that you want to copy. You can press the SEQUENCER START/STOP switch to play back the selected pattern.

In the To "MIDI Track" field, select the copy-destination track.

In the "Measure" field, specify the starting measure of the copy-destination.

Note: In each of the sixteen preset template songs, track 1 is always assigned to a program of the Drums category. (In preset template songs P02, P04, P08, and P15, programs of the Drums category are assigned to more than one track.)

Following the pattern name for each of the 156 preset patterns, the musical style and the name of the most suitable Drums category program are partially displayed. (Refer to VNL)

By loading a drums track and the corresponding preset pattern, you can instantly set up a drum track appropriate for each preset template song.

6. To execute, press the OK button.

When you execute this operation, "Measure" will count up automatically. You can then copy another pattern if desired. When you're finished, press the Exit button.

Recording MIDI in real-time

When you've finished with "Preparations for recording," you can start recording.

This is a method of recording in which your playing on the keyboard and your operations of controllers such as the joystick are recorded in realtime. This method of recording is normally used one track at a time, and is called single track recording.

As an alternative, multitrack recording allows you to simultaneously record multiple channels of data onto multiple tracks. This is the method you will use when using the RPPR function and the KARMA function to record multiple tracks of musical data at once, or when you playback existing sequence data on an external sequencer and record it onto OASYS's sequencer in realtime.

Recording setup

In P0: Play/REC- Preference page **Recording Setup**, select the realtime recording method you want to use.

Overwrite

With this method, the musical data previously recorded on a track is overwritten by the newly recorded data. When you perform overwrite recording on a previously-recorded track, its musical data will be deleted and replaced by the newly recorded data.

Normally you will use this method to record, and then modify the results by using other types of realtime recording or MIDI event editing.

1. Use "Track Select" to select the track that you want to record.
2. Set the Recording Setup to Overwrite.

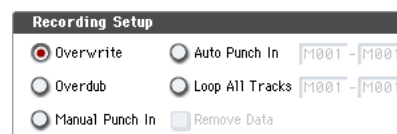

3. In "Location," specify the location at which you wish to begin recording.
4. Press the SEQUENCER REC/WRITE switch, and then press the SEQUENCER START/STOP switch.

If the **Metronome Setup** is still set to the default settings, the metronome will sound for a two-

measure pre-count, and then recording will begin. Play the keyboard and move controllers such as the joystick to record your performance.

5. When you finish playing, press the SEQUENCER START/STOP switch.

Recording will end, and the location will return to the point at which you begin recording.

If you press the PAUSE switch instead of the SEQUENCER START/STOP switch, recording will pause. When you press the PAUSE switch once again, recording will resume. When you are finished, press the SEQUENCER START/STOP switch to stop recording.

Overdub

With this method, the newly recorded musical data is added to the existing data.

When you perform overdub recording on a previously-recorded track, the newly recorded data will be added to the previously-recorded data.

It is best to select this mode if you will be recording additional control data, recording a drum pattern, or recording the tempo in the master track. With this mode, data can be added without erasing the existing performance data.

1. Use "Track Select" to select the track that you want to record.
2. Set the Recording Setup to Overdub.

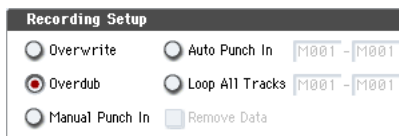

3. For the rest of the procedure, refer to steps 3–5 of "Overwrite."

Manual punch-in

While the song is playing, you can press the SEQUENCER REC/WRITE switch or a connected pedal switch at the desired location to start or stop

recording. With this method, the musical data previously on the track is overwritten by the newly recorded data.

1. Use "Track Select" to select the track that you want to record.

2. Set the Recording Setup to Manual Punch In.

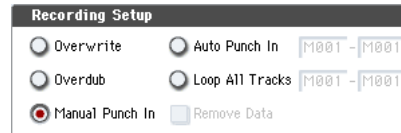

3. In "Location," specify a location several measures earlier than the point at which you wish to begin recording.

4. Press the SEQUENCER START/STOP switch. Playback will begin.

5. At the point at which you wish to begin recording, press the SEQUENCER REC/WRITE switch.

Recording will begin. Play the keyboard and operate controllers such as the joystick to record your performance.

6. When you finish recording, press the SEQUENCER REC/WRITE switch.

Recording will end (playback will continue).

Note: Instead of pressing the SEQUENCER REC/WRITE switch in steps 5 and 6, you can use a foot switch connected to the ASSIGNABLE SWITCH jack.

Set the Global P2: Controllers/Scales page "Foot Switch Assign" to Song Punch In/Out.

7. Press the SEQUENCER START/STOP switch.

Playback will stop, and you will return to the location that you specified in step 3.

Auto punch-in

First you must specify the area that will be re-recorded. Then recording will occur automatically at the specified area. With this method, the musical data previously on the track is overwritten by the newly recorded data.

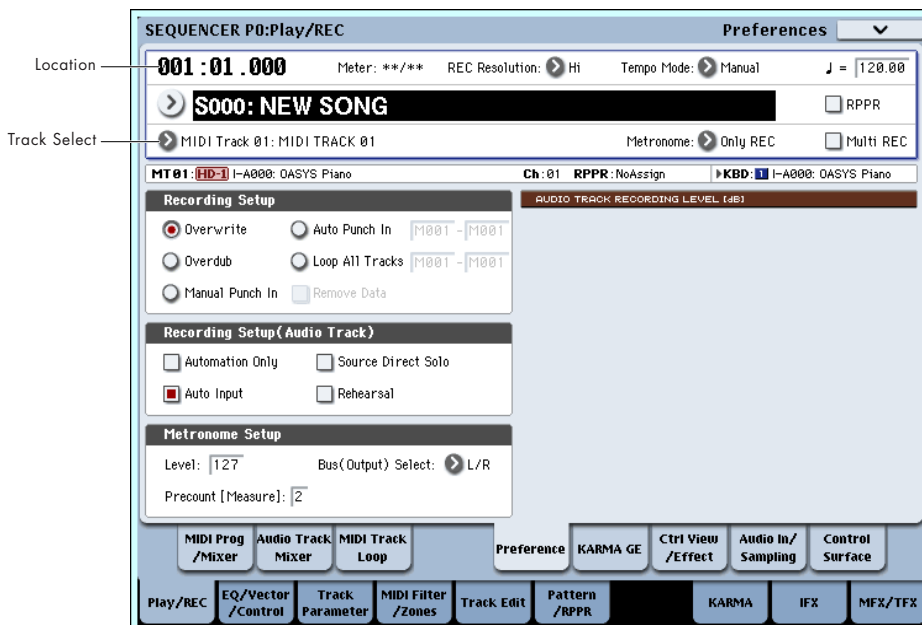

1. Use “Track Select” to select the track that you want to record.
2. Set the Recording Setup to Auto Punch In.

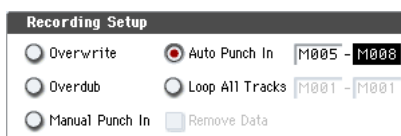

3. In “M (Auto Punch In Start Measure), “M (Auto Punch In End Measure)” specify the area that you wish to record.

For example if you specify M005–M008, recording will occur only from measure 5 to measure 8.

4. In “Location,” specify a location several measures earlier than the point at which you wish to begin recording.
5. Press the SEQUENCER REC/WRITE switch, and then press the SEQUENCER START/STOP switch. Playback will begin.

When you reach the starting location you specified in step 3, recording will begin. Play the keyboard and operate controllers such as the joystick to record your performance. When you reach the ending location you specified in step 3, recording will end. (Playback will continue.)

6. Press the SEQUENCER START/STOP switch. Playback will stop, and you will return to the location you specified in step 4.

Loop All Tracks

This method lets you continue recording as you add musical data.

The specified region can be recorded repeatedly. This is ideal when recording drum phrases, etc.

1. Use “Track Select” to select the track that you want to record.
2. Set the Recording Setup to Loop All Tracks.

If Multi REC is checked, it will not be possible to select Loop All Tracks.

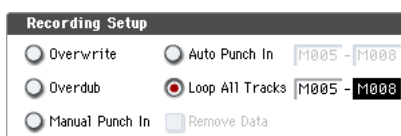

3. In “M (Loop Start Measure), “M (Loop End Measure)” specify the area that you wish to record.

For example if you specify M004–M008, recording will occur repeatedly (as a loop) from measure 4 to measure 8.

4. In “Location,” specify a location several measures earlier than the point at which you wish to begin recording.
5. Press the SEQUENCER REC/WRITE switch, and then press the SEQUENCER START/STOP switch. Playback will begin. When you reach the starting location you specified in step 3, recording will begin. Play the keyboard and operate controllers such as the joystick to record your performance.

When you reach the ending location you specified in step 3, you will return to the starting location, and continue recording.

The musical data that is loop-recorded will be added to the previously-recorded data.

6. You can also erase specific data even while you continue loop recording.

If you press the SEQUENCER REC/WRITE switch during loop recording, all musical will be removed from the currently selected track as long as you continue pressing the switch.

By checking the “Remove Data” check box you can erase only the specified data. During loop recording, press the note that you wish to delete, and only the data of that note number will be deleted from the keyboard as long as you continue pressing that note.

Similarly, bender data will be deleted as long as you tilt the joystick in the X (horizontal) direction, and after touch data will be deleted as long as you apply pressure to the keyboard.

When you are once again ready to record musical data, uncheck the “Remove Data” check box.

7. Press the SEQUENCER START/STOP switch.

Playback will end, and you will return to the recording start location that you specified in step 4. If Loop All Tracks is selected, normal playback will be looped as well.

Multi (multitrack recording)

Multitrack recording allows you to simultaneously record onto multiple tracks, each with a different channel.

1. In the upper right of the LCD screen, check “Multi REC.”
2. Make the desired Recording Setup settings.

You can record using Overwrite, Overdub, Manual Punch In, or Auto Punch In.



3. Use “Location” to specify the measure at which recording will begin.
4. Press the SEQUENCER REC/WRITE switch.
5. For the track you want to record, press Play/Rec/Mute to make it indicate Rec.
6. Press the SEQUENCER START/STOP switch.

With the default settings for Metronome Setup, the metronome will sound for a two-measure pre-count, and then recording will begin. Now you can perform on the keyboard and controllers, and use the KARMA or RPPR functions if desired.

7. Press the SEQUENCER START/STOP switch. Playback will stop, and you will return to the location specified in step 4.

An example of realtime recording

In this example, we'll assign a drum program to MIDI Track 01 and create the following one-measure drum phrase.



1. Create a new song, and specify a drum program for MIDI Track 01. Use "Track Select" to select MIDI Track 01, and verify that you hear a drum program.

2. Go to the P0: Play/REC- Preference page. In Recording Setup, specify "Loop All Tracks" and set it to M001-M001.

For more information, see "Loop All Tracks" on page 87.

With this setting, measure 1 will be recorded repeatedly. The newly recorded data will be added at each pass.

3. Set "REC Resolution" to ♩.

4. Press the SEQUENCE REC/WRITE switch, and then the START/STOP switch.

The metronome will sound a two-measure count-down, and then recording will begin.

5. As shown in the musical example printed above, start by playing the C3 note of the keyboard to record the bass drum for one measure.

6. Next, play the E3 note of the keyboard to record the snare for one measure, and then the F#3 note to record the hi-hat.

7. Press the SEQUENCER START/STOP switch to stop recording.

8. Play back the result, and listen to the drum performance you recorded.

Press the SEQUENCER START/STOP switch. When you've finished listening, press the START/STOP switch once again to stop playback.

9. If you're not satisfied with the result, press the COMPARE switch to return to the state prior to recording, and then re-record from step 4.

Note: When you're finished recording, change the Recording Setup back to the normally-used "Overwrite" (P0: Play/REC- Preference page).

In addition, access the P0: Play/REC- MIDI Track Loop page, check "Track Play Loop" for MIDI Track 01, and set the "Loop Start Measure" and "Loop End Measure" to 001. When you play back, MIDI track 01 will repeatedly play the first measure.

MIDI step recording

Step recording is the recording method in which you specify the duration and strength of each note, and use the keyboard to specify the pitch of each MIDI note. You can use the Rest button and Tie button of the dialog box to input rests and ties.

Step recording is useful when you want to create mechanically precise beats, or when you need to record a phrase that would be difficult to play by hand "in realtime," or when you find it difficult to play extremely complicated or rapid passages.

An example of step recording

In this example, we'll assign a bass program to MIDI Track 02 and step-record the following two-measure bass phrase.



1. Specify a bass program for MIDI Track 02. Use "Track Select" to select MIDI Track 02, and verify that you hear a bass program.

2. Access the P4: Track Edit- Track Edit page.

3. Set "From Measure" to 001.

With this setting, step recording will begin from measure 1.

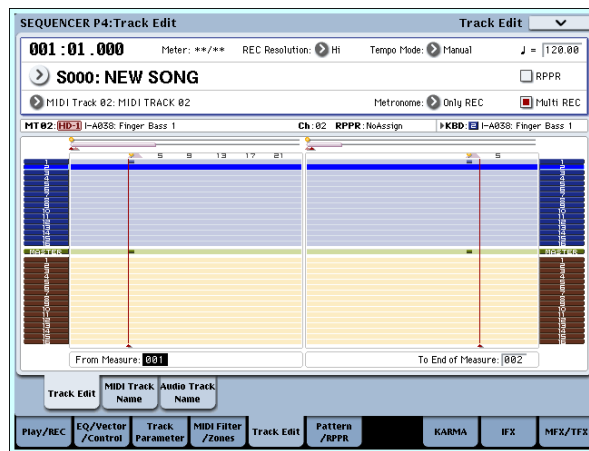

4. Press the page menu button, and press page menu command "MIDI Step Recording."

A dialog box will appear.

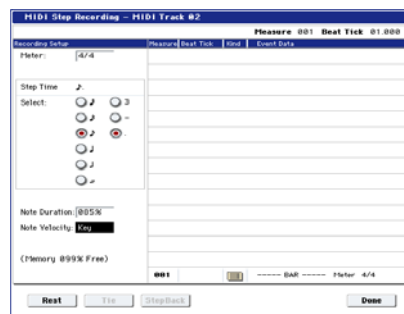

5. In "Step Time," use "Select" to specify the basic timing value at which you will input notes and rests.

Input the first C3 note as . (dotted eighth note).

Use the radio button at the left to select .

You can choose from the range (whole note)– (32nd note).

Input a dotted note by selecting “.” with the radio buttons at right.

You can specify “3” to input a triplet. If you want to use the unmodified length of the note that’s selected at the left, choose “-”.

“Note Duration” indicates the length that the note itself will sound. Smaller values will produce a staccato note, and larger values will produce a legato note. For this example, leave this setting unchanged.

“Note Velocity” is the velocity (playing strength), and larger values will produce a louder volume. Set this to Key.

If you select Key for this parameter, the velocity with which you actually play the keyboard will be input.

6. On the keyboard, press and then release the first C3 note that you want to input.

The data you input will appear in the LCD screen as numerical values. In the upper right, Measure 001 Beat Tick 01.000 will change to Measure 001 Beat Tick 01.144. The next note you input will be placed at this location.

7. Input the remaining notes as described in steps 5 and 6. (You’ve already input the first C3 note.)

In addition to the methods described in steps 5 and 6, you can also use the following input methods.

- To input a rest, press the Rest button. This will input a rest of the “Step Time” value.
- To modify the length of a note, you can modify the “Step time” value before you input the note. However if you want to extend the length (tie) of the note, press the Tie button. At this time, the previously-input note will be extended by the “Step time” length.
- To delete a note or rest that you input, press the Step Back button. The previously-input note will be deleted.
- To input a chord, simultaneously press the notes of the desired chord. Even if you do not press them simultaneously, notes that are pressed before you fully remove your hand from all keys on the keyboard will be input at the same location.
- If you want to verify the pitch of the note that you will input next, press the PAUSE switch. In this state, playing a key will produce a sound, but will not input a note. Press the PAUSE switch once again to cancel the record-pause state, and resume inputting notes.

Note	Step Time: Select	Step Time: . 3 -	Key, Button	Measure/ Beat Tick
C3		.	C3 key	001 / 01.000
G3		-	G3 key	001 / 01.144
		-	Rest button	001 / 02.000

Note	Step Time: Select	Step Time: . 3 -	Key, Button	Measure/ Beat Tick
C4		-	C4 key	001 / 02.096
		-	Rest button	001 / 02.144
C4		-	C4 key	001 / 03.048
D3		-	D3 key	001 / 03.096
Eb3		-	Eb3 key	001 / 04.000
E3		-	E3 key	001 / 04.096
F3		-	F3 key	002 / 01.000
		-	Rest button	002 / 01.048
C3		-	C3 key	002 / 01.144
		-	Rest button	002 / 02.000
F2		-	F2 key	002 / 02.096
Tie		-	Tie button	002 / 03.000
F2		-	F2 key	002 / 03.096
		-	Rest button	002 / 03.144
A2		-	A2 key	002 / 04.000
A3		-	A3 key	002 / 04.096
		-	Rest button	002 / 04.144

8. When you are finished recording, press the Done button.

Press the SEQUENCER START/STOP switch to play back.

Access the P0: Play/REC– MIDI Track Loop page, check **Track Play Loop** for MIDI Track 02, set **Loop Start Measure** to 001, and **Loop End Measure** to 002. MIDI track 02 will play measures 1–2 repeatedly.

9. If you’re not satisfied with the result, press the COMPARE switch to return to the state prior to recording, and then re-record from step 4.

When you begin step recording, all data in the MIDI track that follows the measure where you began recording will be erased. You need to be aware of this if you begin step recording from a measure mid-way through the song.

If you want to copy data into a measure that already contains data, perform step recording in an empty MIDI track, and use the **Move Measure** or **Copy Measure** menu commands. For more information, see “Copy Measure” on page 546 of the Parameter Guide, and “Move Measure” on page 546 of the Parameter Guide.

If you want to edit or add to the recorded data, you can use the **MIDI Event Edit** function. For more information, see “Event Edit” on page 554 of the Parameter Guide.

Recording the sound of a Combination or Program

Here's how you can easily copy the settings of a Combination or Program, and then record using that sound.

When you're performing in Program or Combination mode, you can use the Auto Song Setup function to automatically set up the settings of that program or combination into a song. Alternatively, you can use the Sequencer mode page menu commands "Copy From Combi" and "Copy from Program" to set up a song in a similar way.

Auto Song Setup function

The explanation of the Auto Song Setup function given here follows the procedure from Combination mode.

1. **Enter Combination mode.**
2. **If you change any of the settings in the combination in the Combination P0: Play- Prog Select/Mixer page.**
Such as panning, volume and KARMA setting you must first save the edited settings using "Update Combination" or "Write Combination."
3. **Hold down the ENTER switch and press the SEQUENCER REC/WRITE switch.**
The "Setup to Record" dialog box will appear.
4. **Press the OK button to perform the Auto Song Setup.**
The OASYS will automatically switch to Sequencer mode, and the combination's settings will be applied to a new song. The new song will be the first unused song.
5. **You will automatically enter record-ready mode, and the metronome will begin sounding according to the settings in P0: Play/REC- Preference page.**
For more information, see "0-5d: Metronome Setup" on page 431 of the Parameter Guide.
6. **Press the SEQUENCER START/STOP switch, and realtime recording will begin.**

When you're finished recording, press the START/STOP switch once again.

Settings that are automatically copied from the combination

The settings that will be automatically copied will be the same settings as if you had executed the page menu command "Copy From Combi," and had made the following settings in the dialog box.

IFXs-All, MFXs and TFXs checked

Multi REC Standby checked

For more information, see "Copy from Combination" on page 526 of the Parameter Guide

Settings that are automatically copied from the program

The settings that will be automatically copied will be the same settings as if you had executed the page menu command "Copy From Program," and had made the following settings in the dialog box.

IFXs-All, MFXs and TFXs checked

with KARMA checked

"To" set to MIDI Track 01

"KARMA Module" set to A

For more information, see "Copy From Program" on page 526 of the Parameter Guide

Setup in Sequencer mode (Copy From Combination/Copy From Program)

In Sequencer mode, you can use the "Copy From Combi" and "Copy From Program" page menu commands to set up a sequencer song based on a combination or program. In this example, we'll explain how to set up a song based on a combination.

Note: Make sure that the global MIDI channel (Global P1: MIDI- MIDI page, MIDI Channel) is set to 01.

1. **Create a new song.**
For more information, see "Creating a Song" on page 83.
2. **Select the page menu command "Copy From Combi."**

A dialog box will appear.

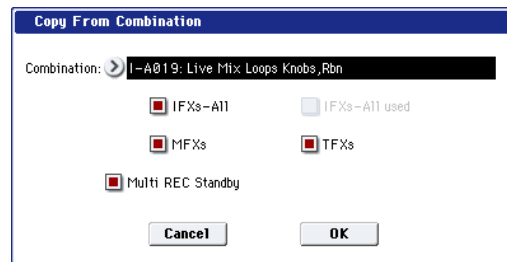

Select the program or combination that you want to copy (i.e., the copy source).

We will copy the effect settings of the combination as well, so check the IFXs-All, MFXs and TFXs check boxes.

Check **Multi REC Standby**. The **Status** will be automatically set to REC for the MIDI tracks needed to record that combination.

Press the OK button to execute the copy.

Notice that when you execute this command, the **Play/Rec/Mute** setting of each track will be set automatically. The **Multi REC** check box will be checked.

3. **Begin recording.**
Press the LOCATE switch to set the location to 001:01.000.
Press the SEQUENCER REC/WRITE switch, and then press the SEQUENCER START/STOP switch.
Note: If you play the keyboard during the pre-count before recording, the phrase generated by the KARMA function will start playing the moment recording begins. Record your performance.
4. **When you are finished performing, press the SEQUENCER START/STOP switch.**

If you made a mistake or want to re-record, you can use the Compare function (press the COMPARE switch) to re-record as many times as you want.

(The **Multi REC** check box will be unchecked when you use Compare, so you will need to check it again.)

Recording multiple MIDI tracks from an external sequencer

1. Make sure that the MIDI OUT of your external sequencer is connected to the MIDI IN of the OASYS.

If it is not connected, turn off the power, make the connection, and then turn the power on.

For more information, see “MIDI applications” on page 1001 of the Parameter Guide.

2. In the Global P1: MIDI– MIDI page, set MIDI Clock to External MIDI. With this setting, the OASYS will synchronize to MIDI clock messages from your external sequencer.

Make sure that Receive Ext. Realtime Commands is checked.

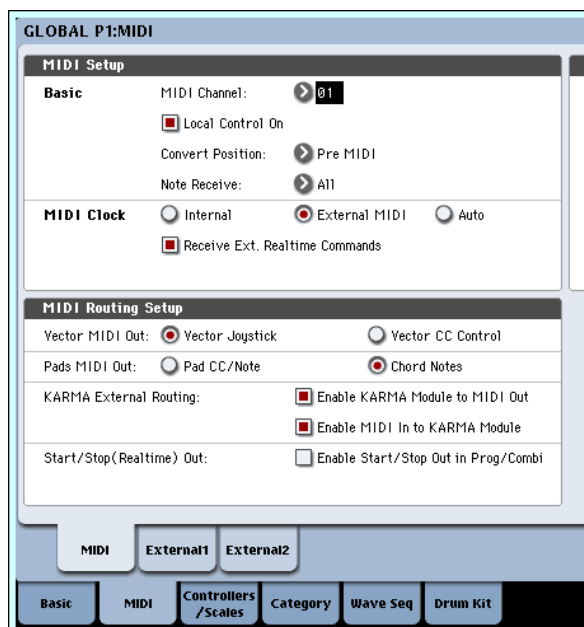

3. Create a new song in Sequencer mode, and in the P0: Play/REC– Preference page, check the Multi REC check box. Set Recording Setup to Overwrite.

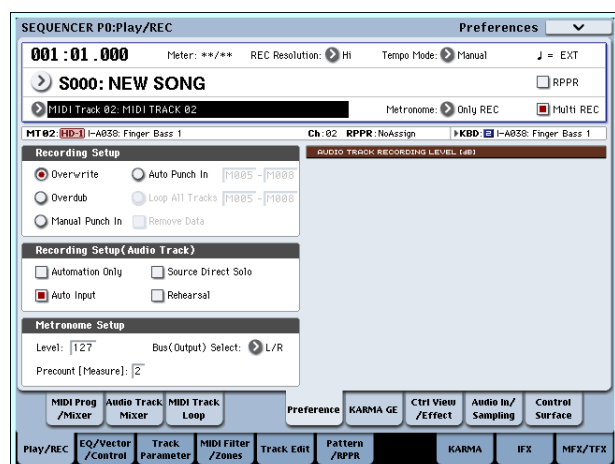

4. Press Play/Rec/Mute to select “REC” for the tracks you want to record.

For the tracks you don’t want to record, select Play or Mute.

Tip: You can also control the Play/Rec/Mute setting from the front panel mixer section, or from the P0–Control Surface page of the LCD screen. (See p.42 “The control surface in Sequencer mode”)

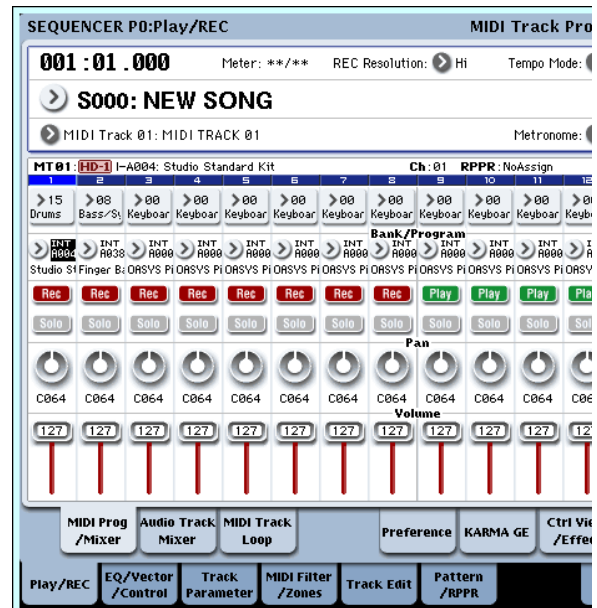

5. In the P2: Track Parameters– MIDI page, use MIDI Channel to specify the MIDI channel of each track.

Set the MIDI channel of each OASYS track to match the MIDI channel of each external sequencer track. Data of the matching channel will be recorded on each OASYS track.

Make sure that Status is set to INT or BTH.

6. Press the LOCATE switch to set the location to 001:01.000.
7. Press the SEQUENCER REC/WRITE switch to enter record-standby mode.
8. Start your external sequencer.

The OASYS’ sequencer will automatically begin recording when it receives the MIDI Start message transmitted by your external sequencer.

9. When playback has ended, stop your external sequencer.

The OASYS’ sequencer will automatically stop recording when it receives the MIDI Stop message transmitted by the external sequencer. You can also stop recording by pressing the SEQUENCER START/STOP switch of the OASYS.

After this, you can play back the newly recorded sequence:

10. In the Global P1: MIDI page, set MIDI Clock to Internal.
11. Set “Tempo Mode” to Auto.

12. Press the SEQUENCER START/STOP switch to play back.

Note: If the correct sounds are not selected when you start playing back, you may be able to solve the

problem by using the page menu command “MIDI Event Edit” (P4: Track Edit) to re-specify the Program Change data.

Recording System Exclusive events

Exclusive messages received from an external MIDI device or the parameter changes produced when you edit a MIDI track parameter, audio track parameter or effect parameter can be realtime-recorded on any MIDI track.

During playback, the exclusive messages you recorded will control the track parameters and effect parameters of the song, and can be sent to external MIDI devices.

Note: You can use the page menu command “Put Effect Setting to MIDI Track” to insert an exclusive event containing the parameter settings for an insert effect, master effect or total effect into the desired location of a track, so that these settings will automatically switch during playback.

 GM, XG, and GS exclusive messages can be recorded on a track, but the OASYS's tone generator will not respond to these messages.

Recording internal parameter changes

You can use SysEx for automation of internal OASYS effects and Program parameters.

As an example, let's record a short phrase on track 1, add an insert effect, and then record parameter changes for that effect on an unused track.

Note: In order to record system exclusive messages, make sure that the Global P1: MIDI- MIDI setting “Enable Exclusive” is checked.

1. Select the desired program for MIDI track 1, and route it to IFX1. Then record a phrase of about sixteen measures.
- In the P0: Play/REC- MIDI Track Prog Select/ Mixer page, use “Program Select” to select the desired program for MIDI Track 01.
- In the P8: Insert Effect- MIDI Routing1 page, route the MIDI Track 01 Bus Select (IFX/Indiv. Out Assign) to IFX1. Then in the P8: Insert Effect- Insert FX page, select the desired effect for IFX1.
- Select MIDI Track 01 in “Track Select.” Then press the SEQUENCER REC/WRITE switch and then the START/STOP switch, and record a phrase of about sixteen measures.

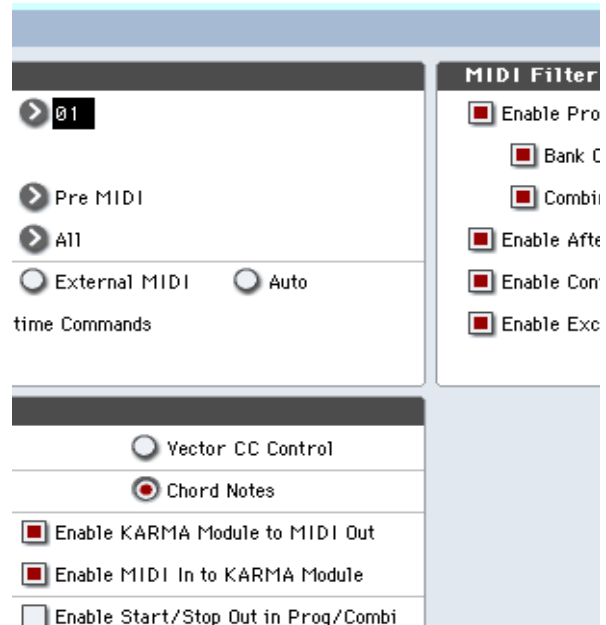

2. Select MIDI Track 09 in “Track Select,” and record parameter changes as desired.

Note: For this example, select an empty track. If you want to record onto a MIDI track that already contains data, set the P0:Play/REC- Preference page Recording Setup to “Overdub,” as described on page 86.

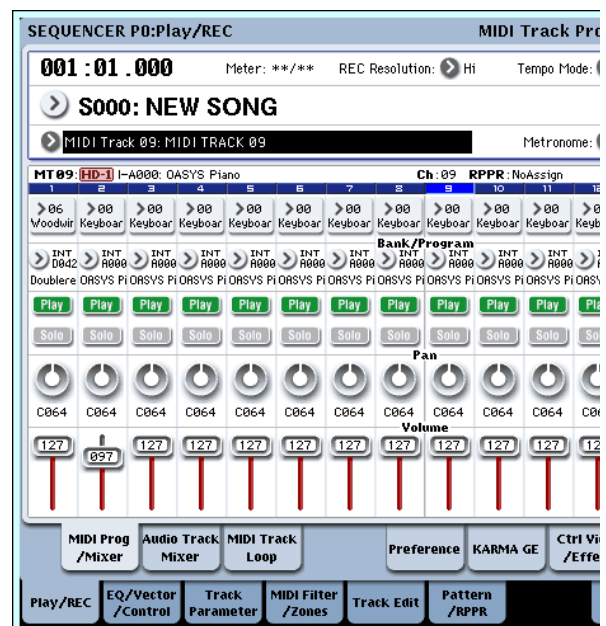

- Select MIDI Track 09 in “Track Select.” Then press the SEQUENCER REC/WRITE switch and then the START/STOP switch, and begin recording.
- At the appropriate time while recording, adjust the parameter(s) that you want to realtime-record.

Select another effect for IFX1 in the P8: Insert Effect–Insert FX page, and edit the effect parameter values, or use the P0: Play/REC–Control Surface page Tone Adjust controls to edit the sound in realtime.

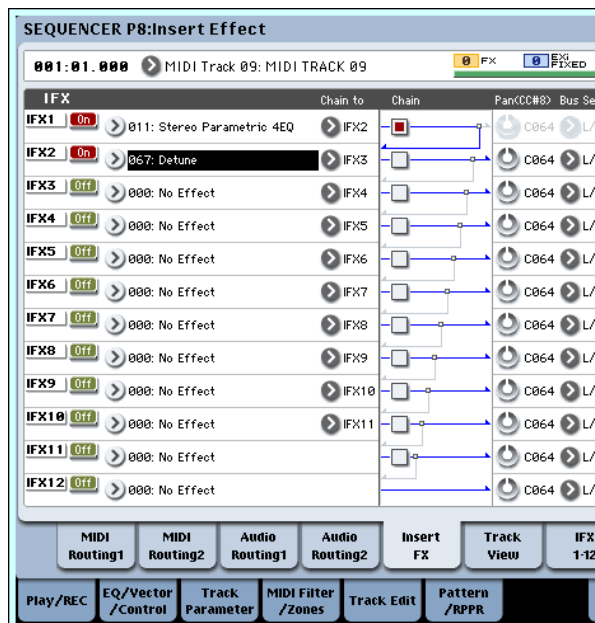

Note: For details on the effects parameters that you can record in real-time, please see “System Exclusive events supported in Sequencer mode” on page 560 of the Parameter Guide.

3. Stop recording.

Note: Exclusive messages are always recorded on the current track selected by “Track Select.” In this example, they are recorded on MIDI track 9.

Note: In the MIDI event edit screen you can view the recorded exclusive events and their location. Exclusive events are displayed as “EXCL”.

To view these events, go to the P4: Track Edit–Track Edit page, and select the page menu command “MIDI Event Edit.” Then in the Set Event Filters dialog box, check Exclusive and press the OK button.

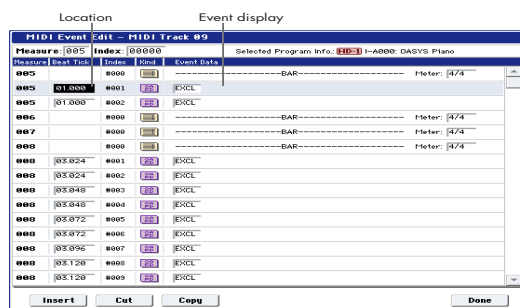

Exclusive events cannot be changed to a different type of event. Nor can other events be changed into exclusive events.

- If you go to the page (e.g., P8: Insert Effect) that shows the parameters you adjusted in realtime, you can watch the recorded changes be reproduced while the song plays back.

Exclusive messages that can be recorded in real-time

The following exclusive messages can be recorded in real-time:

- Exclusive messages received from an external MIDI device
- Parameter changes in Sequencer mode (see “System Exclusive events supported in Sequencer mode” on page 560 of the Parameter Guide)
- Master Volume universal exclusive messages assigned to the foot pedal or a knob

Recording patterns

Recording and editing patterns

You can record patterns in either of two ways; realtime recording or step recording. However, pattern realtime recording differs from song realtime recording in that you can use only Loop type recording.

You can edit patterns by using Event Edit operations to modify the recorded data or insert new data. You can also use the “Get From MIDI Track” page menu command to convert a desired region of performance data from a MIDI track into a pattern. Conversely, you can use the “Put to MIDI Track” or “Copy to MIDI Track” page menu commands to place or copy the performance data from a pattern into a MIDI track.

Recording patterns in real-time

Here’s how you can use realtime recording to create a pattern. User patterns can be accessed by the RPPR function in the same way as preset patterns, and can be copied to or placed in a song. Playback data from a track can also be copied to a pattern.

When realtime-recording a pattern, a pattern of the specified number of measures will playback repeatedly, allowing you to continue adding musical data to it.

- Create a new song, and as described in “Preparations for recording” on page 83, set the track to the program that will be used by the pattern.
- Access the P5: Pattern/RPPR–Pattern Edit page (See the diagram below).
- Use “Track Select” to select the track that you will use to record the pattern.

The pattern will sound with the program and other settings of the selected track.

- Set “Pattern (Pattern Bank)” to User, and set “Pattern Select” to U00.

User patterns U00–U99 can be created for each song.

- Select the page menu command “Pattern Parameter”.

A dialog box will appear.

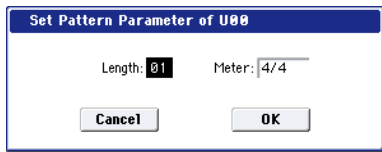

6. Set the number of measures in the pattern to a "Length" of 04 (four measures), and set "Meter" to a time signature of 4/4. Press the OK button.
7. As necessary, set "REC Resolution" to apply realtime quantization.
8. Begin realtime recording.

You can record in the same way as you did when recording tracks with Loop All Tracks. (See "Loop All Tracks" on page 87.)

Press the SEQUENCER REC/WRITE switch, and then press the SEQUENCER START/STOP switch.

After the pre-count, pattern recording will begin. Play the keyboard and operate the joystick and other controllers to record your performance.

When you reach the end of the pattern, the sequencer will return to the beginning of the pattern and continue recording. If you continue recording, the newly recorded data will be added to the previously-recorded data.

9. If you want to delete specific data while you continue pattern recording, you can press the SEQUENCER REC/WRITE switch or check the "Remove Data" check box.

For details refer to step 6 of "Loop All Tracks" on page 87.

10. Press the SEQUENCER START/STOP switch to stop recording.

If you made a mistake or decide to re-record, press the SEQUENCER START/STOP switch to stop recording, and press the COMPARE switch. Then begin the pattern recording procedure again as in step 8.

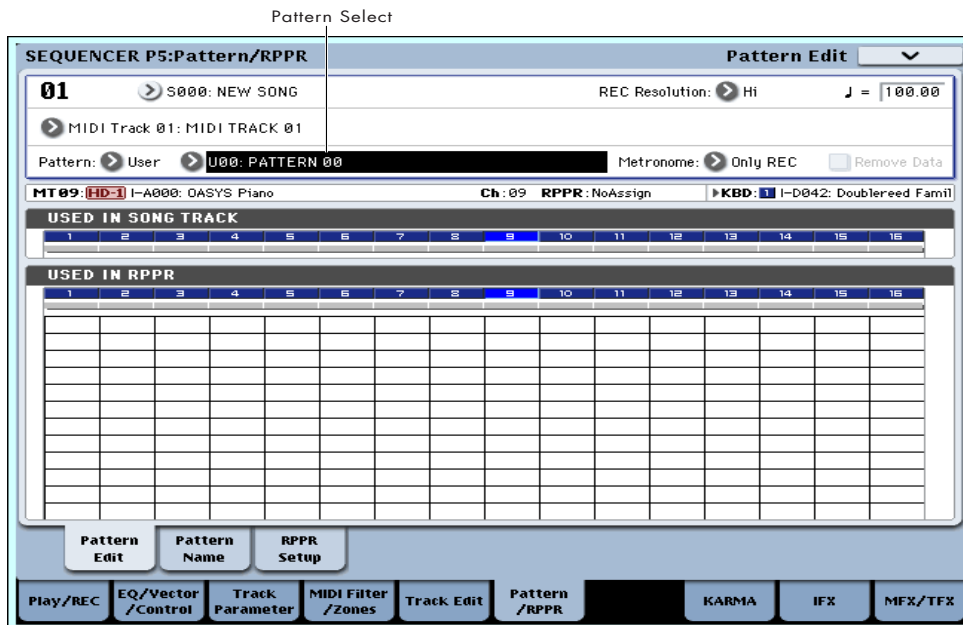

Control data in pattern recording

To record control data in a pattern, you should restore the control data to its normal value within the pattern. If you fail to restore the normal value, unnecessary control data may remain in a "stuck" position when you place the pattern in a song or use the RPPR function to play the pattern. However, the following control data will be automatically reset to the following values when the song or RPPR function finishes playing the pattern, or when playback is halted.

Controller	Reset value
Modulation 1 (CC#01)	00 (zero)
Modulation 2 (CC#02)	00 (zero)
Expression (CC#11)	127 (max)
Ribbon controller (CC#16)	64 (center)
Damper switch (CC#64)	00 (zero)

Controller	Reset value
Sostenuto switch (CC#66)	00 (zero)
Soft switch (CC#67)	00 (zero)
EG sustain level (CC#70)	64 (center)
Resonance level (CC#71)	64 (center)
EG release time (CC#72)	64 (center)
EG attack time (CC#73)	64 (center)
Low pass filter cutoff (CC#74)	64 (center)
EG decay time (CC#75)	64 (center)
LFO1 speed (CC#76)	64 (center)
LFO1 depth (pitch) (CC#77)	64 (center)
LFO1 delay (CC#78)	64 (center)
Filter EG intensity (CC#79)	64 (center)
SW1 modulation (CC#80)	00 (zero)
SW2 modulation (CC#81)	00 (zero)

Controller	Reset value
Channel after touch	00 (zero)
Pitch bender	00 (zero)

Using KARMA for pattern recording

If the KARMA function is set to operate for the track that is selected for “Track Select,” and record the performance of the KARMA function into the pattern.

Other ways to record

Multi-track recording with KARMA

You can record multi-track performances generated by KARMA. For more information, see “KARMA function settings in Sequencer mode” on page 210.

Multi-track recording with RPPR

You can record multi-track performances generated by RPPR. For more information, see “Using RPPR (Realtime Pattern Play/Record)” on page 112.

Using the control surface to record changes in the pan, EQ, volume, or Tone Adjust parameters of a MIDI track

During realtime recording, you can use the control surface to control the pan, EQ, volume, or Tone Adjust parameters, and record these changes so that they will be reproduced during playback.

If you will be adjusting more than one track simultaneously, you’ll need to use multi-track recording.

Note: Changes you make using the control surface are transmitted as control changes or system exclusive messages. In order to record these changes, the Global P1: MIDI–MIDI “Enable Control Change” and “Enable Exclusive” items must be checked. Move to Global mode and make sure that these items are checked.

Audio recording

Overview: About the OASYS' hard disk recorder

- There are sixteen audio tracks. They allow 16-bit linear PCM recording with a maximum time of 80 minutes.
- Automation data (volume, pan, EQ, send 1/2) can be recorded for each track.
- Up to sixteen tracks can be played back simultaneously, and up to four tracks can be recorded simultaneously.
- The Stereo Pair function lets you assign two tracks as a pair for recording, control, and editing.
- You can choose from a broad range of internal buses as the recording source; Audio Input 1–4, S/P DIF, L/R, REC Bus 1–4, or Indiv 1–8. You can also route the signal very flexibly, for example by inserting effects into external audio sources and recording the result.
- When you realtime-record, an audio event and region data are created and assigned to the track. The region data contains a link to the WAVE file (audio data) that's recorded on the hard disk. You can edit in a variety of ways, for example by changing the location of the audio event, or by editing/replacing the region data or WAVE file.
- Auto or manual punch-in/out are provided.
- The Rehearsal function lets you practice a punch-in/out without actually recording.
- You can use the control surface mixer to adjust the pan and volume etc. of the audio tracks, and record these operations as automation events so that the pan and volume changes will be reproduced during playback.

Audio events and regions in an audio track

When you record on an audio track, the actual audio data is recorded directly on the internal hard disk as a WAVE file. At this time, a "region" is also created; this contains information specifying what portion of that WAVE file is to be actually played back. In addition, an "audio event" which assigns that region is created; this specifies the location in the song at which the audio will play.

When playback reaches a point in the song where an audio event is located, the WAVE file on the hard disk will be played as specified by the audio event and the region. In other words, the audio will not play if either the audio event, the region, or the WAVE file are missing.

⚠ Please note that audio events and regions can be deleted by audio event editing or region editing, and can also be easily lost if you turn off the power before saving to the hard disk. If only the WAVE file is left on the hard disk, this will occupy hard disk capacity for no purpose; we recommend that you execute "Delete Unused WAV Files" (See PG p.523) to free up any such wasted space.

How audio data is stored on the disk

When you save Songs to disk, they're stored in an .SNG file. This .SNG file contains all of the data from Sequencer mode, including all of the Songs in memory, except for the related audio files.

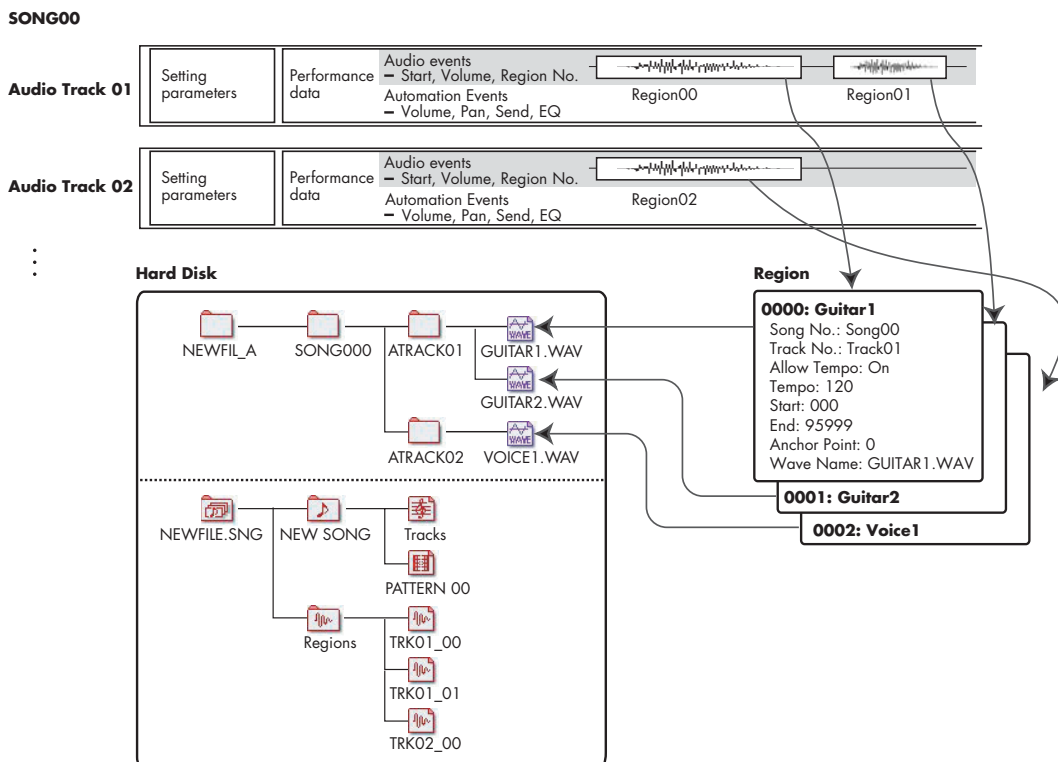

When you save an .SNG file, its related audio files are stored in a separate directory. This directory is created automatically, within the same directory as the .SNG file. (It's also created if you load a pre-existing .SNG file which doesn't have a matching audio directory.) The directory's name consists of the first six characters of the .SNG file's name, with the suffix "_A" (for "Audio").

For instance, if the .SNG file is named WAMOZART.SNG, its audio directory will be named WAMOZA_A.

This main directory contains sub-directories for each song, named SONG000, SONG001, etc. These in turn contain sub-directories for each audio track, named ATRACK01, ATRACK02, and so on. Within each of the track sub-directories, each individual audio take is stored as a WAVE file.

Temporary audio files

If you're recording a new song, and haven't yet saved it as an .SNG file, the audio files are stored in a temporary location on disk. The directory structure is the same as described above, except that the main audio directory is named TEMP.

Once you save the song(s) to an .SNG file, these directories and audio files will be copied to the new "_A" folder automatically. On the other hand, if for some reason you don't or can't save before turning off the power, you'll be given the chance to restore these audio files the next time that you start up the instrument. Note that while the audio files can be recovered this way, the rest of the sequencer data cannot be restored.

Move or re-name audio and .SNG files together

If you move or re-name an existing .SNG file, make sure to move or re-name its corresponding audio directory as well. The main audio directory must be in the same folder as the .SNG file, and must be named as described above.

Audio input settings and recording source selection

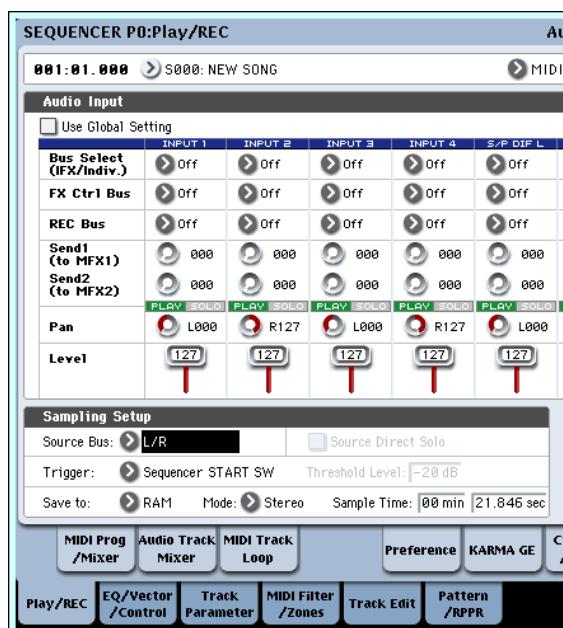

Use Global Setting

You can configure the audio inputs separately for each Song, if desired. Alternatively, you can use the Global setting, as made on the Global P0: Basic Setup– Audio page.

If **Use Global Setting** is enabled, the Song will use these Global settings, and all of the other settings under Audio Input will be grayed out.

Input 1...4, S/P DIF L, S/P DIF R

Input 1...4: These are the input settings for analog audio sources connected to the INPUT 1–4 jacks.

The INPUT 1 and 2 jacks provide XLR and 1/4" TRS balanced connectors. You can input mic level or line level signals.

Set the MIC/LINE switch to the setting appropriate for the connected device, and use the LEVEL knob to adjust the level. For more information, see "Setting levels" on page 101.

Use the LINE position (switch pressed inward) if you've connected a mixer, computer, audio system, signal processor, or another synthesizer.

Use the MIC position (switch outward) if you've connected a mic. If you are using a condenser mic that requires phantom power, turn the PHANTOM POWER switch ON. Otherwise, leave this switch OFF.

⚠ Never connect an unbalanced instrument, device, or mic to the XLR jack if phantom power is turned on.

Only line-level signals from instruments or other equipment can be input to INPUT jacks 3 and 4. These are unbalanced 1/4" phone jacks.

Note: Guitars with active pickups can be connected directly to any of the inputs. Guitars with passive pickups (i.e., guitars that do not have an internal preamp) can be used with inputs 1 and 2, but the impedance mismatch will cause both a change in tone and a reduction in volume. For best results, route such guitars through a pre-amp or effects unit before connecting them.

S/P DIF L, S/P DIF R: These are the input settings for digital audio sources such as instruments, DATs, digital mixers, etc. connected to the S/P DIF IN jack. The S/P DIF input and output jacks support 48 kHz and 96 kHz sample rates. Use "S/P DIF Sample Rate" (Global P0: Global Setup– Basic Setup page) to make this setting. 96 kHz data is converted to 48 kHz for recording.

When sampling via S/P DIF, you must set the Global mode **System Clock** appropriately. For more information, please see "System Clock" on page 644 of the Parameter Guide.

Bus Select (IFX/Indiv.)

This specifies the output bus for each audio signal.

Off: The external audio input signal will not be sent to any bus. However, you can still record the external audio signal directly by using the P0: Play/REC–Audio Track Mixer page **REC Source** setting to choose an external input (Audio Input 1–4, S/P DIF L, S/P DIF R) for recording.

L/R: The external audio input signal will be sent to the L/R bus. Choose this when you want other signals such as the OASYS' internal tone generator to be recorded along with an external audio source. Set **REC Source** to L/R.

IFX1...12: The external audio input signal will be sent to the IFX1–12 bus. Choose this when you want to apply an insert effect while recording. Set **REC Source** to match the post-IFX **Bus Select** setting.

1...8: The external audio input signal will be sent in monaural to INDIVIDUAL 1, 2, 3, 4, 5, 6, 7, or 8.

1/2...7/8: The external audio input signal will be sent via **Pan** in stereo to INDIVIDUAL 1 and 2, 3 and 4, 5 and 6, or 7 and 8. Set **REC Source** to the corresponding INDIV. setting.

Be aware that if you change **Bus Select (IFX/Indiv.)** from Off to L/R or IFX, the volume level from AUDIO OUT L/MONO and R jacks or from the headphone jack may increase abruptly. Please use caution.

FX Ctrl Bus (FX Control Bus)

This sends the external audio input signal to the FX Control bus (stereo two-channel (FX Ctrl1, 2)). For more information, see "FX Control Buses" on page 730 of the Parameter Guide.

REC Bus

This sends the external audio input signal to the REC buses (four mono channels: 1, 2, 3, 4).

The REC buses are dedicated internal recording buses that you can use for recording or sampling audio tracks.

Recording becomes possible if you choose a REC bus as the "Source Bus." For example, you can use the REC buses if you want to record only an audio input source that is being played along with the song being output from the L/R bus (i.e., record the input source, but not the song playback). You can also mix several audio inputs to the REC buses, or mix the direct signal from audio inputs to REC buses along with post-IFX sound and record the result.

Off: The signal will not be output to the REC buses. Normally you will leave this Off.

1, 2, 3, 4: The external audio input signal will be sent to the specified REC bus. The **Pan** setting is ignored, and the signal is sent in monaural.

1/2, 3/4: The external audio signal will be output to the REC buses in stereo. According to the **Pan** setting, it will be sent in stereo to buses 1 and 2, or 3 and 4.

Send1 (to MFX1), Send2 (to MFX2)

These specify the level at which the external audio input signal will be sent to the master effects.

Send1 (to MFX1) sends the signal to master effect 1.

Send2 (to MFX2) sends the signal to master effect 2.

If **Bus Select (IFX/Indiv.)** is set to IFX1–12, the send levels to the master effects are specified by the **Send1** and **Send2** settings that follow IFX1–12.

PLAY/MUTE

These indicate whether each external audio input signal is in Play or Mute condition.

Use the MIX PLAY/MUTE 1–6 switches to change the status.

SOLO On/Off

This indicates the SOLO status of each external audio input signal. Use the MIX SELECT 1–6 switches to change the solo status.

Sound will be output only from channels whose SOLO is On. Other channels will be muted. Solo operation includes both MIDI tracks and audio tracks.

Pan

This specifies the panning of each external audio input signal. If you are inputting a stereo audio source, you will normally pan the inputs to L000 and R127 respectively.

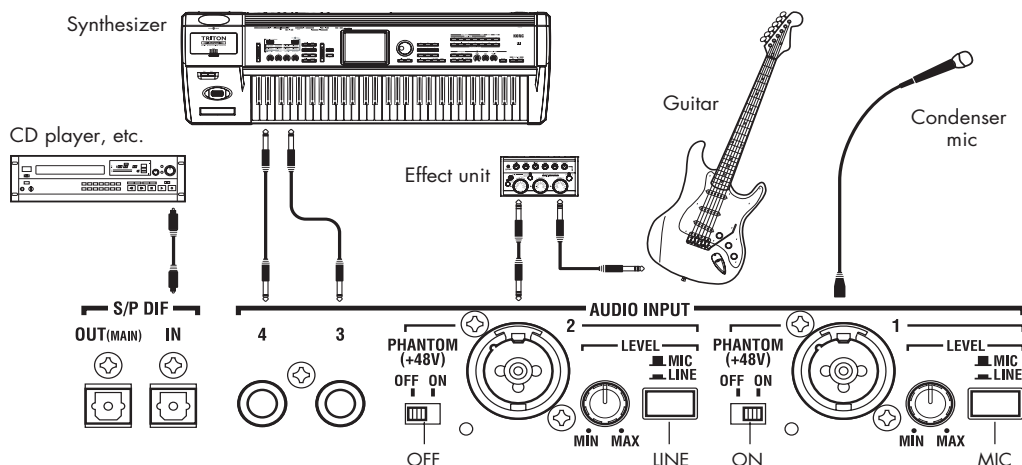

Level

This controls the level of the external audio signal. The default is 127.

The analog audio signals from AUDIO INPUTS 1–4 are converted into digital form by an A/D converter. This parameter sets the level of the signal immediately after this conversion.

If the sound is distorted even though this level setting is very low, see “Tips for eliminating distortion when using the analog inputs” on page 102.

Avoiding extraneous noise

⚡ If audio cables are connected to AUDIO INPUTS 1–4, any noise carried by the cables will enter into the OASYS mixer structure. Similarly, the S/P DIF input may carry noise from external devices. This may include hiss, hum, and other audio noise.

To avoid noise from unused audio inputs, either:

- Set the input’s **Level** to 0
- or
- Set all of the bus assignments to **Off**, including **Bus Select (IFX/Indiv. Out Assign)**, **REC Bus**, and **FX Control Bus**

If no audio cables are connected to AUDIO INPUTS 1–4, the input signals are forced to zero, preventing any additional noise.

Audio Track Mixer

You can specify the audio source to record from, and change the Play/Mute status, SOLO status, pan, and volume for playback.

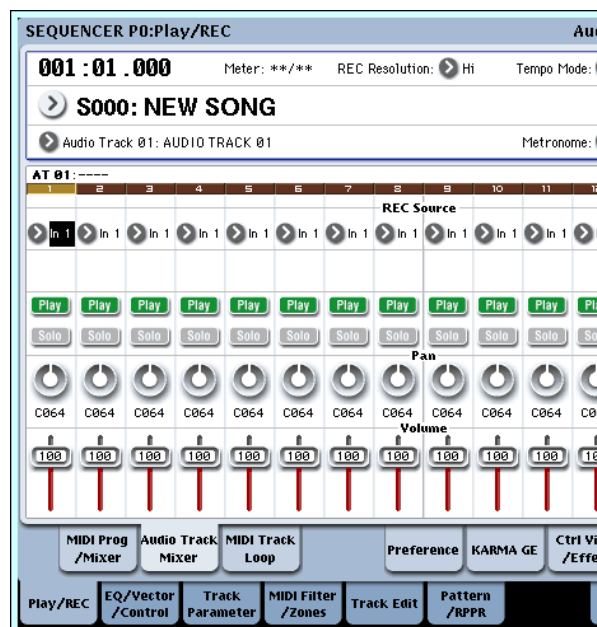

REC Source

This selects the source that will be recorded on the track. The signal of the bus line you specify here will be recorded. See below for a diagram of buses when recording from the audio inputs; for more detailed diagrams, see under “0–2: Audio Track Mixer” on page 421 of the Parameter Guide.

If you set the “Track Select” field to Audio Track, you will be able to monitor the **REC Source** of that track.

The mode of operation will differ depending on whether adjacent audio tracks are paired (“Stereo Pair”) or not.

Audio Input 1...4, Audio Input 1/2, Audio Input 3/4, S/P DIF L, R, S/P DIF L/R: Choose these if you want to directly record the audio input from the AUDIO INPUT 1–4 or S/P DIF jacks. The input from the AUDIO INPUT 1–4 or S/P DIF jacks will be recorded directly without passing through the L/R bus, REC buses, or Individual buses. AUDIO INPUT 1, 2, 3, 4, 1/2, 3/4, or S/P DIF L, R inputs will be connected directly, regardless of the Audio Input settings for “Bus (IFX/Indiv),” **Pan**, and “Level.” “Level,” “Solo,” and “Play/Mute.” See “REC Source = Audio Input 1, 2, 1/2” diagram.

If “Stereo Pair” is on and Audio Input 1/2 is selected, AUDIO INPUT 1 will be input to the odd-numbered track, and AUDIO INPUT 2 will be input to the even-numbered track. Similarly, Audio Input 3/4 and S/P DIF L/R will be input to the odd-numbered and even-numbered tracks respectively.

L, R, L/R: The L/R bus after passing through TFX 1 and 2 will be recorded. Choose this if you want to record an external audio signal being sent to the L/R bus, or the sound being produced by the OASYS (and sent to the L/R bus) in response to sequencer playback, keyboard playing, or MIDI input.

If “Stereo Pair” is on, L is sent to odd-numbered tracks, and R is sent to even-numbered tracks.

REC 1, 2, 1/2, REC 3, 4, 3/4: The REC 1/2 or REC 3/4 buses will be recorded. Choose this if you want to record only the audio input while hearing the sequencer playback and your keyboard playing from the L/R outputs. You can also mix several audio inputs to the REC buses, or use the REC buses to mix the direct sound from the audio inputs with the sound processed by insert effects, and record the result.

If “Stereo Pair” is on, REC bus 1 (3) is sent to odd-numbered tracks, and REC bus 2 (4) is sent to even-numbered tracks.

Indiv.1...8, Indiv.1/2, Indiv.3/4, Indiv.5/6, Indiv.7/8: The Indiv.1/2–Indiv.7/8 buses will be recorded.

Similarly to when using the REC buses, you can choose this when you want to monitor the L/R output while recording only the audio input.

If “Stereo Pair” is on and you’ve selected Indiv.1/2, the Indiv. bus 1 will be sent to odd-numbered tracks, and Indiv. bus 2 will be sent to even-numbered tracks.

Play/Rec/Mute

Use this to mute an audio track, or to select the recording tracks for multi-track recording. During playback, or for single-track recording (normal recording), it is possible only to select Play or Mute for tracks (playback tracks) other than the recording track. For multi-track recording, tracks can be set to Play, Mute, or Rec. The setting will alternate each time you press the Play/Rec/Mute button.

Solo On/Off

This turns the Solo function on/off.

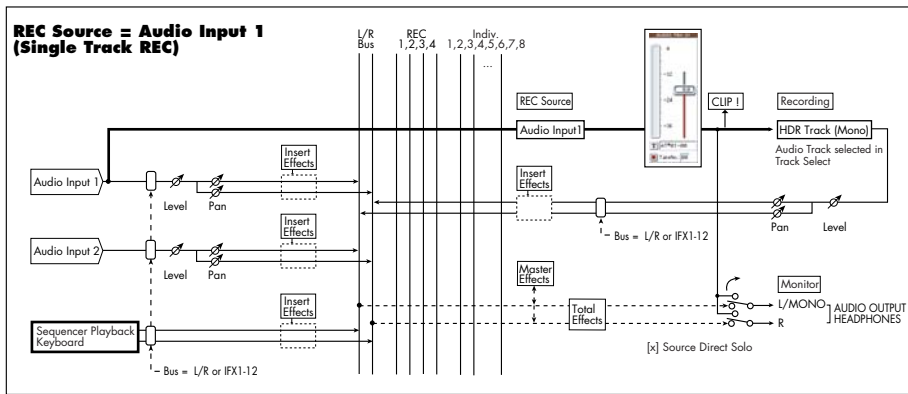

Pan

This specifies the pan of audio track.

Volume

Sets the volume of audio tracks 1–16.

Recording procedure

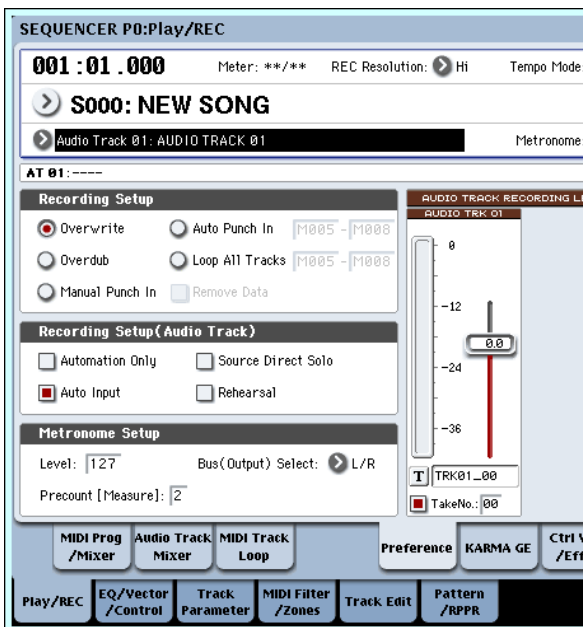

Recording Setup

These parameters specify how audio tracks will be recorded.

For details on each recording method, refer to the examples for MIDI tracks. (See “Recording setup” on page 85)

However, this differs from MIDI track recording as follows.

Overwrite

When recording for the first time, you will normally select this method.

To begin recording, press the SEQUENCER REC/WRITE switch and then the SEQUENCER START/STOP switch. To stop recording, press the SEQUENCER START/STOP switch once again.

Audio Track Audio Events: Only the measures you recorded will be overwritten; the data in subsequent measures will remain unchanged.

Audio Track Automation Events: All data following the measure at which you begin recording will be erased.

Overdub

Select this method when you wish to add Audio Track Automation Event data to a previously-recorded track.

To begin recording, press the SEQUENCER REC/WRITE switch and then the SEQUENCER START/STOP switch. To stop recording, press the SEQUENCER START/STOP switch once again.

Audio Track Audio Events: As with Overwrite, only the measures you recorded will be overwritten; the data in subsequent measures will remain unchanged.

Audio Track Automation Events: The previously-recorded data will remain, and the newly-recorded data will be added to it.

Manual Punch In

Select this method when you wish to use the SEQUENCER REC/WRITE switch or a foot switch to re-record selected portions of a previously-recorded track.

Auto Punch In

Select this method when you wish to automatically re-record selected portions of a previously-recorded track.

For both Manual Punch In and Auto Punch In, recording will occur as follows.

Audio Track Audio Events, Audio Track Automation Events: Only the measures you recorded will be overwritten; the data in subsequent measures will remain unchanged.

Loop All Tracks

Choose this method if you want to repeatedly record track automation events over a specified region of measures, adding data at each pass. Only automation events can be recorded. You can use “Remove Data” to remove audio track automation events.

Audio events cannot be recorded. This means that if you set “Track Select” to Audio Track, and turn “Automation Only” Off, you will be unable to start recording.

Recording Setup (Audio Track)

Automation Only

Normally you will record with this unchecked. Both audio track automation events and audio events will be recorded.

If this is checked, only audio track automation events will be recorded. Use this setting if you want to record automation after recording.

Auto Input

This parameter controls monitoring during recording. It automatically switches all record-enabled tracks between monitoring the record input and the track playback, according to whether or not recording is active.

This lets you listen to audio you’ve already recorded when punching in, and also means that you don’t have to disable track record-enables in order to listen to playback.

This applies only to record-enabled tracks. If Multi REC is off, this is the REC Track (as selected in the **Track Select** menu). If **Multi REC** is on, this means to all tracks whose **Play/Rec/Mute** button is set to Rec.

Normally, Auto Input should be enabled (checked). When enabled, record enabled tracks will be monitored as follows:

- When stopped, the monitor carries the input signal.
- When playing but not recording, the monitor carries the track playback.
- When recording, the monitor carries the input signal.

For audio tracks which are not record-enabled, you’ll always be monitoring the track playback.

Audio track monitoring (Input: REC Source, Track: track playback)

	Auto Input	During Stop	During Play	During Rec	During Punch Rec		
					...In	In...Out	Out...*
Record Tracks	On	Input	Track	Input	Track	Input	Track*
	Off	Input					
Other Tracks	On	Track Playback					
	Off						

Source Direct Solo

If this is unchecked, the L/R (post-TFX) and bus line signal(s) specified by **REC Source** will be sent from the L/R jacks and the headphone jack as specified by the Audio Input **Bus Select (IFX/Indiv.)** and post-IFX **Bus Sel.** settings. This is the normal state.

Normally you will leave this unchecked, and Check this if you want to monitor only the sound that’s being recorded. Only the signal of the bus line specified by **REC Source** will be output to the L/R jacks and the headphone jack. When using Multi REC, you’ll hear the sound from the **REC Source** buses whose **Play/Rec/Mute** setting is set to REC.

Note: If the **REC Source** is L/R, this setting is ignored; the L/R (post-TFX) signal is output from the L/R jacks and the headphone jack.

Rehearsal

Check this if you want to rehearse before actually recording on an audio track. (recording will not actually occur).

Audio Track Recording Level

This indicates the input level to the audio track selected for **Track Select** (when using single-track recording), or the input level to the audio tracks whose **Play/Rec/Mute** setting is REC (when using multi-track recording: maximum 4 tracks).

Recording Level 1, 2, 3, 4 Level Meter 1, 2, 3, 4

This adjusts the final-stage signal level of each **REC Source** being recorded to the audio tracks.

The upper part of the level meter/slider shows the corresponding audio track number.

If you’re single track recording, **Recording Level 1** and **Level Meter 1** both apply.

If you’re using multi-track recording, the settings for tracks whose **Play/Rec/Mute** is REC will be valid.

When using single-track recording, the level meter will show the recording level if you set “Track Select” to Audio Track. When using multi-track recording, press the SEQUENCER REC/WRITE switch to enter record-standby mode, and the level meter will show the recording level.

Note: The settings up to this point are the same as if you executed the page menu command **Auto HDR/Sampling Setup** with the HDR (Audio Track Recording) setting, to make the setup automatically. **Audio Input, REC Source, Track Select,** and **Overwrite** are set automatically. For more information, see “Auto HDR/Sampling Setup: Automatically-set parameters and their values” on page 533 of the Parameter Guide.

Setting levels

For the best results, set the levels as described below:

1. If **Multi REC** is off, set **Track Select** to an **Audio Track**.
or
If **Multi REC** is On, record-enable the desired **Tracks**, and then press the SEQUENCER REC/WRITE switch.

The **Level Meter(s)** will now show the recording level(s).

2. Initially, set the **Recording Level(s)** to 0.0dB.

- Adjust the level(s) of the input signal(s) so that it is as high as possible without activating the CLIP! or ADC OVERLOAD! messages.

If you're using AUDIO INPUTS 1 and/or 2, adjust the volume using rear-panel MIC/LINE switches and LEVEL knobs.

If you're using AUDIO INPUT 3 and/or 4, or the S/P DIF input, adjust the output level of your external audio source.

If you're sampling external audio through the internal effects, you may also need to adjust the individual effects input and/or output level parameters.

If you're using internal sounds, adjust the levels using the control surface, effects input/output trim, etc.

- If the level is still not high enough, increase the Recording Level using the on-screen slider.

Again, the goal is to get the level as high as possible without activating the CLIP! or ADC OVERLOAD! messages.

Tips for eliminating distortion when using the analog inputs

If sound from the analog inputs is distorted, but the CLIP! message doesn't appear, it's possible that distortion is occurring at the analog input stage, or that distortion is being caused by the settings of the internal effects.

If the "ADC OVERLOAD!" message appears above the Recording Level meters, the distortion is due to excessive levels at the input. In this case, either lower the output level of the external audio source, or (for inputs 1 and 2 only) adjust the MIC/LINE gain select switch and LEVEL knob so that this message does not appear.

If there is distortion, but the "ADC OVERLOAD!" message does not appear, it's possible that the distortion is being caused by the settings of the internal effects. To solve this problem, either lower the input Level, or adjust the effects settings (such as changing the individual effect Input Trim parameters).

Examples of audio track recording

Recording an external input source on audio track 1

In this example, we'll explain how a guitar connected to the Audio Input 1 jack can be recorded on audio track 1.

- Recording and playback on an audio track can occur until the end of the master track. You cannot record for longer than 80 minutes.

Connect your guitar

- Connect your guitar to the rear panel AUDIO INPUT 1 jack.

Press the AUDIO INPUT MIC/LINE switch inward to select the LINE position, and set the LEVEL knob at about the center.

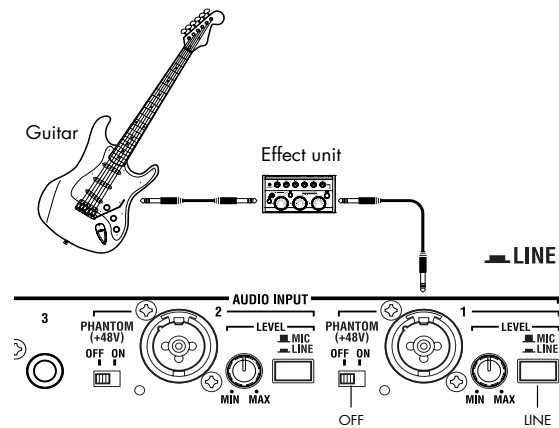

- If you connect a guitar with passive pickups (i.e., a guitar that does not contain a preamp), you will be unable to sample it at the correct level because of the impedance mismatch. Such guitars should be routed through a preamp or an effect unit.

Setup

- In the P0: Play/REC– Audio Input Sampling page, set the "Audio Input" parameters as follows.

Use Global setting Off

– INPUT 1 –

Bus Select (IFX/Indiv.): Off

Pan: L000

Level: 127

REC Bus: Off

(These settings are made by default, so you don't need to make them.)

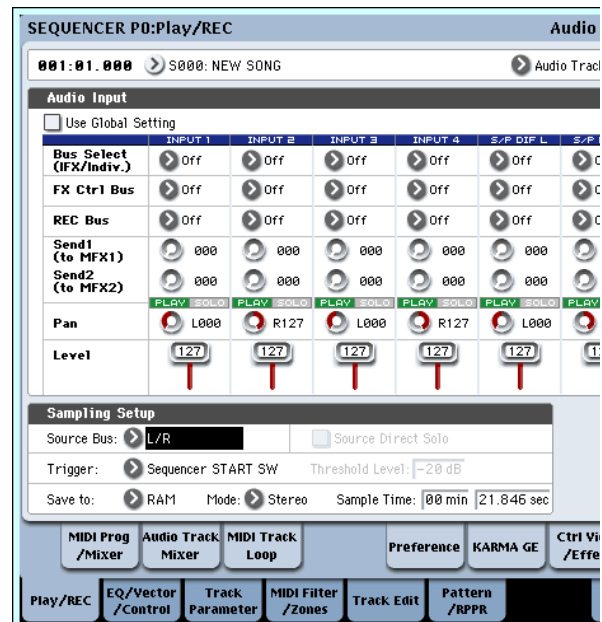

In the P0: Play/REC– Audio Track Mixer page, use REC Source to select Audio Input 1 (AIn 1), so that the signal from Audio Input 1 will be recorded directly on audio track 1.

Audio Track 1 REC Source: Audio Input 1 (AIn 1)

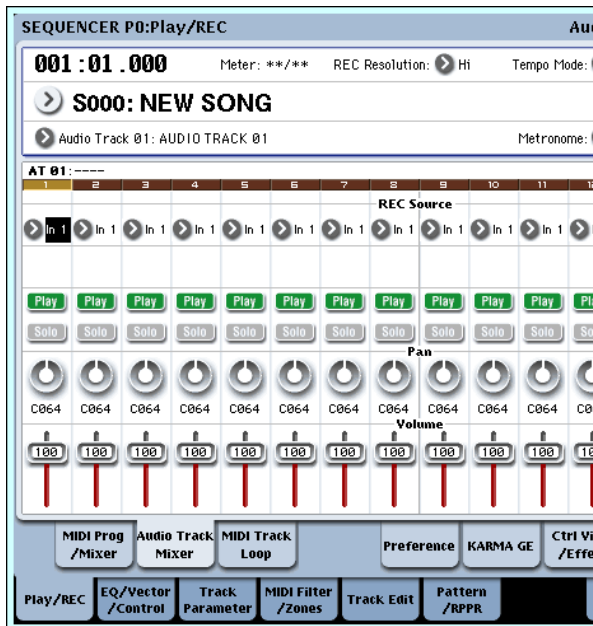

Access the P8: Insert Effect– Audio Routing1 page. In “Audio Track 1,” specify the output for audio track 1.

Bus Select (IFX/Indiv. Out Assign) Bus Select (IFX/Indiv. Out Assign): L/R

“Send1 (MFX1),” “Send2 (MFX2)”: 000

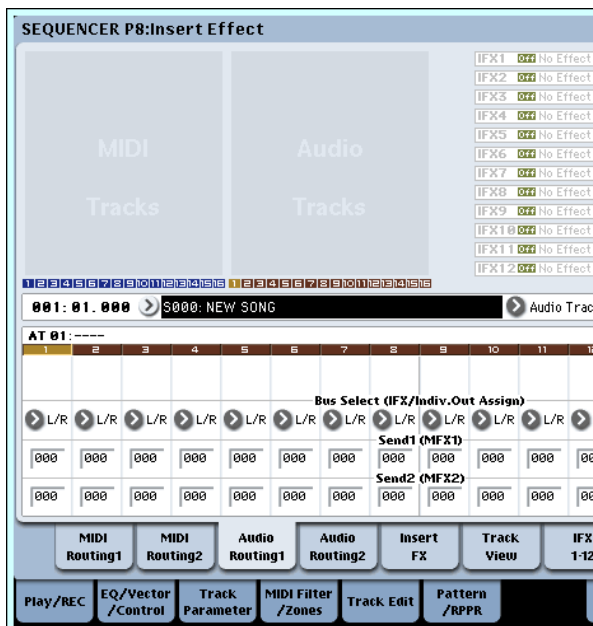

3. In the P0: Play/REC– Preference page, set “Track Select” to Audio Track 01.

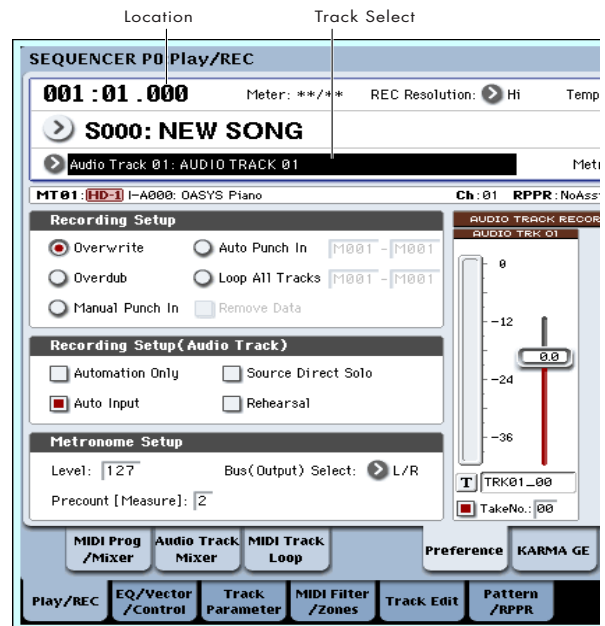

AUDIO TRK 01 (“Level Meter 1,” “Recording Level 1,” “Name 1,” **Take**, **Take No.**) will appear.

Use the “Name 1” field to specify a name for the region and WAVE file that will be created.

If you intend to record several takes on the same track, check the **Take** option box.

4. Specify the recording method in Recording Setup and “Recording Setup (Audio Track).”

“Overwrite”: selected

“Automation Only”: unchecked

“Source Direct Solo”: unchecked

“Auto Input”: checked

“Rehearsal”: unchecked

Note: If you want to record from the beginning of the song or from the measure specified by “Location,” you should select “Overwrite.”

Note: If **Take** is unchecked, you will be able to input up to eight characters as the file name. If it is checked, you will be able to input up to six characters.

Note: If you want the metronome to sound during recording, use **Metronome Setup** to make metronome settings. For more information, see “0–5d: Metronome Setup” on page 431 of the Parameter Guide.

Set the recording level

5. Play your guitar at the volume you intend to record.

If the “ADC OVERLOAD !” (AD converter input overload) indication appears, turn the rear panel LEVEL knob toward MIN to adjust the level appropriately.

For the best sound, adjust the level as high as possible without allowing the “ADC OVERLOAD !” indication to appear.

6. The level meter will show the volume of the guitar signal that will be recorded.

If the “CLIP !” indication appears, use the VALUE controller etc. to lower the **Recording Level** slider

(located in the right side of the display) from +0.0 down to an appropriate level.

Press the SEQUENCER START/STOP switch to play back the song, and check the volume balance. If you want to monitor only the guitar sound during playback, check “Source Direct Solo.”

Record

7. In the P0: Play/REC– Preference page, use “Location” to specify the location at which recording will begin.

If you want to start recording from the beginning of the song, set this to 001:01.000.

8. Press the SEQUENCER REC/WRITE switch

The OASYS will be in record-ready mode. If you’ve made metronome settings, the metronome will sound the count.

9. Press the SEQUENCER START/STOP switch.

Recording will start from the location you specified in “Location.”

If you have specified a metronome pre-count (“Precount [Measure]”), recording will begin after the pre-count. If a performance has already been recorded on a MIDI track, that MIDI track will also play back.

10. To stop recording, press the SEQUENCER START/STOP switch.

Listen to the recorded result

11. Access the P0: Play/REC– Audio Track Mixer page.

In “Audio Track 1,” set the pan and volume etc. for audio track 1.

Play/Rec/Mute: Play

Solo On/Off: Off

Pan: C064

Volume: 100

12. Press the SEQUENCER START/STOP switch to play back the song.

Note: You can use functions such as Compare when recording audio events, just as you can when recording MIDI tracks.

Note: If you want to apply an insert effect on an audio track, set **Bus Select (IFX/Indiv. Out Assign)** to IFX1–IFX12.

Then select L/R as the **Bus Select** setting (P8: Insert Effect– Insert FX page) that follows the insert effect you used.

Note: If you want to apply master effects to an audio track, use **Send1 (MFX1)** and **Send2 (MFX2)** to set the send levels to the master effect. If you’re using an insert effect, adjust the **Send1** and **Send2** settings that follow that insert effect.

Recording an external input source on audio track 2 while you listen to the previously-recorded audio track 1

In this example, we’ll record another guitar performance on audio track 2 while monitoring the performance you previously recorded on audio track 1 as described in “Recording an external input source on audio track 1.”

1. In the P0: Play/REC– Audio Track Mixer page, set the Audio Input 2 REC Source to Audio Input 1 (AIn 1).

AUDIO TRACK 2 REC Source: Audio Input 1 (AIn 1)

2. Set Track Select to Audio Track 02.
3. Record as described in step 8 and following of the preceding section.

Applying an insert effect while you record

In this example, we’ll apply an insert effect to the guitar that’s connected to Audio Input 1, and record the effect-processed sound on audio track 1.

Connect your guitar

1. Connect your guitar. (See p.61 “Recording an external input source on audio track 1”)

Setup

2. In the P0: Play/REC– Audio Input/Sampling page, set the “Audio Input” parameters as shown below that the signal from the AUDIO INPUT 1 jack is sent to IFX1.

Use Global Setting: Off

Bus Select (IFX/Indiv.): IFX1

INPUT1 Level: 127

INPUT1 Pan: L000

INPUT1 REC Bus: Off

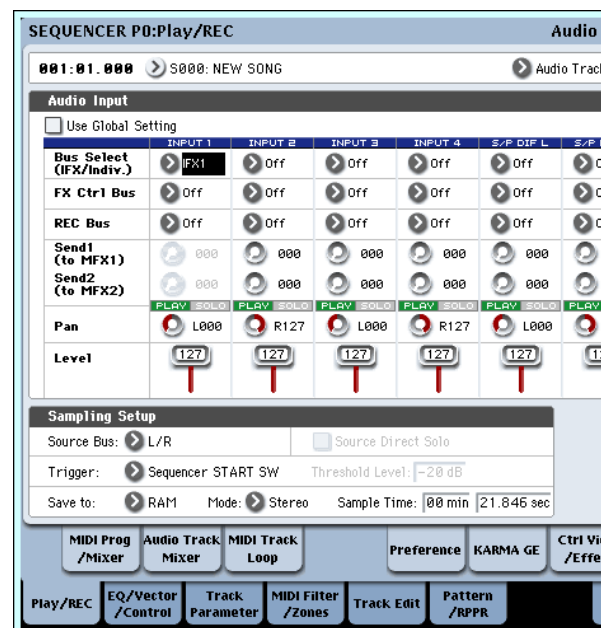

3. In the P8: Insert Effect– Insert FX page, select the desired effect and route it to REC bus 1.

IFX1 On/Off: On

IFX1: the desired effect

Bus Sel.: Off

REC Bus: 1

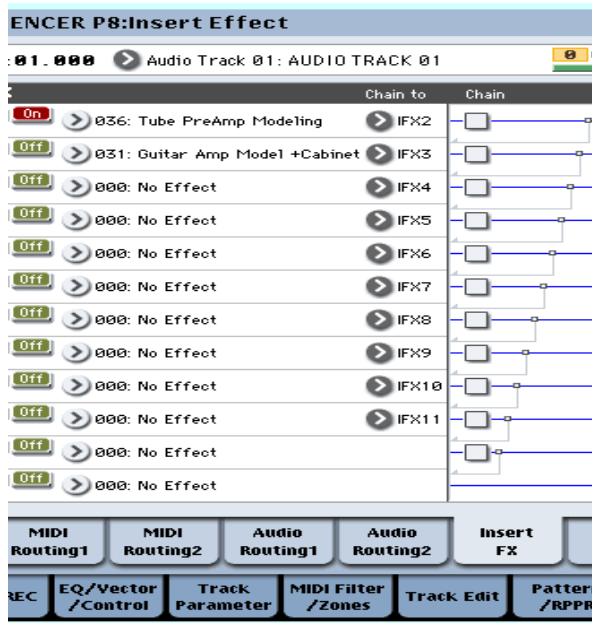

- In the P0: Play/REC– Audio Track Mixer page, set REC Source to REC1 so that the signal of the REC bus will be recorded on audio track 1.

Audio Track 1 REC Source: REC1

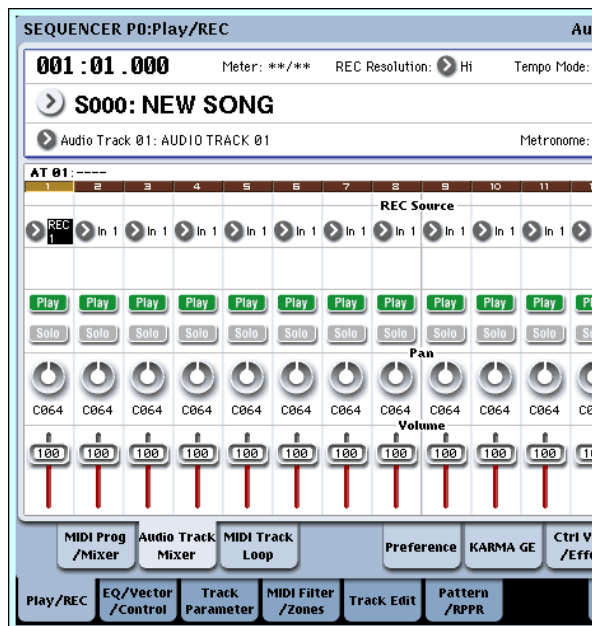

- In the P0: Play/REC Preference page, set “Track Select” to Audio Track 01.

The remaining steps are the same as step 3 and following of the preceding section “Recording an external audio source on audio track 1.” Please refer to that section for details.

Punch-in recording an external input source on an audio track

In this example, we’ll show how to punch-in record a portion of the track you recorded in “Recording an external input source on audio track 1.”

Don’t change the P0: Play/REC– Audio Input/ Sampling page “Audio Input” settings, the P0: Play/ REC– Preference page “Recording Setup (Audio

Track)” settings, or the “P0: Play/REC– Audio Track Mixer page REC Source settings. We will use these settings as they are.

Setup

- In the P0: Play/REC– Preference page, make sure that Audio Track 01 is selected for the “Track Select” parameter.
- Use Recording Setup to specify how recording will start.

In this example, choose punch-in recording.

“Auto Punch In”: on

“M***-M***”: Specify the range of measures for which you want to record.

AUDIO TRK 01 Name, Take, Take No.: Specify the region and wave file name that you want to record.

Note: If you set Recording Setup to Auto Punch In and set “M***-M***” to the desired range of measures, playback will occur until that range of measures, and then only the specified range of measures will be recorded.

If you set Recording Setup to Manual Punch In, the measures you specify by pressing the SEQUENCER REC /WRITE switch or foot switch will be recorded. In this case, press the SEQUENCER START/STOP switch to play back the song. When you reach the measure at which you want to start recording, press the SEQUENCER REC /WRITE switch or the foot switch to begin recording. When you reach the measure at which you want to stop recording, press the REC /WRITE switch or foot switch once again; recording will end.

Rehearse

If desired, you can simulate the action of recording without actually recording. This will function just as if you were recording, but no audio event, region, or WAVE file will be created.

- In “Recording Setup (Audio Track),” check the “Rehearsal” option.
- Use “Location” to specify the location at which you want to start recording. Set this several measures earlier than the region you specified for “M***-M***”.
- Press the SEQUENCER REC/WRITE switch.

You will enter record-ready mode.

Once you press the SEQUENCER REC /WRITE switch, you will be unable to change the audio track selection in “Track Select.”

- Press the SEQUENCER START/STOP switch. Playback will begin from the measure specified by “Location,” and simulated recording will occur only in the range of measures specified by “M***-M***”. Then playback will resume, and will continue to the end of the song.

Note: If the “Recording Setup (Audio Track)” parameter “Auto Input” is Off, you will always be able to hear the REC Source. For more information, see “Auto Input” on page 429 of the Parameter Guide.

- Press the SEQUENCER START/STOP switch to stop recording.

- In "Recording Setup (Audio Track)," uncheck the "Rehearsal" option.

Record

- Use "Location" to specify the location at which you want to start recording. Set this several measures earlier than the region you specified for "M***-M***".

- Press the SEQUENCER REC/WRITE switch.

You will enter record-ready mode.

Once you press the SEQUENCER REC/WRITE switch, you will be unable to change the audio track selection in "Track Select."

- Press the SEQUENCER START/STOP switch.

Playback will begin from the measure specified by "Location," and recording will occur only in the range of measures specified by "M***-M***". Then playback will resume, and will continue to the end of the song.

Note: If the "Recording Setup (Audio Track)" parameter "Auto Input" is Off, you will always be able to hear the REC Source.

- Press the SEQUENCER START/STOP switch to stop recording.

Listen to the recorded result

- Press the SEQUENCER START/STOP switch to play back the song.

Make output settings for the audio track as described under "Listen to the recorded result" on page 104.

- Press the SEQUENCER START/STOP switch to stop playback.

Compare the recorded result

- Press the COMPARE switch (the COMPARE switch LED will light), and play back.

The audio track prior to punch-in recording will play back.

- Once again press the COMPARE switch (the COMPARE LED will go dark), and play back.

The audio track following punch-in recording will play back.

Other variations of audio track recording

Bouncing audio tracks

Bouncing lets you combine two or more tracks into either a single mono track, or a stereo pair.

In this example, we'll show how audio tracks 1 and 2 can be bounced to audio track 3.

Before you proceed, you'll need to record onto audio tracks 1 and 2. To record on audio track 2, make settings as described under "Recording Setup" on page 100, but in the P0: Play/REC– Audio Track Mixer page, set Audio Track 2 **REC Source** to REC1, and in the P0: Play/REC– Preference page, set "Track Select" to Audio Track 02.

Setup

- In the P0: Play/REC– Audio Track Mixer page, set

up audio tracks 1 and 2 as shown below:

– Audio Track 1 –
Play/Rec/Mute: Play

Solo On/Off: On

Pan: L000

Volume: 127

– Audio Track 2 –

Play/Rec/Mute: Play

Solo On/Off: On

Pan: L000

Volume: 127

Note: By setting **Solo On/Off** to On for both AUDIO 1 and AUDIO 2, you are specifying that only these audio tracks will be recorded.

- In the P8: Insert Effect– Audio Routing 1 page, specify the output for audio tracks 1 and 2.

– Audio Track 1 –

Bus Select (IFX/Indiv. Out Assign): L/R

"Send 1 (MFX1)," "Send 2 (MFX2)": 000

– Audio Track 2 –

Bus Select (IFX/Indiv. Out Assign): L/R

"Send 1 (MFX1)," "Send 2 (MFX2)": 000

Note: If you want to apply insert effects to the audio tracks, set **Bus Select (IFX/Indiv. Out Assign)** to your choice of IFX1–IFX12. Then choose L/R for the **Bus Select** setting (P8: Insert Effect– Insert FX page) that follows the insert effect you're using.

Note: If you want to apply master effects to an audio track, use "Send 1 (MFX1)" and "Send 2 (MFX2)" to adjust the send levels to the master effects. If you are using an insert effect on the audio track, adjust the **Send1** and **Send2** that follow the insert effect you're using.

- Press the SEQUENCER START/STOP switch to play back the song, and adjust the balance of the audio track 1 and 2 output levels.

The output level of each audio track is adjusted in the P0: Play/REC Audio Track Mixer page by the audio track 1 and audio track 2 **Volume** setting.

When you've finished making adjustments, stop playback.

- In the P0: Play/REC– Preference page, use "Track Select" to select Audio Track 03.

- In Recording Setup, Recording Setup (Audio Track), specify the desired recording method.

– Recording Setup –

Overwrite: on

– Recording Setup (Audio Track) –

Automation Only: unchecked

Source Direct Solo: unchecked

Auto Input: checked

Rehearsal: unchecked

– Audio TRK 03 –

Name, Take, Take No.: Specify the desired region and WAVE filename to be recorded.

- In the P0: Play/REC– Audio Track Mixer page, set REC Source so that L will be recorded on audio track 3.

Audio track 3 REC Source: L

Note: The settings up to this point are the same as if you used the page menu command **Auto HDR/Sampling Setup** to execute Bounce Audio Track with the following settings. For more information, see “If you selected Bounce Audio Track:” on page 530 of the Parameter Guide.

Mode: Mono

From: Audio Track 01: checked

Audio Track 02: checked

To: Audio Track 03

- When bounce-recording audio tracks, turn the metronome off (Metronome Setup “Sound”: Off).

Record

- Set “Location” to the beginning of the song (001: 01.000).

- Press the SEQUENCER REC/WRITE switch.

You will be in record-ready mode.

Once you press the SEQUENCER REC/WRITE switch, you will be unable to change the audio track selection in “Track Select.”

- Press the SEQUENCER START/STOP switch.

Playback will begin, and bounce-recording will also begin simultaneously.

When the audio tracks have finished playing back, recording will also end. Song playback will also end automatically.

Listen to the recorded result

- In the P0: Play/REC– Audio TRACK Mixer page, mute the playback of audio tracks 1 and 2.

– Audio Track 1 –

Play/Rec/Mute: Mute

Solo On/Off: Off

– Audio Track 2 –

Play/Rec/Mute: Mute

Solo On/Off: Off

- Press the SEQUENCER START/STOP switch to play back the song.

Make output settings for audio track 3 as described in “Listen to the recorded result” on page 104.

- Press the SEQUENCER START/STOP switch to stop playback.

If you want to create a WAVE file on the hard disk from a song that includes audio tracks, see “Resampling a song to create a Wave file” on page 145.

Recording automation events for pan, EQ, and volume etc. on an audio track

All audio track parameters (Pan, Volume, Send1/2, and EQ) can be recorded in realtime. In this example, we’ll record **Pan** and **Volume** changes on audio track 3.

Access the P0: Play/REC– Audio Track Mixer page, and use “Track Select” to select Audio Track 03 as the track to be recorded. You could use the VALUE controller to operate a desired parameter, but using the control surface lets you mix up to eight tracks simultaneously.

Setup

- Access the P0: Play/REC– Preference page.
- In Recording Setup, Recording Setup (Audio Track), choose the desired recording method.

In this example, we’ll choose overdub recording so that we can record repeated passes, adding more automation data on each pass.

– Recording Setup –

Overdub: on

– Recording Setup (Audio Track) –

Automation Only: checked

- If you record without checking “Automation Only,” audio events will also be recorded. Note that this will erase and overwrite the audio events that already exist.

- Access the P0: Play/REC– Control Surface page.

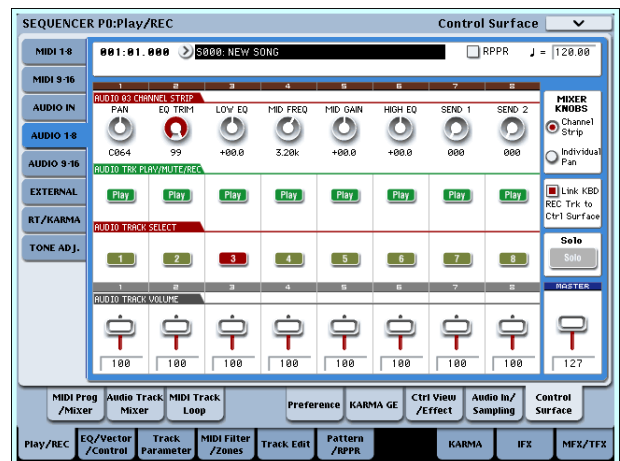

- Press the CONTROL ASSIGN AUDIO switch several times so that the HDR1–8 LED located at the right of the switch is lit.

- In the center of the right edge of the LCD, check “Link KBD REC Trk to Ctrl Surface.”

If you check this and press the MIX SELECT 3 switch, each knob will control audio track 3, and at the same time “Track Select” will switch to Audio Track 03.

Press the SEQUENCER START/STOP switch to play back, and operate the knobs and sliders etc. to rehearse your mix.

If MIXER KNOB is set to CHANNEL STRIP, knob 1 will control pan, knobs 2–6 will control EQ, and knobs 7 and 8 will control the send levels. Use slider 3 to adjust the volume of audio track 3.

When you’ve finished rehearsing, press the SEQUENCER START/STOP switch to stop. Press the LOCATE switch.

Record

- Press the SEQUENCER REC/WRITE switch.

The metronome will begin sounding, and you will be in record-ready mode.

7. Press the SEQUENCER START/STOP switch.

After a two-measure count, recording will begin. Use the sliders etc. to control the pan.

Note: When recording automation events, you can use quantization, the resolution setting, and the compare function in the same way as for a MIDI track.

8. When you're finished recording, press the SEQUENCER START/STOP switch to stop recording.

9. Listen to the recorded result.

Press the SEQUENCER START/STOP switch to play back.

If you want to record again, use the Compare function (press the COMPARE switch) to re-record.

10. If you want to continue adding automation events, repeat the recording procedure from step 6.

Placing a WAVE file in an audio track

You can play back a WAVE file by importing it into a region of an audio track.

Important: You can only directly import WAVE files from the internal hard drive. To use files from CDs or external USB devices, you must first copy them to the internal hard drive, and then import the copied file into the Song.

Note: You can only import WAVE files that have a 48 kHz sample rate, are monaural, and are less than 80 minutes long. If the WAVE file you want to import has a 44.1 kHz sampling rate, use the Disk mode "Rate Convert" command to convert the file to 48 kHz before you import it. For more information, see "Rate Convert" on page 724 of the Parameter Guide.

1. Select the P4: Track Edit page.
2. Use "Track Select" to select the audio track in which you want to place the WAVE file.
3. Choose the "Audio Event Edit" page menu command to open the dialog box.

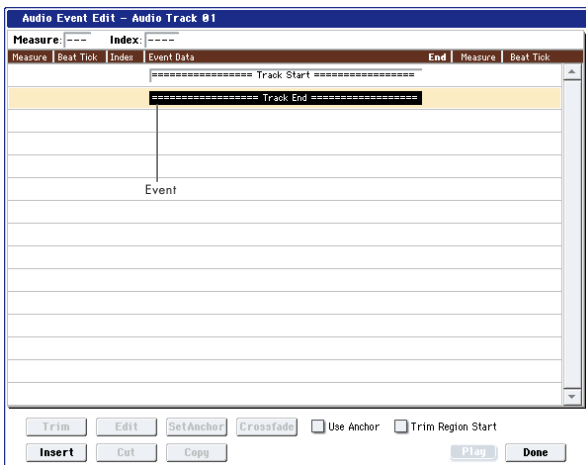

4. Select the event at which you want to insert a region, and press the Insert button located at the lower left. A dialog box will open.

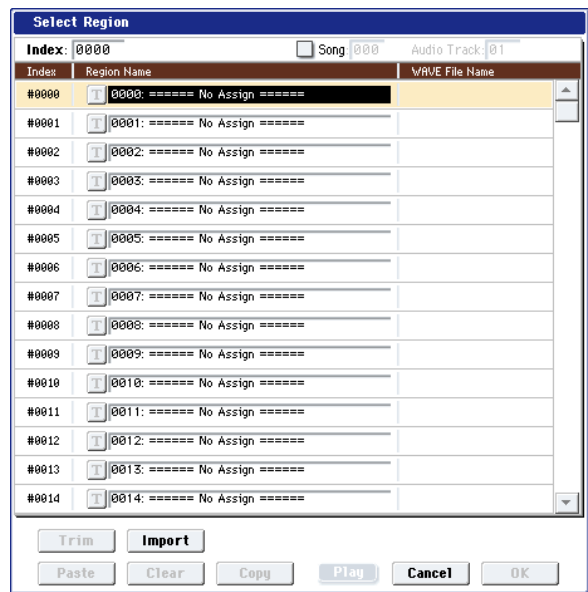

5. Select the region into which you want to import the WAVE file, and press the Import button located below. A dialog box will open.

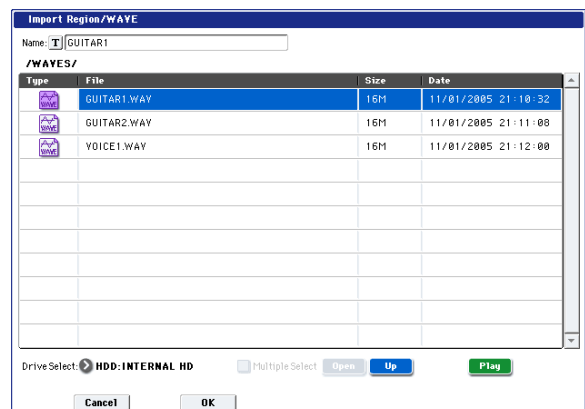

6. Use "Drive Select," "Open," and "Up" to navigate to the desired directory, select the WAVE file you want to import, and press the OK button to import the file into the region.

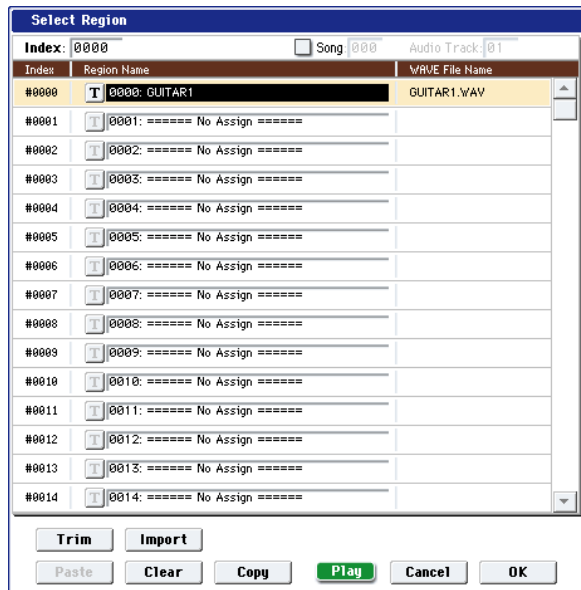

When selecting a WAVE file, you can press the Play button to audition the files to help you find the desired one.

You can also use the “Name” field located above to assign a name to the region. Edit the “Name” after you’ve selected a file.

Note: The OK button is available only if you’ve selected a 48 kHz monaural WAVE file. If you’ve selected a 44.1 kHz file or a 48 kHz stereo file, the button will be grayed-out and you won’t be able to press it.

The Play button is available only if you’ve selected a 48 kHz WAVE file.

- ⚠ Editing a region will affect the audio track for the entire song. Use caution when editing a region that’s already used in an audio track.

7. Press the OK button, the selected region will be placed in the audio track.

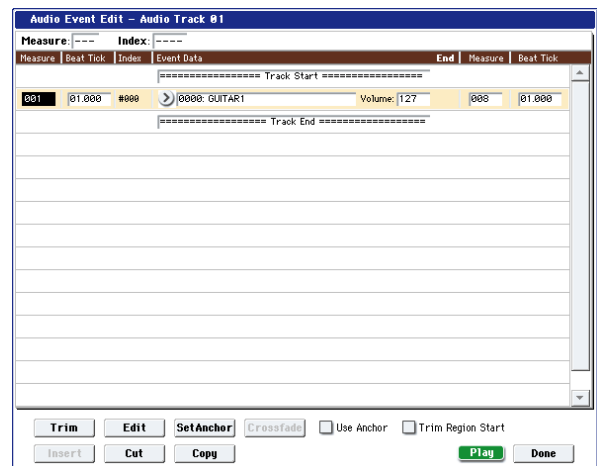

8. Select the event that you want to edit, and use the location parameters “Measure” and “Beat Tick” to edit the location of the event.

- ⚠ You can’t place two or more events at the same location.

9. Press the Done button.

10. Press the SEQUENCER START/STOP switch, and make sure that the WAVE file plays back.

You can press the COMPARE switch to return to the state prior to the edit you just performed.

We’ve kept this example simple, but you can also perform editing operations such as changing the playback position of the WAVE file in steps of a single sample, changing the location relative to an anchor point, or crossfading two audio events. For more information, see “Audio Automation Edit” on page 540 of the Parameter Guide.

Song editing

You can apply a variety of editing operations to a song. The available types of editing operation are listed below.

Song

Delete Song: This command deletes the currently selected song. For more information, see “Delete Song” on page 524 of the Parameter Guide.

Copy From Song: This command copies all of the setting data and musical data from the specified song to the currently selected song. For more information, see “Copy From Song” on page 524 of the Parameter Guide.

FF/REW Speed: This allows you to set the speed at which fast-forward or rewind will occur when you press the FF switch or REW switch. For more information, see “FF/REW Speed” on page 525 of the Parameter Guide.

GM Initialize: This command transmits a GM System On message to the Sequencer mode, resetting all MIDI tracks to the GM settings. For more information, see “GM Initialize” on page 526 of the Parameter Guide.

Auto HDR/Sampling Setup: This command automatically makes the appropriate two-channel mix settings etc. for hard disk recording, audio track bouncing, sampling/resampling (in-track sampling, etc.), or creating an audio CD. For more information, see “Auto HDR/Sampling Setup” on page 529 of the Parameter Guide.

Initialize: Set parameters related to hard disk recording and sampling to their default values.

HDR (Audio Track Recording): Make the necessary settings for recording external audio signals such as guitar or vocal from the audio inputs to audio tracks.

Bounce Audio Track: Make the necessary settings for bounce-recording audio tracks.

2ch Mix to Disk: Make settings for resampling a completed song in order to create a two-channel stereo WAVE file on the hard disk. (Use this if you want to create a WAVE file and then use the Disk mode Make Audio CD page to burn the file to an audio CD on the internal CD-R/RW drive.)

Resample SEQ Play: Make settings so that you can resample your keyboard playing in Sequencer mode.

In-Track Sampling: Make settings to sample only an external audio signal using the In-Track Sampling function.

Bounce All Tracks To Disk: This command resamples all tracks in the song to a single WAVE file (stereo). For more information, see “Bounce All Tracks To Disk” on page 534 of the Parameter Guide.

Set Song Length: This command changes the length of the specified song. When it is executed, the length of the master track will change, and the number of measures played will change. For more information, see “Set Song Length” on page 541 of the Parameter Guide.

MIDI Tracks

Tracks

MIDI Step Recording: It allows you to specify the length and velocity of each note numerically, and to input MIDI data, the pitches, from the keyboard. You can use the Rest button and Tie button to enter a rest or tie. For more information, see “MIDI Step Recording” on page 535 of the Parameter Guide.

MIDI Event Edit: Here you can edit individual events of MIDI data. For more information, see “MIDI Event Edit” on page 536 of the Parameter Guide.

Bounce Track: This command combines the musical data of the bounce source and bounce destination tracks, and places the combined data in the bounce destination. All musical data in the bounce source will be erased. For more information, see “Bounce Track” on page 542 of the Parameter Guide.

Create Control Data: This command creates control change, aftertouch, pitch bend, or tempo data in the specified region of a MIDI track or the master track. For more information, see “Create Control Data” on page 547 of the Parameter Guide.

Erase Control Data: This command erases data such as control changes, after touch, pitch bend, or tempo in the specified range. For more information, see “Erase Control Data” on page 547 of the Parameter Guide.

Quantize: This command corrects the timing of MIDI data of the type you specify (note data, control change, aftertouch, pitch bend, program change, etc.) in the track. For more information, see “Quantize” on page 548 of the Parameter Guide.

Shift/Erase Note: This command shifts (moves) or erases the specified note numbers in a specified MIDI track and range of measures. For more information, see “Shift/Erase Note” on page 549 of the Parameter Guide.

Modify Velocity: This command modifies the velocity values of notes in the specified area so that they will change over time according to a selected curve. For more information, see “Modify Velocity” on page 549 of the Parameter Guide.

Pattern

Step Recording (Loop Type): Here you can perform step recording into a pattern. For more information, see “Step Recording (Loop Type)” on page 554 of the Parameter Guide.

Event Edit: Here you can edit individual events of the musical data in a pattern. For more information, see “Event Edit” on page 554 of the Parameter Guide.

Pattern Parameter: This command specifies the number of measures and the time signature of the selected pattern. For more information, see “Pattern Parameter” on page 554 of the Parameter Guide.

Erase Pattern: This command erases the data from the selected pattern. For more information, see “Erase Pattern” on page 554 of the Parameter Guide.

Copy Pattern: This command copies the settings and musical data of the selected pattern to another pattern. For more information, see “Copy Pattern” on page 554 of the Parameter Guide.

Bounce Pattern: This command combines the musical data of the bounce source pattern and bounce destination pattern, and places the combined musical data in the bounce destination. For more information, see “Bounce Pattern” on page 555 of the Parameter Guide.

Get From MIDI Track: This command takes musical data from a MIDI track and loads it into the specified pattern. For more information, see “Get From MIDI Track” on page 555 of the Parameter Guide.

Put To MIDI Track: This command places a pattern into a MIDI track. For more information, see “Put To MIDI Track” on page 555 of the Parameter Guide.

Copy To MIDI Track: This command copies the specified area of musical data from the specified pattern to a MIDI track as musical data. For more information, see “Copy To MIDI Track” on page 556 of the Parameter Guide.

Common to MIDI tracks and audio tracks

Erase Track: This command erases the data from the specified track. It is not possible to erase the master track by itself. For more information, see “Erase Track” on page 541 of the Parameter Guide.

Copy Track: This command copies musical data from the copy source track to the specified track. For more information, see “Copy Track” on page 542 of the Parameter Guide.

Erase Measure: This command erases the specified type(s) of musical data from the specified range of measures. The Erase Measure command can also be used to remove only a specific type of data. Unlike the Delete Measure command, executing the Erase Measure command does not cause the subsequent measures of musical data to be moved forward. For more information, see “Erase Measure” on page 542 of the Parameter Guide.

Delete Measure: This command deletes the specified measures. When the Delete Measure command is executed, the musical data following the deleted

measures will be moved towards the beginning of the sequence. For more information, see “Delete Measure” on page 543 of the Parameter Guide.

Insert Measure: This command inserts the specified number of measures into the specified track. When you execute the Insert Measure command, the musical data following the insert location will be moved backward. For more information, see “Insert Measure” on page 544 of the Parameter Guide.

Repeat Measure: This command repeatedly inserts the specified measures for the specified number of times. When you execute the Repeat Measure command, the measures will be inserted following the measure specified by “To End of Measure,” and musical data following the inserted data will be moved backward. For more information, see “Repeat Measure” on page 545 of the Parameter Guide.

Copy Measure: This command copies the measures of musical data specified as the “From” source to the beginning of the measure specified as the “To” location. When you execute the Copy Measure command, the existing track data at the copy destination will be rewritten. For more information, see “Copy Measure” on page 546 of the Parameter Guide.

Move Measure: This command moves the specified measures of performance data to another measure. When you execute the Move Measure command, the performance data following the move-source measures will move forward by the corresponding number of measures, and the performance data following the move-destination will move backward (i.e., later in the song) by the same number of measures. For more information, see “Move Measure” on page 546 of the Parameter Guide.

Audio Tracks

Audio Event Edit: This command lets you edit individual audio events that have been recorded, or trim (i.e., make adjustments in steps of a single sample to) the region used by audio events. For more information, see “Audio Event Edit” on page 537 of the Parameter Guide.

Audio Automation Edit: This lets you edit individual automation data events. For more information, see “Audio Automation Edit” on page 540 of the Parameter Guide.

Region Edit: Here’s how to edit the regions used in an audio track. In addition to Importing or Pasting a region, you can use the Trim dialog box to specify the range in which a WAVE file will play back. For more information, see “Region Edit” on page 550 of the Parameter Guide.

Volume Ramp: This command modifies the data values (volume) of the specified area. You can gradually increase (Fade In) or decrease (Fade Out) the volume between the start and end points. For more information, see “Volume Ramp” on page 552 of the Parameter Guide.

Copy Song’s Tempo to Region: This command changes the tempo used by the specified regions of audio events so that the audio event tempo will match the tempo of the location in which those regions play back.

If the tempo of an audio track matches the tempo of the MIDI tracks, executing this command to match the region tempo will ensure that the “Adjust Region to Song’s Tempo (Time Stretch)” or “Adjust Song’s Tempo to Region” commands can be executed correctly. For more information, see “Copy Song’s Tempo to Region” on page 553 of the Parameter Guide.

Adjust Song’s Tempo to Region: This command creates tempo events in the master track to match the tempo of the regions used by the audio events in the specified range.

This is useful if you create audio tracks in a previously-recorded region, and want all tracks (including MIDI tracks) to match that region. For more information, see “Adjust Song’s Tempo to Region” on page 553 of the Parameter Guide.

Adjust Region to Song’s Tempo (Time Stretch): If the tempo of regions used by audio events in the specified range differs from the tempo of the range in which those regions play back, you can execute Time Stretch (Sustaining) to create new WAVE files and regions. Audio events that use the newly created regions will also be created automatically.

If you want to modify the tempo of an existing song, it is convenient to first specify the desired tempo in the master track, and then execute this command so that the audio track(s) will be created according to the new tempo. For more information, see “Adjust Region to Song’s Tempo (Time Stretch)” on page 553 of the Parameter Guide.

Using RPPR (Realtime Pattern Play/Record)

Assign	Bank	Pattern Name	Track Name	Mode	Shift	Sync	Info.
C#2	Preset	P000: Pop&Balad 1/Stc	T01: MIDI TRACK 01	Manual	+00	Measure	I-A004: Studio Stand
D2	Preset	P001: Pop&Balad 2/Stc	T01: MIDI TRACK 01	Manual	+00	Measure	I-A004: Studio Stand
D#2	Preset	P002: Pop&Balad 3/Stc	T01: MIDI TRACK 01	Manual	+00	Beat	I-A004: Studio Stand

This section explains how to assign a pattern to RPPR, and how to play and record.

Creating RPPR data

1. Create a new song, and choose a drum program for MIDI track 1.
2. Select the RPPR Setup tab of the P5: Pattern/RPPR page. In this page, the RPPR function is automatically turned on.

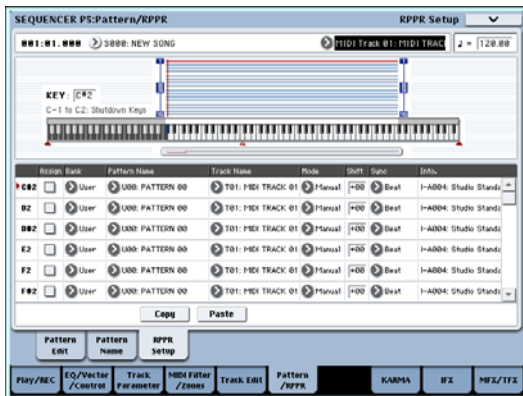

3. Select the key to which the pattern will be assigned.

Select C#2. Hold down the ENTER switch and play a key, or use the scroll bar located at the right to find the key.

Note: C2 and lower keys are used to stop playback, and cannot be assigned.

4. Check "Assign" for C#2.
5. Set "Bank" to Preset, and set "Pattern Name" to P00.

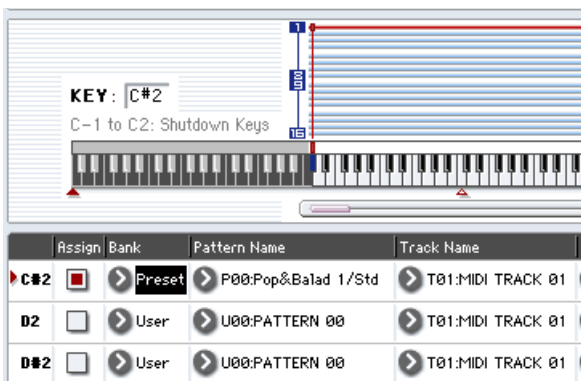

6. Set "Track Name" to T01.

The selected pattern will be played according to the settings (program, etc.) of the track you select here.

7. With the C#2 parameter selected, press the Copy button.

8. Assign patterns to other keys.

Select the D2 parameter, and press the Paste button.

The "Assign," "Bank," "Pattern Name," "Track Name," "Mode," "Shift," and "Sync" settings you made in steps 5 and 6 will be copied automatically.

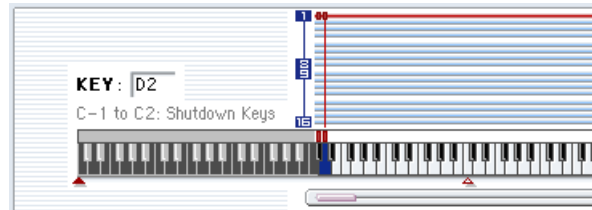

9. Modify only the "Pattern Name." Select "Pattern Name," and press the Δ switch to select P01.

10. Select the D#2 parameter, and press the Paste button.

The "Assign," "Bank," "Pattern Name," "Track Name," "Mode," "Shift," and "Sync" settings you made in steps 5 and 6 will be copied automatically.

As you did in step 9, set "Pattern" to P02.

Note: When making RPPR settings, you can use the Copy button and Paste button in this way to efficiently assign the "Bank," "Pattern Name," and "Track Name" etc. to each key.

11. As described above, assign several other patterns such as P03 and higher.

12. Press the C#2 key. The assigned pattern will play.

Take your finger off the C#2 key, and press the D2 key. The pattern will change, and playback will begin. At this time, the pattern operation will depend on the "Sync" and "Mode" setting.

Set "KEY" to C#2, and set "Sync" to Measure. Make the same setting for D2 (See the diagram above).

Now press the notes consecutively. Notice that the patterns operate in a different way.

With the "Measure" setting, patterns will be handled in one-measure units. The second and subsequent patterns will start in sync with the end of previously played pattern.

If you change the "Mode" setting to **Once**, the entire pattern will playback to the end even if you release your finger from the keyboard immediately.

13. To stop playback, either press the same key once again, or press the C2 or lower key.

Assign	Bank	Pattern Name	Track Name	Mode	Shift	Sync	Info.
C#2	Preset	P000: Pop&Balad 1/Stc	T01: MIDI TRACK 01	Manual	+00	SEQ	I-A004: Studio Stands
D2	Preset	P001: Pop&Balad 2/Stc	T01: MIDI TRACK 01	Manual	+00	SEQ	I-A004: Studio Stands
D#2	Preset	P002: Pop&Balad 3/Stc	T01: MIDI TRACK 01	Manual	+00	SEQ	I-A004: Studio Stands

RPPR playback

Let's use the RPPR you created to perform in the P0: Play/REC– MIDI Track Prog Select/Mixer page.

1. Select the P0: Play/REC– MIDI Track Prog Select/Mixer page (See the diagram below).
2. Check the "RPPR" check box.

The RPPR function will be turned on. Set the on/off for each song.

3. Play the keyboard, and patterns will begin playing according to the RPPR settings.

- Pattern playback for a key with a "Sync" setting of Beat or Measure will sync to the playback of the first pattern. For more information, see "Sync" on page 493 of the Parameter Guide.
- If you are playing the pattern in synchronization (when "Sync" is Beat, Measure, or SEQ), the pattern will start accurately if you play the note slightly earlier than the timing of the beat or measure. Even if you play the note slightly later than the beat or measure (but no later than a 32nd note), it will be considered to have started at the beat or measure, and the beginning of the pattern will be compressed so that the remainder of the playback will be correct.

If you wish to trigger the RPPR function from an external MIDI device, use the MIDI channel that is selected for "Track Select."

4. To turn off the RPPR function, uncheck the RPPR check box.

⚠ Synchronization will be lost if you use the << REW or FF >> switches while a song is playing.

Note: If you want RPPR pattern playback to begin at the moment that song playback begins, it is a good idea to insert an empty measure containing no musical data before the song playback begins.

Note: If the song is stopped, the pattern will synchronize to the timing of the KARMA function.

Recording an RPPR performance

You can record RPPR performances in real-time.

If you are using only one track (such as MIDI Track 01), set "Track Select" to the desired track, and un-check Multi Rec.

On the other hand, even if RPPR uses only one track, use multi-track recording if you will be selecting another track in "Track Select" and recording its performance at the same time.

You should also select multi-track recording if you specified the RPPR data using multiple tracks rather than just a single track, and want to simultaneously record the performance of multiple tracks.

Note: The RPPR pattern will be recorded as performance data on the tracks used by the pattern.

In this example, we'll explain how you can record an RPPR performance and a keyboard performance at the same time. Before you continue, use the P0: Play/REC– MIDI Track Prog Select/Mixer page to assign a drum program to MIDI track 1, and a bass program to MIDI track 2.

1. Assign several keys starting with C#2 to preset patterns. Check the C#2 "Assign" setting, and set "Bank" to Preset and "Pattern Name" to the desired preset pattern. For "Track Name," select MIDI track 1 (T01) to which you assigned a drum program.
2. For each RPPR pattern, set "Sync" to SEQ (See the diagram above).

Play RPPR while a song plays back

RPPR can be played in synchronization with the playback of a song.

Pattern playback for a key with a "Sync" setting of SEQ will synchronize to the playback of the song. (See "Sync" on page 493 of the Parameter Guide.) Start the song playback, and then press the key. The pattern playback will start in synchronization with the measures of the song.

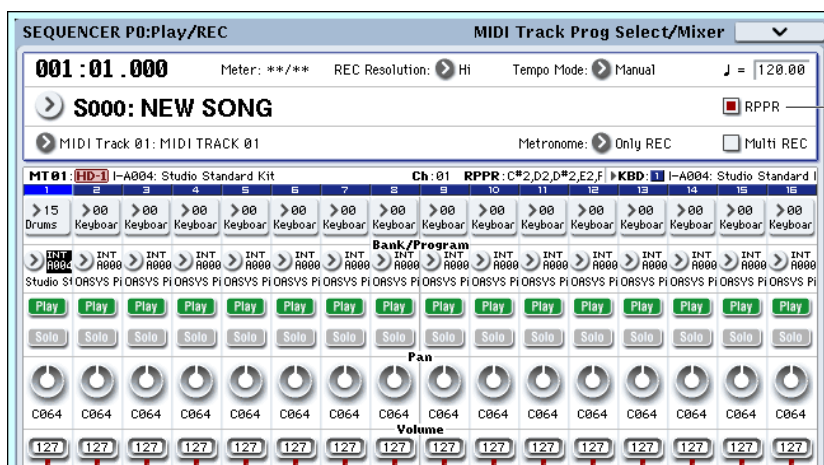

With a setting of SEQ, patterns played by the RPPR function while the sequencer is playing or recording will start in synchronization with the measures of the sequencer.

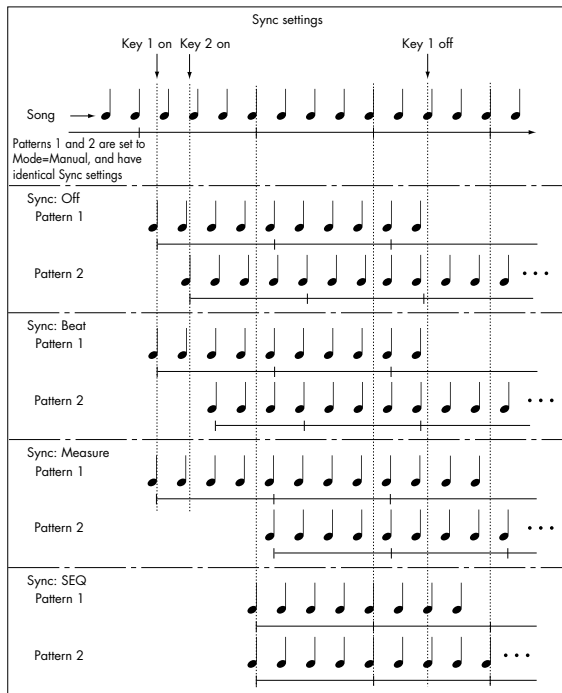

3. Select the P0: Play/REC– MIDI Track Prog Select/Mixer page.
4. Check the “RPPR” check box, and set “Track Select” to MIDI Track 02.

When the RPPR function is on, pressing a key to which a pattern is assigned will cause the assigned pattern to start playing, regardless of the track that’s selected in “Track Select.”

Keys to which patterns are not assigned can be played in the usual way. You can play the program that’s assigned to the MIDI track you select here.

5. Since you want the tracks you play via RPPR and the track you play from the keyboard to be recorded at the same time, check the Multi REC check box.

Note: If Recording Setup is set to “Loop All Tracks,” it will not be possible to select Multi REC. Set the Recording Setup to Overwrite.

6. Press the SEQUENCER REC/WRITE switch to enter record-ready mode.
7. For the tracks you will be recording (MIDI Track 1, 2), press Play/Rec/Mute to make them indicate REC.
8. Press the LOCATE switch to set the location to 001:01.000.
9. Press the SEQUENCER START/STOP switch, and then press a key that plays an RPPR pattern.

If, during the pre-count before recording, you press a key that’s assigned to an RPPR pattern, the pattern will begin playing (and being recorded) the moment that recording begins.

Record the RPPR pattern playback and keyboard performance.

⚠ When recording the playback of patterns triggered by RPPR, the timing of the recorded events may be slightly skewed. If this occurs, try setting “REC Resolution” to a setting other than Hi.

10. When you are finished performing, press the SEQUENCER START/STOP switch.

Recording will end, and the sequencer will return to the location at which recording began.

If you made a mistake during your performance or would like to re-record, you can use the Compare function (press the COMPARE switch) to re-record as many times as you wish.

11. If you want to record other tracks, un-check the Multi REC (See step 5) or “RPPR” (See step 4) check boxes as necessary.

Sampling in Sequencer mode

Sampling is still available in Sequencer mode - which can be very convenient. The main areas of functionality are summarized below. For more information, see “Examples of sampling in Sequencer mode” on page 143.

- Multisample etc. you create can be played back in Sequencer mode together with internal programs. The Time Slice function of Sampling mode lets you

divide up a rhythm loop sample, and create playback data that triggers the divided samples at the appropriate timing. You can play back this performance data in Sequencer mode, and adjust the playback tempo without affecting the pitch of the rhythm loop sample. You can even exchange the note numbers of the performance data or

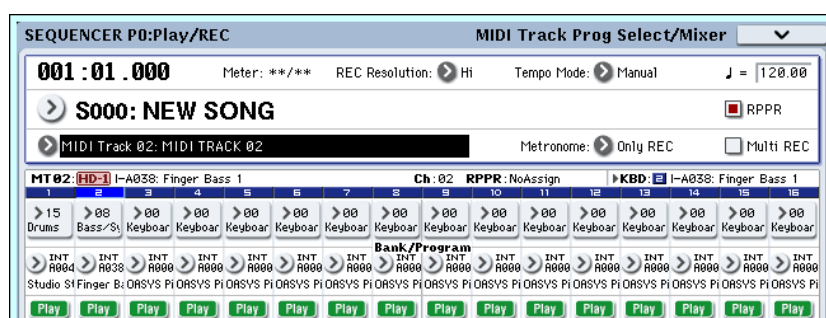

change its timing to transform the original rhythm loop sample into a completely new rhythm loop.

- The In-Track Sampling function lets you sample an external audio source that's playing along with the

song playback, and automatically create note data in the track to play this sample at the correct time.

- You can resample your completed songs to WAVE files, and create an audio CD by burning those WAVE files in Disk mode.

Saving your song

This section explains how to save your song on the internal hard disk.

To ensure that your data will be reproduced perfectly, we recommend that you use "Save All" to save your song. When you use "Save All," the following data will be saved.

- Programs, combinations, global settings, drum kits, and wave sequences from internal memory
- Song data
- Multisamples and samples you create in Sampling mode, etc.

Note: The WAVE files you created by recording audio tracks will be moved to a different directory. (See "How audio data is stored on the disk" on page 96)

- ⚠ When you turn off the power, the Sequencer mode settings, the recorded songs, and the user pattern data will be lost.

To save your data, proceed as follows.

1. Make sure that the media is able to save data. ("Setting up media")
2. Press the MODE DISK switch to enter Disk mode.
3. Select the Disk-Save page. Press the File tab, and then the Save tab.
4. Make sure that "Drive Select" is set to HDD:INTERNAL HD.
5. If the drive contains directories, select the directory in which you want to save the data.

Press the Open button to move to a lower level of the directory structure, or the Up button to move to a higher level.

If you want to create a new directory, move to the level at which you want to create the directory, and execute the Utility page menu command "Create Directory."

6. Press the page menu button to access the page menu, and press "Save All." If you've chosen "Save All," .PCG, .SNG, and .KSC files will be saved.

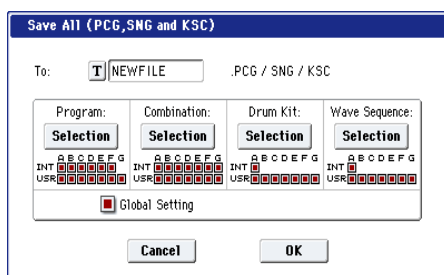

7. Use the text edit button to enter the filename with which you want to save the data.
8. Press the OK button to execute the Save operation.

9. When saving is complete and you return to the Save page, the LCD screen will show the file that was saved.

The various types of data are saved as the following files.

.PCG file

Programs, combinations, drum kits, wave sequences, and global settings from internal memory

.SNG file

Sequencer song data

Note: If audio track recording data exists, the region data will also be saved at the same time. Inside the directory that contains the .SNG file, a directory will be created with a name consisting of first six characters of the .SNG filename plus "_A", and the WAVE files will be copied to this directory.

.KSC file

A file that lists the multisamples and samples

Directory

The multisamples (.KMP files) and samples (.KSF files) listed in the .KSC file are stored within a directory on the media.

The data will be saved to the media you specified, and you will return to the Save page.

The time required for saving will depend on the amount of data.

If the media contains an identically-named file, you will be asked whether you want to overwrite the existing data. Press the OK button if you want to overwrite the data that's already on the media. If you don't want to overwrite the existing data, press the Cancel button, return to step 6, rename the data in step 7, and save it again.

Saving a template song

If you want the programs, track parameters, effect settings, and KARMA settings etc. used by a song to be saved as a Template song, use the "Save Template Song" page menu command to save these settings.

Cautions and other functions in Sequencer mode

OASYS sequencer file formats

The OASYS sequencer supports both the proprietary OASYS Song format, and Standard MIDI Files.

If you like, you can convert data between the two formats, simply by loading the data in one format and then saving it in the other.

For more information, see “Save to Standard MIDI File” on page 719 of the Parameter Guide, and “Save SEQ” on page 718 of the Parameter Guide.

OASYS Song format

This is the native OASYS sequencer format, which is required to ensure that all OASYS-specific data is saved correctly.

Standard MIDI Files

You can also load and save Standard MIDI Files (SMF), for compatibility with other sequencers. Note that some OASYS-specific data may not be maintained when in SMF files.

GM, XG, and GS System Exclusive Data

The OASYS sequencer can record System Exclusive messages, including XG or GS data. For more information, see “System Exclusive events supported in Sequencer mode” on page 560 of the Parameter Guide.

- Note that GM, XG, and GS exclusive messages do not affect the OASYS when they are played back.

The Compare function

When you perform realtime recording, step recording, or track editing, this function allows you to make before-and-after comparisons.

If you continue editing when the COMPARE switch is lit, the key will go dark. This now becomes the musical data that will be selected when the COMPARE switch is dark. Any previous unsaved edits will be lost.

Operations for which Compare is available

In general, MIDI track, audio track and pattern event data can not be returned to its original state.

Comparing song parameters is possible only during song editing (when executing a page menu command).

- Recording to a MIDI track
- Recording to a audio track
- Track Edit

All commands except for the page menu commands “Memory Status,” “FF/REW Speed” and “Set Location” of the P4: Track Edit– Track Edit page.

- Recording to a pattern
- Pattern Edit

All commands except for the page menu commands “Memory Status” and “FF/REW Speed” of the P5: Pattern/RPPR– Pattern Edit page.

- Song Edit

P0–P3 and P7–P9 pages: Page menu commands “Delete Song” and “Copy From Song”

Comparing after sampling

The Compare operation will also apply to multisamples and samples that were sampled with “Convert to” enabled in “Select Sample No.,” as described on page 528 of the Parameter Guide. This means that if you want to re-do your sampling, you can press the COMPARE switch to return the multisample and samples to the state prior to sampling, and unwanted samples will not remain.

- The program will not be affected by the Compare, and will not return to its prior state.
- WAVE files are not deleted when you compare edits to audio tracks. To delete a WAVE file you no longer need, use the menu command “Delete Unused WAV Files,” as described on page 722 of the Parameter Guide.

Operations for which Compare is not available

- Editing song parameters
- Page menu commands other than those listed under “Operations for which Compare is available,” above.

Memory Protect

Before you record a track or pattern, or edit the musical data, you will need to turn off the memory protect setting in Global mode. For more information, see “Memory protect” on page 167.

About MIDI

Track status

You can specify whether each track will use the internal OASYS sounds, or use an external MIDI tone generator.

When the Track **Status** (P2– MIDI page) is set to INT or BTH, operating OASYS’s keyboard and controllers will sound and control OASYS’s own tone generator.

When **Status** is set to EXT, EX2 or BTH, operating OASYS’s keyboard and controllers will sound and control the external tone generator. (The MIDI channel of the external tone generator must match the **MIDI Channel** of the track that is set to EXT, EX2 or BTH.)

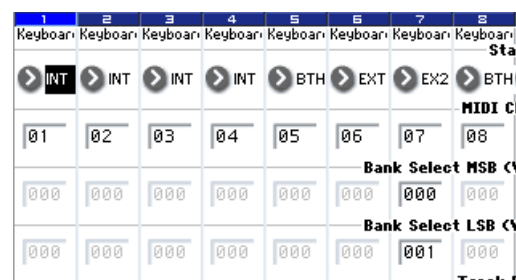

If you wish to use the Sequencer mode of the instrument as a 16-track multi-timbral tone generator, select INT or BTH. For more information, see “Status” on page 466 of the Parameter Guide.

Synchronizing the sequencer with an external MIDI device

The record/playback tempo of OASYS’s sequencer can be synchronized to an external MIDI device such as a sequencer or rhythm machine. For more information, see “Synchronizing the playback of the KARMA function or sequencer” on page 1011 of the Parameter Guide.

Sampling (Open Sampling System)

Sampling Overview

About sampling on the OASYS

The OASYS can sample external audio from the analog or S/P DIF inputs, at 48 kHz 16-bit resolution, in mono or stereo. You can record samples into RAM, or sample directly to disk.

You can also digitally resample the complete sound of a Program, Combi, or Song, played live or sequenced, including any effects and KARMA-generated events.

Finally, you can also sample (or “rip”) directly from an audio CD, in the digital domain.

Once a sample is loaded into RAM, you can use it directly in Drum Kits, or make it into a Multisample and use it anywhere that you use ROM Multisamples, such as in HD-1 Programs or Wave Sequences.

Sampling and RAM

The OASYS comes with 1 GB of RAM pre-installed, which can be expanded up to 2 GB with a user-installable DIMM module. This memory is shared between the operating system, ROM and EXs samples, and RAM samples.

In particular, the size of the currently loaded EXs samples trades off against the memory available for RAM samples. The more space used by the EXs samples, the less is available for RAM samples.

You can choose which EXs are loaded, if any, by using the Expansion Sample Setup menu command, on the Global mode Basic Setup page. For more information, see “Expansion Sample Setup” on page 684 of the Parameter Guide.

EXs samples and available sample RAM

EXs Loaded	Available Sample RAM	
	1GB installed	2GB Installed
None	500 MB	~1.5 GB
EXs1 ROM Expansion	187 MB	~1.2 GB
EXs2 Concert Grand Piano	0 MB	~1 GB

Note: To check the amount of sample RAM available, see “0-1f: Free Sample Memory/Locations” on page 572 of the Parameter Guide.

The amount of sampling time depends on the amount of free RAM, as shown below:

Free RAM and approximate sampling times

Free RAM	Approximate Sampling Time (min:sec)	
	Mono	Stereo
16 MB	2:54	1:27
64 MB	11:39	5:49
128 MB	23:18	11:39
256 MB	46:36	23:18

Free RAM	Approximate Sampling Time (min:sec)	
	Mono	Stereo
512 MB	93:12	46:36

Installing additional RAM

You can install additional RAM, up to a total of 2 GB. For more information, see “Installing memory” on page 1038 of the Parameter Guide.

Sampling to disk

You can sample directly to disk, creating a WAVE file. This lets you record up to 80 minutes continuously, in either mono or stereo (mono: approximately 440 MB, stereo: approximately 879 MB).

As long as they fit into the available RAM, these WAVE files can then be loaded into RAM and used in Drum Kits, HD-1 Programs or Wave Sequences.

WAVE files can also be used in audio tracks of the sequencer, or used to create an audio CD. For more information, see “Audio recording” on page 96, and “Creating and playing audio CDs” on page 175.

The OASYS features an Open Sampling System that supports a wide range of sources and formats as described below.

Sampling mode

- 1) Analog audio signals from a mic or audio device connected to the AUDIO INPUT jacks can be converted into digital signals and sampled. You can also apply effects while sampling.
- 2) Digital audio signal from a digital audio device connected to the S/P DIF jack can be sampled directly. You can also apply effects while sampling. The S/P DIF input/output jacks support sample rates of 48 kHz and 96 kHz.
- 3) Digital audio signals from an audio CD in the internal CD-R/RW drive (or a USB-connected CD-R/RW drive) can be sampled directly (“ripped”).
- 4) Samples can be processed through effects and internally sampled again (“resampled”). You can use either “Auto” mode which automatically applies the specified effect processing to the sample you specify, or “Manual” mode which lets you play the sample manually with effects applied and resample your performance.

Program, Combination, Sequencer modes

- 1) You can resample a performance that uses the functionality (filters, effects, KARMA function, sequencer, etc.) of each mode.

2) You can sample external audio sources via the OASYS' input jacks (see "Sampling mode" 1 and 2, above). At this time, you can mix the OASYS' own performance with the audio signals from the external source and sample the combined result, or you can monitor the performance of the OASYS while sampling only the external source from the input jacks.

3) In Sequencer mode when you sample an external audio source that's playing along with the song playback, note data will be automatically created in a track to trigger this sample at the appropriate moment in the song. This means that you can sample your vocal or guitar performance while playing back the sequencer. This is called the In-Track Sampling function.

Sampling frequency and bit resolution

As shown in the diagram, sampling reads the level of the analog signal at fixed intervals along the time axis, and stores the levels in memory as digital data.

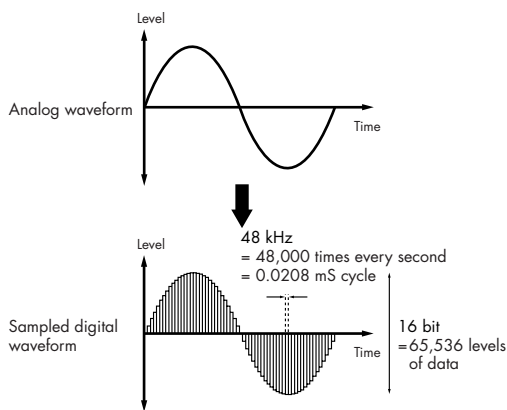

The "fixed intervals" mentioned above are generally expressed as the "sampling frequency." 48 kHz (kilohertz) means that sampling is performed 48,000 times each second, and that the interval is $1 \text{ (second)} / 48,000 \text{ (times)} = \text{approximately } 0.00002083 \text{ (seconds)} = \text{approximately } 0.02083 \text{ mS (millisecond)}$.

The higher the sampling frequency is, the closer to the original analog signal the waveform in memory will be.

Each level is read, and converted into digital data. The accuracy at this time is determined by the bit resolution. This process converts an analog signal with infinite resolution into a digital signal with finite resolution. With 16 bit resolution, each level is indicated in 65,536 steps (the sixteenth power of two).

The greater the bit resolution is, the closer to the original analog signal the waveform in memory will be.

48 kHz 16 bit sampling is the same quality as in audio devices such as DAT. A CD uses 44.1 kHz 16 bit sampling, which is a slightly lower sampling frequency.

How Sampling mode is organized

This section describes how sampling on the OASYS is organized. (See the diagram below)

Samples and Multisamples

Samples

The data that is recorded (sampled) into internal memory or loaded from a file is referred to as a sample or sample file. Samples consist of the actual waveform data, and parameters that specify how the data will be played back, such as Start, Loop Start, and End Address. Samples can be used in multisamples and drum kits.

The OASYS can hold a maximum of 4,000 samples in its internal memory.

The OASYS can share a single waveform among multiple samples. This allows you to create multiple samples with different playback addresses from the same waveform without wasting internal memory. For example, suppose that you have waveform data that records a voice saying "One-Two-Three." This single piece of waveform data could be shared by three samples, with the playback of sample A producing "One-Two-Three," sample B producing "One-Two," and sample C producing "Two-Three."

For more information, see "Copy" on page 624 of the Parameter Guide.

Conceptual diagram of the Open Sampling System

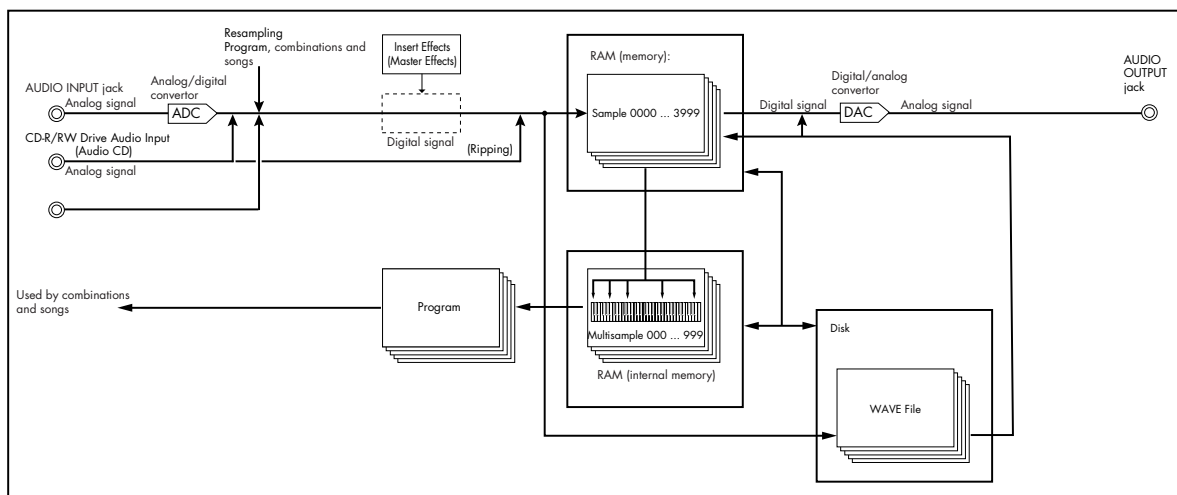

Multisamples

Multisamples lay out one or more Samples across the keyboard. For instance, a very simple guitar Multisample might have six Samples—one for each string.

Each Sample is contained in an Index, which includes parameters for the key range, original Sample pitch, tuning, level, and so on.

Multisamples can have up to 128 Indexes.

Using multisamples

When sampling an instrument that is able to produce a wide range of pitches, such as a piano, recording just one sample and applying it (playing it back) over the entire pitch range will not produce a natural-sounding result. By using a multisample you can record separate samples for each pitch range, and assign these samples to their respective pitch ranges to avoid any unnatural sounds during playback.

All of the instrumental sounds in the OASYS's internal preset multisamples are constructed in this way. For example, you might record one sample per octave, and assign each of these samples to an index (keyboard area).

By assigning multiple samples such as phrase samples or rhythm loops to a multisample and arranging them across the keyboard, you can play multiple samples simultaneously. You can assign different phrases to

each key or pad. Alternatively, these samples could be assigned at one-octave intervals, and played as phrase variations with different playback pitches.

The OASYS can hold a maximum of 1,000 multisamples in its internal memory.

A multisample can be selected as the oscillator and wave sequence for a program, and played as a program. In a combination, they can be combined with preset programs, and used in a multi. They can be used with the KARMA function to produce interesting results (for example, by using the KARMA function to automatically play sound effects or spoken samples).

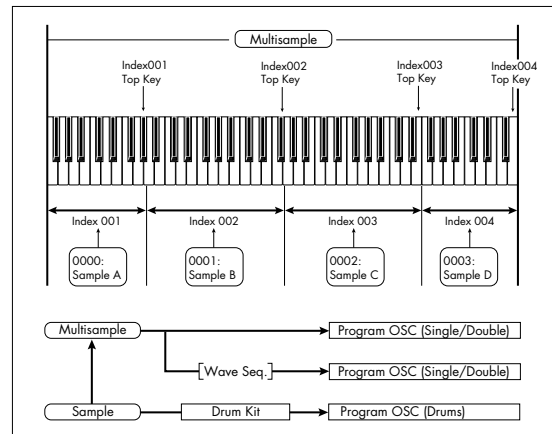

Preparations for sampling

Audio input settings

Input/Audio input

Input 1...4, S/P DIF L, S/P DIF R

Input 1...4: These are the input settings for analog audio devices connected to the INPUT 1–4 jacks.

The INPUT 1 and 2 jacks provide both XLR and 1/4" TRS balanced connectors. They can accept either mic-level or line-level signals.

Set the MIC/LINE switch appropriately for the device that's connected, and use the LEVEL knob to adjust the gain.

Choose the LINE setting (switch in the inward position) if you've connected a mixer, computer, audio system, signal processor, or another sequencer. Choose the MIC setting (switch in the outward position) if you've connected a mic. If you are using a condenser mic that requires phantom power, turn the PHANTOM POWER switch on. Otherwise, leave this switch off.

- ⚠ Never connect an unbalanced instrument, device, or mic to the XLR jacks when phantom power is turned on.

The INPUT 3 and 4 jacks can only input line-level signals from instruments or other devices. These are unbalanced 1/4" phone jacks.

Note: Guitars with active pickups can be connected directly to any of the inputs. Guitars with passive pickups (i.e., guitars that do not have an internal

preamp) can be used with inputs 1 and 2, but the impedance mismatch will cause both a change in tone and a reduction in volume. For best results, route such guitars through a pre-amp or effects unit before connecting them.

S/P DIF L, S/P DIF R: These are the input settings for digital input from an instrument or DAT player etc. connected to the S/P DIF IN jack. The S/P DIF input and output of the OASYS support 48 kHz and 96 kHz sample rates. Make this selection in "S/P DIF Sample Rate." 96 kHz sample rate data is converted to 48 kHz when it is sampled.

- ⚠ When using S/P DIF, make sure that the **System Clock** is set correctly. For more information, see "System Clock" on page 644 of the Parameter Guide.

Bus Select (IFX/Indiv.)

This specifies the bus for the external audio input signal.

L/R: The external audio input signal will be sent to the L/R bus. Choose this if you want to sample the performance of the OASYS itself along with the other signals of the L/R bus. Set **Source Bus** to L/R. Normally you will use this when you sample in Sampling mode.

IFX1...12: The external audio input signal will be sent to the IFX1–12 bus. Choose one of these settings if you want to apply an insert effect while recording. Set the **Source Bus** to match the **Bus Select** that follows the insert effect.

1...8: The external audio input signal will be sent to INDIVIDUAL 1, 2, 3, 4, 5, 6, 7, or 8 in monaural.

1/2...7/8: The external audio input signal will be sent via the **Pan** setting to INDIVIDUAL 1 and 2, 3 and 4, 5 and 6, or 7 and 8 in stereo. Set **Source Bus** to the corresponding Indiv. input.

Off: The external audio signal will not be sent to a bus. In Sampling mode, if you want to sample an external audio signal directly without routing it through a bus, go to the P0: Recording– Audio Input page, and choose the external input you want to sample (Audio Input 1–4, S/P DIF L, S/P DIF R) as the “Source Bus.”

 Please note that when you change **Bus Select (IFX/Indiv.)** from Off to L/R or IFX, the volume level to the AUDIO OUT L/MONO and R jacks or to the headphones may dramatically increase.

FX Ctrl Bus (FX Control Bus)

The FX Control Buses lets you create effects “sidechains.” Sidechains let you control an effect with one audio signal (the sidechain), while the effect processes a completely different audio signal. This is convenient for use with vocoders, compressors and limiters, gates, etc.

OASYS includes two true- stereo FX Control Buses. For more information, see “FX Control Buses” on page 730 of the Parameter Guide.

REC Bus

This sends the external audio input signal to the REC buses (four mono channels; 1, 2, 3, 4).

The REC buses are dedicated internal buses used for sampling or for recording audio tracks in Sequencer mode.

If you want to sample these buses, set **Source Bus** to a REC bus.

In Sampling mode, you can mix several audio inputs to a REC bus for sampling, or you can mix the direct sound of audio inputs with the sound processed by insert effects and sample the combined result from the REC bus.

In other modes (e.g., Program mode), you can use the REC buses to sample just an audio input that’s playing along with a KARMA performance being output to the L/R bus.

Off: The external audio signal will not be sent to the REC buses. Normally you will use the Off setting.

1, 2, 3, 4: The external audio input signal will be sent to the specified REC bus. The **Pan** setting is ignored, and the signal is sent in monaural.

1/2, 3/4: The external audio input signal will be sent in stereo to the specified pair of REC buses. The **Pan** setting sends the signal in stereo to buses 1 and 2 or buses 3 and 4.

Send1 (to MFX1), Send2 (to MFX2)

These adjust the levels at which the external audio input signal is sent to the master effects.

Send1 (to MFX1): Send the signal to master effect 1.

Send2 (to MFX2): Send the signal to master effect 2.

If **Bus Select (IFX/Indiv.)** is set to IFX1–12, the send levels to the master effects are set by the post-IFX1–12 **Send1** and **Send2**.

PLAY/MUTE

This indicates whether the external audio signal being input is in PLAY or MUTE status.

You can use the MIX PLAY/MUTE 1–6 switches to change this.

SOLO On/Off

This indicates the SOLO status of each external audio signal input. You can use the MIX SELECT 1–6 switches to change this.

Sound will be output only from channels for which SOLO is On. Other channels will be muted. The solo function includes the oscillators of the tone generator.

Pan

This specifies the panning of the external audio input signal. When inputting a stereo audio source, you will normally set the inputs to L000 and R127 respectively.

Level

Specifies the level of the external audio signal that will be input. Normally you will set this at 127.

 The analog audio signals from the AUDIO INPUT 1–4 jacks are converted by an AD converter from analog to digital signals. This parameter sets the level of the signal immediately after it has been converted into digital form. If the sound is distorted

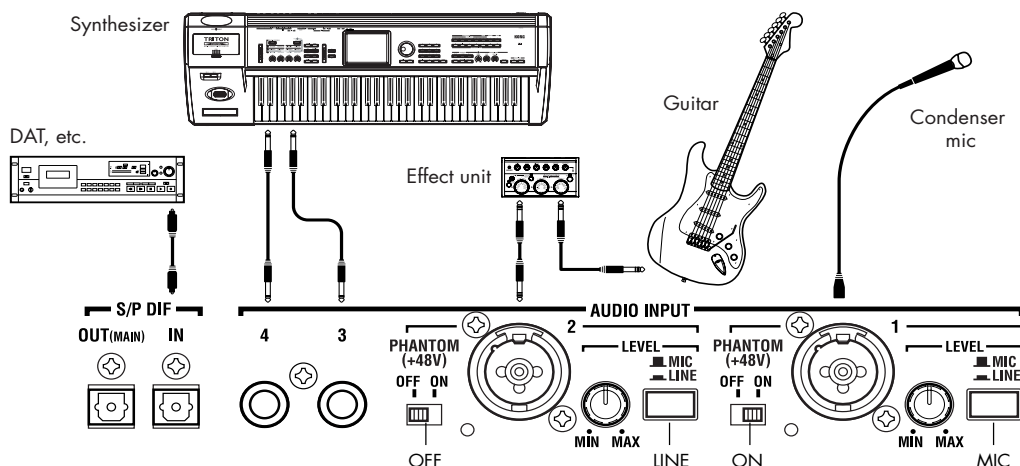

even though this level setting is very low, it is possible that the sound is distorting earlier than the AD converter. You'll need to adjust the MIC/LINE gain select switch, the LEVEL knob (AUDIO INPUT 1 and 2 only), or the output level of your external audio source.

⚡ If **Bus Select (IFX/Indiv.)** is other than Off, raising the **Level** will input the external input signal into the OASYS. If audio cables are connected to AUDIO INPUT 1–4 jacks at this time, any noise that may exist will be input via the AD converters into the OASYS even if no audio input signal is present, and may be output from AUDIO OUTPUT L/R and 1–8. If you're not using an external input, turn its **Bus Select (IFX/Indiv.)** off, or set its **Level** to 0. Similarly, if you're not using the S/P DIF IN jack, set its **Bus Select (IFX/Indiv.)** off, or set its **Level** to 0. **REC Bus** and **FX Control Bus** should also be turned off if you're not using them.

If you've set **REC Source** to Audio Input 1 or 2, the output of the AD converter is input directly into the OASYS without passing through **Bus Select (IFX/Indiv.)** or "Level." If the LEVEL setting of an audio input is set to a high gain, any existing noise component may be output from AUDIO OUTPUT L, R, and 1–8 even though no audio input is actually present. If you're not using an audio input, set its LEVEL setting to LINE, and turn the level down to the minimum.

The Input/Audio Input page in each mode

One set of Input/Audio Input settings are maintained by Sampling mode, and a different set of Input settings are shared by Combination, Program, and Sequencer mode. This latter set is saved as Global mode parameters.

Each combination, program, and song can also have its own Input/Audio Input settings. To enable this, turn "Use Global Setting" OFF in the respective pages listed below.

These settings can be made in the following pages:

Mode	Page
Sampling	P0: Recording– Audio Input
Combination	P0: Play– Audio Input/Sampling
Program	P0: Play– Audio Input/Sampling

Mode	Page
Sequencer	P0: Play/REC– Audio Input/Sampling
Global	P0: Basic Setup– Audio

Setting the recording level (Recording Level [dB])

Recording Level L, R Level Meter

This adjusts the signal level at the final stage of sampling. For the best-quality sampling, set the level as high as possible without allowing the level meter to indicate "CLIP !"

Press the SAMPLING REC switch to enter record-standby mode; the level meters will indicate the recording level of the signal from the bus line you selected in "Source Bus." You can use the slider to adjust the signal level. Start with the slider at 0.00, and adjust the level as high as possible without allowing the bar indicator to exceed 0 dB.

The power-on default setting is 0.0 dB.

Specifying the recording method (Recording Setup)

Source Bus

Here you can select the source that will be sampled. The signals of the buses you select here will be sampled.

L/R: The L/R bus following TFX1 and 2 will be sampled. The audio signals sent to the L/R bus and sounds played on the OASYS from the keyboard or via MIDI IN and sent to the L/R bus will be sampled. Normally you will use the L/R setting. (See the diagram below)

REC1/2, REC3/4: The REC1/2 or REC3/4 buses will be sampled. Use the REC buses when you want to play the keyboard or play back an audio CD while sampling only the audio input. You can also mix several audio input sources to the REC buses, or mix the direct sound of an audio input with sound processed by an insert effect and mix them to the REC buses for sampling.

If you choose REC1/2, REC bus 1 is input to the L

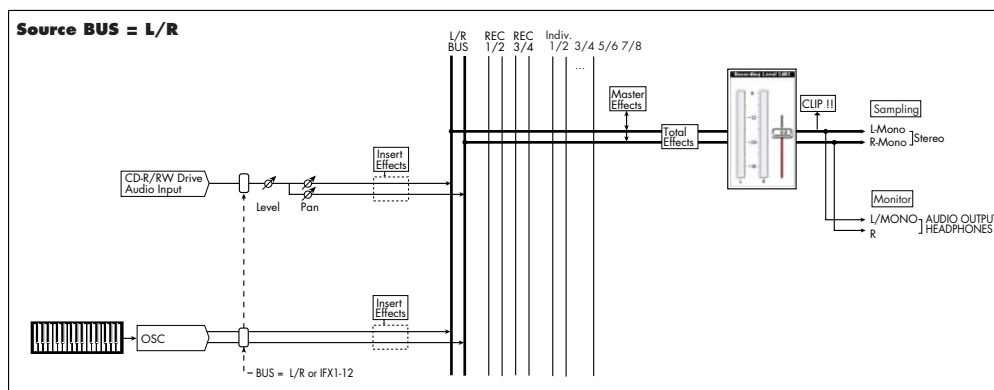

For a signal flow chart of other source buses, refer to PG p.397.

channel and REC bus 2 is input to the R channel. If you choose REC3/4, REC bus 3 is input to the L channel and REC bus 4 is input to the R channel.

Audio Input 1/2, Audio Input 3/4, S/P DIF L/R:

Choose these settings if you want to directly sample the input from AUDIO INPUT 1–4 or S/P DIF jacks. The input will be sampled directly without being routed through the L/R bus, REC buses, or Individual buses. AUDIO INPUT 1/2 or 3/4 and S/P DIF L/R will be connected directly, regardless of the “Audio Input” settings for “Bus Select (IFX/Indiv),” “Bus (IFX/Indiv),” **Pan**, and “Level.”

If you choose Audio Input 1/2, AUDIO INPUT 1 is input to the L channel and AUDIO INPUT 2 is input to the R channel. If you choose Audio Input 3/4, AUDIO INPUT 3 is input to the L channel and AUDIO INPUT 4 is input to the R channel.

Indiv.1/2, Indiv.3/4, Indiv.5/6, Indiv.7/8: The Indiv.1/2–Indiv.7/8 buses will be sampled. Choose these settings if you want to sample only the audio inputs while monitoring the L/R outputs, similarly to when using the REC buses.

If you choose Indiv.1/2, Indiv. bus 1 is input to the L channel and Indiv. bus 2 is input to the R channel. Similarly for Indiv.3/4, 5/6, or 7/8, the buses are input to the L and R channels respectively.

Source Direct Solo

If this is unchecked, the L/R (post-TFX) signal and the signal of the bus line specified for **Source Bus** will be output from the L/R jacks and the headphone jack according to the Audio Input **Bus Select (IFX/Indiv.)** setting and the post-IFX **Bus Sel.** setting.

Normally you will leave this unchecked, so that **Source Bus** and “L/R” are both heard. Check this if you want to monitor only the sound that’s being recorded. Only the signal of the bus line selected for **Source Bus** will be output from the L/R jacks and the headphone jack.

Note: If **Source Bus** is L/R, this setting is ignored, and the L/R (post-TFX) signal will always be output from the L/R jacks and headphone jacks.

Trigger

Specifies how sampling will be initiated.

The triggers you can select will differ depending on the mode.

Sampling mode:

Sampling START SW, Note On, Threshold

Program, Combination mode:

Sampling START SW, Note On

Sequencer mode:

Sampling START SW, Note On, Threshold, Sequencer START SW

Here we will explain the Sampling START SW and Note On trigger methods which are available in all modes. For the trigger mode that’s most appropriate in various situations, refer to the various examples of sampling.

Sampling START SW: When you press the SAMPLING REC, you will enter sampling-standby mode; sampling will begin when you press the SAMPLING START/STOP switch.

Note On: Press the SAMPLING REC switch and then press the SAMPLING START/STOP switch to enter sampling-standby mode. Sampling will begin when you play the keyboard.

Making settings for the sample to be recorded (REC Sample Setup/Sampling Setup)

Next we will specify the location into which the data will be sampled, select mono or stereo sampling, and specify the sampling time.

In Sampling mode, these settings are made in REC Sample Setup. In Combination, Program, and Sequencer modes, these settings are made in Sampling Setup. These settings apply only in each respective mode.

The Recording Setup page in each mode

Mode	Page
Sampling	Sampling P0– Recording
Combination	Combination P0– Audio Input/Sampling
Program	Program P0– Audio Input/Sampling
Sequencer	Sequencer P0– Audio Input/Sampling

Sampling mode

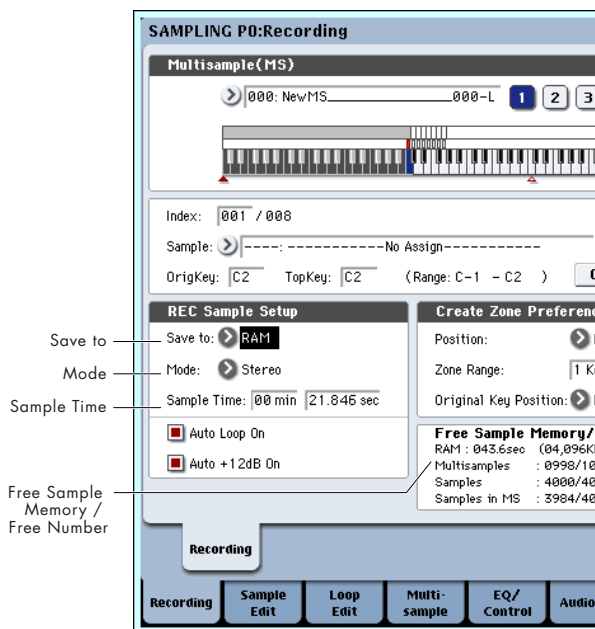

Program mode

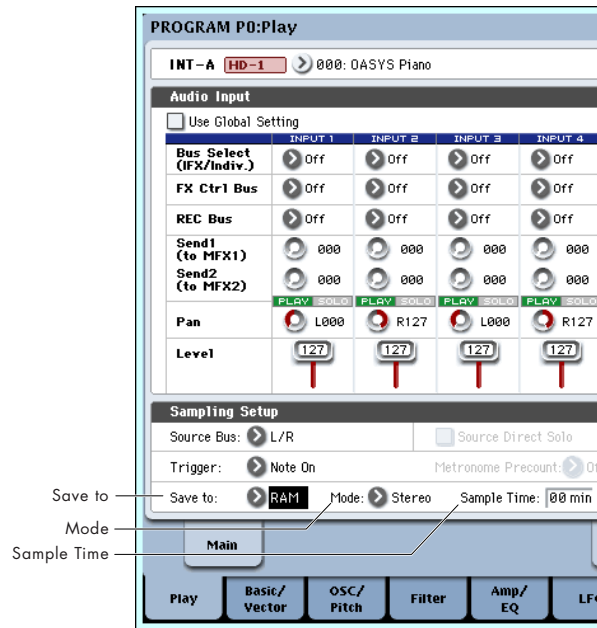

Save to

Specifies the destination to which the data will be written during sampling.

RAM: The sample will be written to RAM memory. A sample written into RAM memory can be heard immediately in Sampling mode.

DISK: The sample will be written to the hard disk.

If you've selected DISK, you can also select the writing-destination drive.

In each mode, use the "Select Directory" page menu command to select the drive.

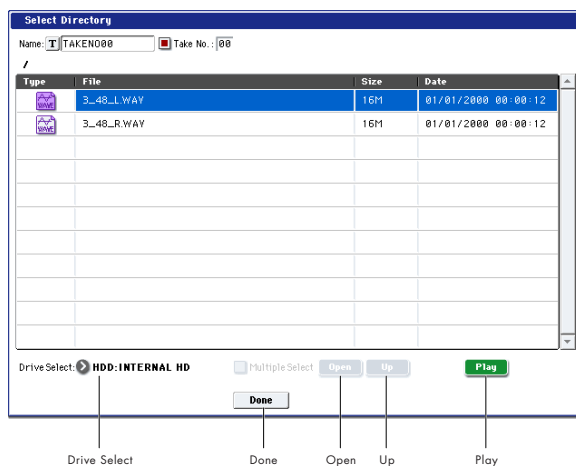

Use "Drive Select" to select the desired drive, and use the Open or Up buttons to move to the desired level. You can press the Play button to play back a selected WAVE file. Press the Done button to confirm the settings you've made.

Mode

Specifies the channel(s) that you want to sample, and specify whether a mono or stereo sample will be created.

The L and R channels of the bus specified by **Source Bus** will be sampled.

L-Mono: The L channel of the bus specified by **Source Bus** will be sampled in mono.

R-Mono: The R channel of the bus specified by **Source Bus** will be sampled in mono.

Stereo: The L and R channels of the bus specified by **Source Bus** will be sampled in stereo. This will create a stereo multisample and samples.

Sample Time

Specifies the amount of time that you wish to sample. This can be set in 0.001 second increments. If you record a sample in this condition ([REC]→[START]→[STOP]), the change in time will be displayed automatically.

If the writing-destination ("Save to") is DISK, the maximum value is calculated from the amount of remaining space on the disk specified by "Select Directory." You can't sample for longer than 80 minutes.

Recording Level and Auto +12 dB On

When you resample an external audio source, the song playback, or your keyboard performance on a program, combination, or sample, you will normally set the **Recording Level** at 0 (dB). If this is set at 0 (dB), the sample data will be recorded at the optimal level. However when this data is played back, the OASYS will play it back at a lower level than when it was sampled (if +12 dB is off). If you want to play back the data at the same level at which it was sampled, you'll need to turn the +12 dB parameter on (Sampling P2-Loop Edit page).

If you sample with the **Auto +12 dB On** setting checked, +12 dB will automatically be turned on, and the recorded sample will play back at the same level at which it was sampled.

Optimizing the RAM memory

If RAM has been specified as the destination to which data will be written during sampling, you can specify that RAM memory be automatically optimized after the data is written. When optimization is performed, unused areas that are occupying memory space will be reorganized to increase the available free space. In the Global mode P0: Basic Setup- Basic page, you can check "Auto Optimize RAM" so that RAM will automatically be optimized when sampling ends. In this case, you will always be able to sample without any wasted RAM area, but the sound will stop for a time when sampling ends. If a song is being played back in Sequencer mode, the playback will stop.

If you are playing back a song, or if you are repeatedly recording multiple samples in various locations while listening to audio input from a CD etc., you can sample with "Auto Optimize RAM" unchecked, and then execute the page menu command "Optimize RAM" (found in the Sampling page of Program, Combination, or Sequencer modes, and in P0-P4 of Sampling mode) to optimize the RAM when the remaining amount of memory begins to decrease. You can check on the remaining amount of memory in Sampling mode on the P0: Recording page, under Free Sample Memory/Locations. For more information, see "0-1f: Free Sample Memory/Locations" on page 572 of the Parameter Guide.

Using the metronome

It is convenient to use the metronome when you want to play a program or combination at a specific tempo and sample your performance.

You can make metronome settings in **Metronome Setup**, in Program or Combination P0: Play– Audio Input/Sampling. You might find it convenient to set “Bus (OUTPUT) Select” to one of the Indiv. 1–8 outputs, connect the (INDIVIDUAL) 1–8 jacks to a mixer, and monitor the metronome via your mixer.

Automatically setting-up for the desired sampling method (Auto Sampling Setup)

In each mode, Auto Sampling Setup automatically makes the appropriate settings for the sampling-related parameters. For example in Program mode you

can use this to make the necessary settings for resampling your playing on a program, or to make settings for sampling only an external audio source while you monitor your playing on a program. However, these automatic settings assume typical situations, so you’ll need to adjust the parameters to meet your situation.

This function is available in the following pages:

Mode	Page
Sampling	Sampling P0: Recording
Combination	Combination P0: Play– Audio Input/Sampling
Program	Program P0: Play– Audio Input/Sampling
Sequencer	Sequencer P0: Play/REC– Preference, Audio Input/Sampling

Sampling and editing in Sampling mode

In Sampling mode, you can record samples, and edit sample data that you sampled or loaded from media (including WAVE and AIFF formats). You can also assign the edited samples to indexes (zones) to create a multisample.

Sampling mode page structure

Page	Explanation
P0: Recording	<ul style="list-style-type: none"> • Sampling and resampling • Various settings for sampling • Audio input settings • Edit using the control surface
P1: Sample Edit	<ul style="list-style-type: none"> • Sample waveform editing
P2: Loop Edit	<ul style="list-style-type: none"> • Sample playback parameter settings • Start, loop start, and end address settings • Loop and reverse playback on/off • Editing operations such as Time Slice and Time Stretch
P3: Multisample Edit	<ul style="list-style-type: none"> • Assign samples to multisamples, and specify the zone and original key
P4: EQ/Controller	<ul style="list-style-type: none"> • EQ adjustments for multisample playback • Assign functions to controllers
P5: Audio CD	<ul style="list-style-type: none"> • Play back audio CDs • Rip audio CDs
P6:	–
P7:	–
P8: Insert Effect	<ul style="list-style-type: none"> • Select and edit insert effects, adjust send levels to the master effects, and specify the routing to the outputs
P9: Master, Total Effects	<ul style="list-style-type: none"> • Select and edit master send effects and total effects

For details on how to access each mode and page, refer to “Basic operations” on page 34.

Sampling can be performed in any page P0–P9 of Sampling mode by using the REC/WRITE switch and the START/STOP switch. Recording-related settings such as input level are made by the parameters of P0: Recording, and these settings are valid for the other pages as well.

The selected multisample or sample can be played from the keyboard in any page, allowing you to hear the results of your editing in each page.

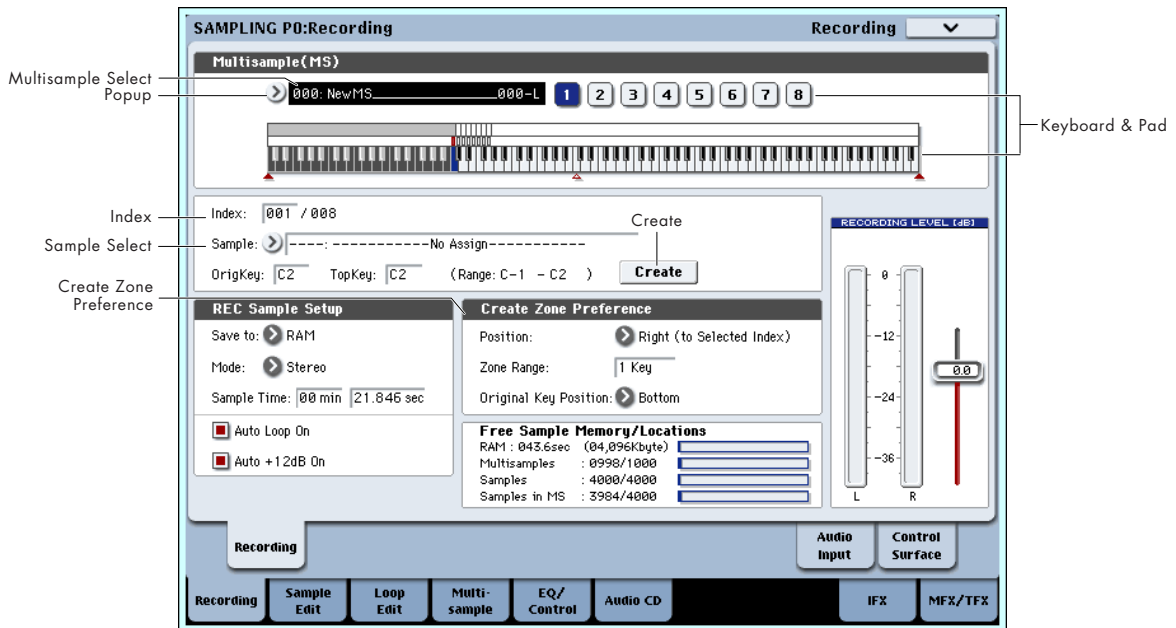

Creating multisample indexes and sampling – P0: Recording

Here's how to create indexes in a multisample, and assign a sample to each index.

1. Press the MODE SAMPLING switch to enter Sampling mode.
2. Select the P0: Recording– Recording page.
3. Select "Multisample Select," and create a multisample.

To create a new multisample, press the "Multisample Select" popup button. Then press a Multisample No. in the list for which no name has been entered, or use the numeric keys 0–9 to input a number and then press the ENTER switch.

A dialog box will appear.



If you want to create a stereo multisample, check the "Stereo" box, and press the OK button.

If you want to create a monaural multisample, uncheck the "Stereo" box, and press the OK button.

4. Press the Create button to create an index.

Immediately after the power is turned on, "Index" will be 001/008. This indicates that there are eight indexes, and that the first index is selected (see the illustration below).

Press the Create button several times. Each time you press it, an index will be created. The keyboard display will indicate the zone and original key location of each index.

Note: The index that is created when you press the Create button will be created according to the P0: Recording– Recording page Create Zone Preference settings. (These settings can also be made in P3: Multisample Edit page, Create Zone Preference)

Immediately after the power is turned on, "Position" will be Right (to selected index), "Zone Range" will be 1 Keys, and "Original Key Position" will be Bottom, so that indexes will be created as shown below. This is convenient when you want to sample multiple takes of a phrase or rhythm loop in a single operation.



If you set "Zone Range" to 12 Keys, indexes will be created at intervals of one octave.

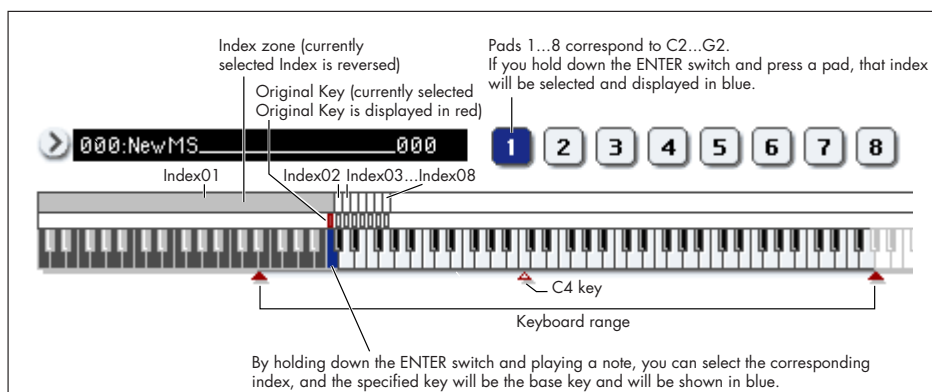
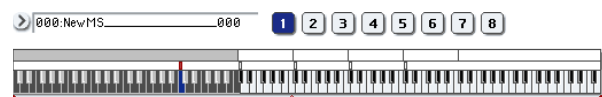

5. Select “Index.”

You can also select “Index” by holding down the ENTER switch and playing a pad or a note on the keyboard. For this example, select 001.

6. Assign a sample to the “Index.”

If RAM memory already contains samples, use “Sample Select” to select the sample and assign it.

If you want to record a new sample, you can sample it now.

The sample you record will be automatically assigned to the index you selected in step 4.

The assigned sample will sound when you play the keyboard in the range of the index to which the sample is assigned.

7. Repeat steps 5 and 6 to assign a sample to each index.

The number and order of the indexes in a multisample, the range of each index, and the original key position can be freely changed later if desired. (See “Multisample editing” on p.138)

Creating multiple samples

In the example procedure described above, several indexes were created (by pressing the Create button several times), and then samples were assigned to each “Index.”

As an alternative method, it is also possible to create one index, sample into it, and then repeat these two steps.

1. Press the Create button once to create an index.
2. Record a sample.

The recorded sample will automatically be assigned to the index you created in step 1.

3. Repeat steps 1 and 2.

This is an efficient way to record multiple samples.

Assigning samples to the pads

By default, pads 1–8 correspond to the C2–G2 keys.

For example, the default “Index” setting for 001/008 sets “OrigKey” and “Top Key” to C2. The assigned sample will sound when you play the C2 key. The same sample will also sound when you strike pad 1. Similarly, if you assign samples to “Index” 002–008, the samples that sound when you play the C#2–G2 keys will also sound when you strike pads 2–8.

If you press the PAD MODE switch to make VELOCITY SENSITIVE light, you will be able to change the volume by adjusting the force with which you strike the pads. If you make FIXED VELOCITY light, the volume will be according to the velocity values specified in the Sampling P4: EQ/Controller–Pads Setup page.

For each pad, you can change the note numbers used to play samples.

These settings are made in the Sampling P4: EQ/Controller–Pads Setup page. For example, you might assign the infrequently-played highest eight notes of the 76-note keyboard (C7–G7) to correspond to the pads. To make the setting, select the note number field, and play the desired key while holding down the ENTER switch.

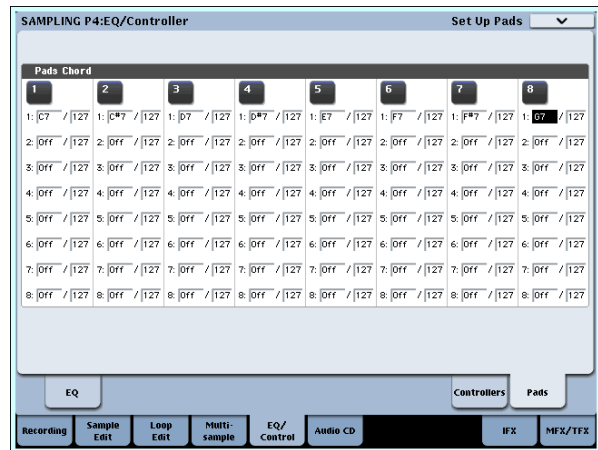

Basic examples of sampling

Sampling your voice from a mic, and playing it back as a one-shot sample

In this example we will use a mic connected to the AUDIO INPUT 1 jack to sample your voice in monaural.

Connect a mic

1. Connect a mic to the rear panel AUDIO INPUT 1 jack.

Press the AUDIO INPUT MIC/LINE switch so that it’s in the MIC (outward) position, and set the LEVEL knob near the center. If you’re using a phantom-powered condenser mic, turn the PHANTOM switch on. (See “Audio input settings” on page 121)

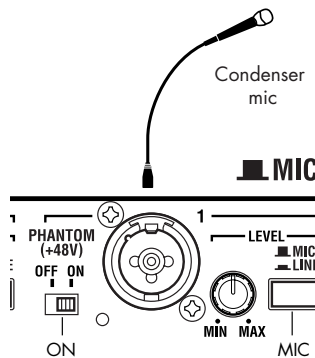

2. Access the Sampling P0: Recording– Audio Input page.

Press the MODE SAMPLING switch to enter Sampling mode. Make sure that the Sampling P0: Recording page is displayed.

If it is not, press the EXIT switch, and then press the Audio Input tab.

3. In the P0: Recording– Audio Input page, make the following settings.

– INPUT1 –

Bus Select (IFX/Indiv.) L/R

Pan: L000

Level: 127

This specifies the input level and pan of the INPUT 1 jack, and assigns L/R bus as the destination.

– Sampling Setup –

Source Bus: L/R

The sound being sent to the L/R bus will be sampled.

Trigger: Threshold

With this setting, sampling will start when the input exceeds a specific volume.

Threshold Level: -30 dB

From the record-ready state, recording will start automatically when the audio input exceeds -30 dB.

Pre Trigger REC: 005ms

Recording will begin immediately (5 ms) before sampling is started, so that the attack of the sound is not lost.

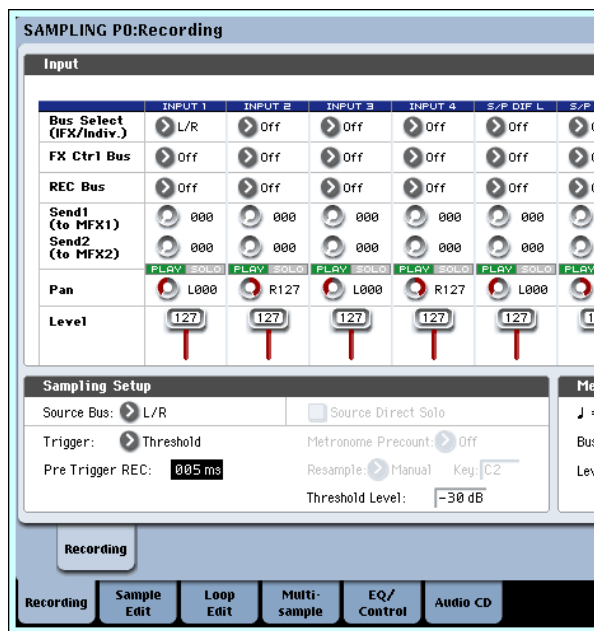

4. Press the Recording tab to access the P0: Recording– Recording page. Make the following settings.

– REC Sample Setup –

Save to: RAM

You will be sampling to RAM memory.

Mode: L-Mono

The sound of the internal L channel will be sampled in mono.

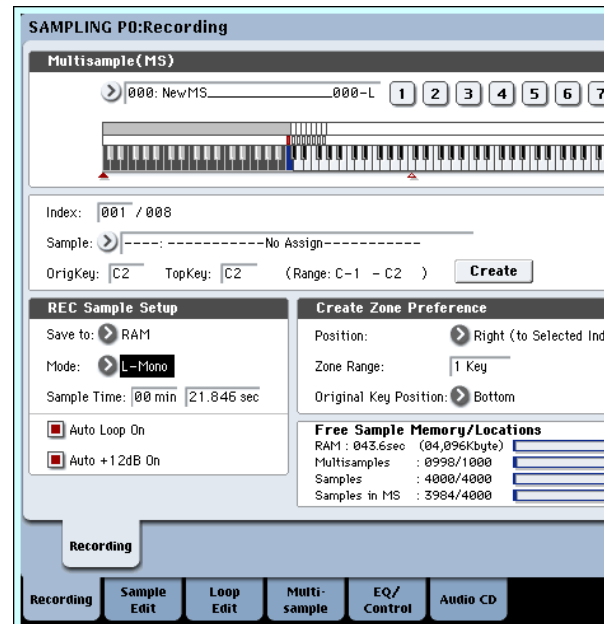

Set the recording level

5. Speak or sing at the volume you intend to record.

If the “ADC OVERLOAD !” (AD converter input overload) indication appears, turn the rear panel LEVEL knob toward MIN to adjust the level appropriately.

For the best sound, adjust the level as high as possible without allowing the “ADC OVERLOAD !” indication to appear.

6. Press the SAMPLING REC switch.

Speak into the mic, and notice that the level meter indicates the volume of the sound that will be recorded.

If the “CLIP!” indication appears, use the VALUE controller to lower the Recording Level slider (shown in the right of the display) from the +0.0 setting to an appropriate position.

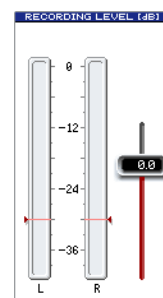

7. When you’ve finished making adjustments, press the SAMPLING REC switch.

Record

8. Press the SAMPLING REC switch.

The OASYS will be in record-ready mode.

9. Speak into the mic, saying the word(s) you want to sample.

(Example: “It’s”)

Recording will start when the level exceeds the Level -30 dB setting.

10. When you've finished saying the word(s), press the SAMPLING START/STOP switch.

This completes the sampling operation. The new sample will be automatically assigned to "Sample (Sample Select)."

Hear the sampled result

11. The sample you just recorded will (by default) be assigned to Index 001. When you press the "OrigKey" key (C2) for Index 001, you will hear the sound you just sampled.

You can also strike pad 1 to hear this sound.

Notice that the sample will loop (play repeatedly) if you hold down the key or pad. We're going to turn looping off.

Turn looping off

12. Press the Loop Edit tab to access the P2: Loop Edit page.

Uncheck "Loop." Now the sample will not loop even if you hold down the C2 key.

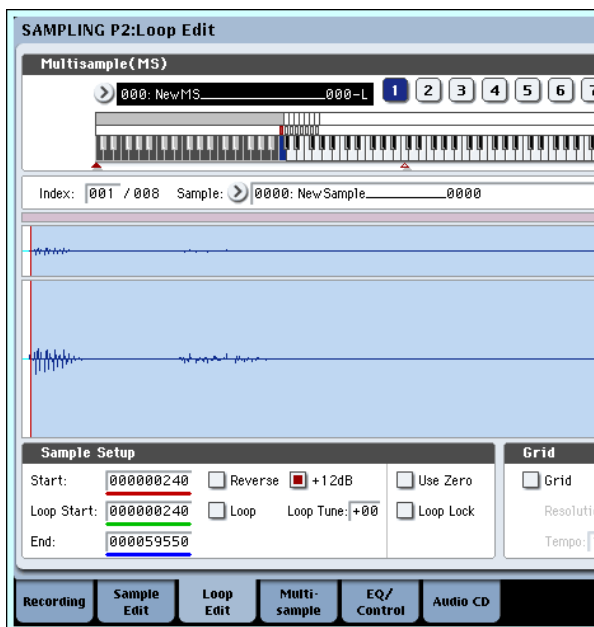

13. Now we'll specify that looping will be turned off for each newly recorded sample.

Press the lower Recording tab and then the upper Recording tab to access the P0: Recording-Recording page.

Uncheck "Auto Loop On."

If "Auto Loop On" is checked, the "Loop" setting will automatically be turned on when you sample, so that the sample will loop.

Record the next sample

14. In the P0: Recording, Recording page, select "Index" and press the Δ switch to select 002.

15. Press the SAMPLING REC switch and then the SAMPLING START/STOP switch.

Speak into the mic, saying the word(s) you want to sample.

(Example: "So")

When you've finished speaking, press the SAMPLING START/STOP switch.

16. Repeat steps 14 and 15 several times more to record a few more samples.

(Example: "Easy," "To," "Sample," "With," "OASYS")

Listen to the recorded result

17. Play the keys one after another.

Play the keys starting at C2 in semitone steps. The samples you just recorded will play one after another.

(For example if you sequentially play the keys from C2 through F#2, you will hear "It's So Easy To Sample With OASYS.")

The multisample you created can be used as a program or combination. (See "Converting a multisample to a program" on page 140)

Sampling external audio through insert effects

In this example, we'll apply an insert effect to the sound from a mic connected to the AUDIO INPUT 1 jack, and sample the processed sound in stereo.

Connect a mic

1. Connect your mic to the rear panel AUDIO INPUT 1 jack. (See "Sampling your voice from a mic, and playing it back as a one-shot sample" on page 128)

Setup

2. In the P0: Recording- Audio Input page, make the following settings.

- INPUT1 -

Bus Select (IFX/Indiv.): IFX1

Pan: C064

Level: 127

This specifies the input level and pan of the INPUT 1 jack, and assigns IFX1 bus as the destination.

- Sampling Setup -

Source Bus: L/R

Trigger: Threshold

Threshold Level: -30 dB

Pre Trigger REC: 005ms

For details on Recording Setup, refer to step 3 of "Sampling your voice from a mic, ..."

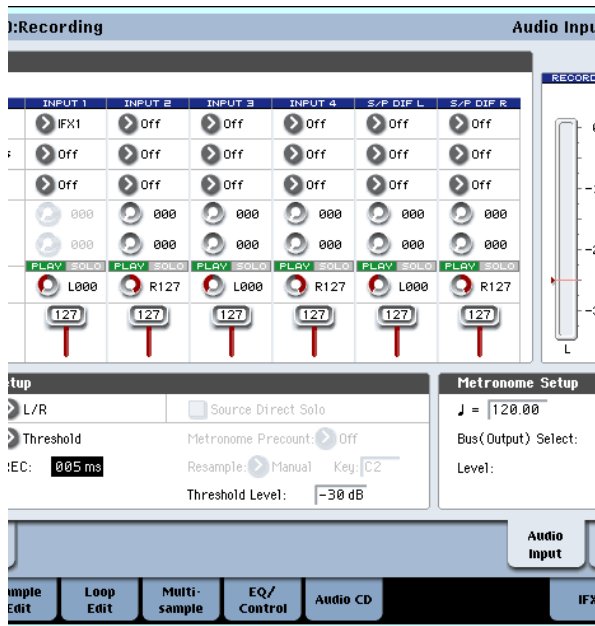

3. Access the P8: Insert Effect– Insert FX page.
Press the IFX tab, and then the Insert FX tab.
4. Select IFX1, use the numeric keys to input 1, 0, 1, and press the ENTER switch to select 101: Reverb Hall.
Press IFX1 On/Off to turn it on.

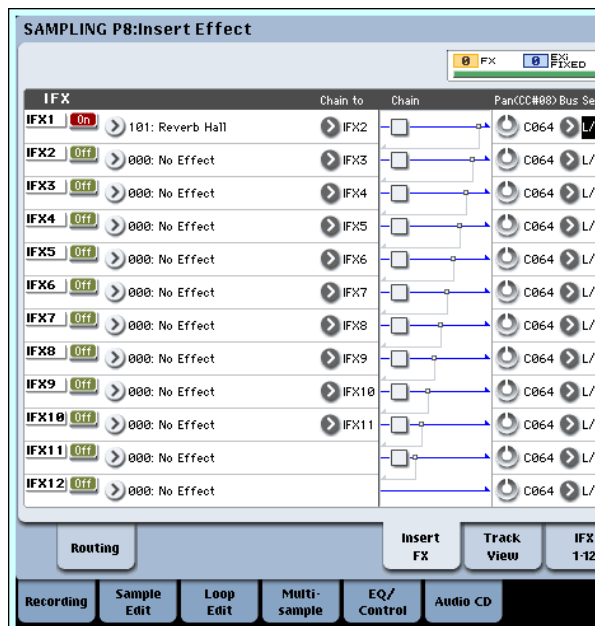

5. Speak into the mic, and verify that reverb is applied.
You can use the IFX1 page (IFX1 tab) to edit the effect settings.
6. Make sure that the Bus Sel. that follows IFX1 is set to L/R.
7. Press the EXIT switch, and then press the Recording tab to access the P0: Recording–Recording page.
8. Set the REC Sample Setup Mode to Stereo.
With this setting, the sound of the internal L/R channels can be sampled in stereo.

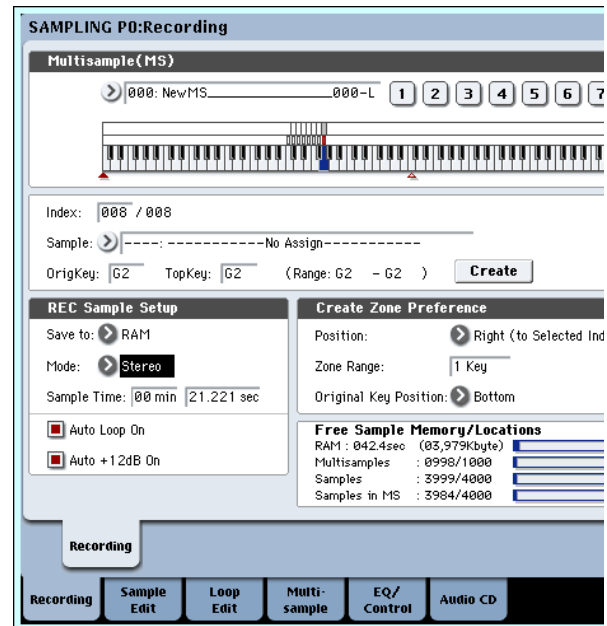

9. Select Index.
If you want to create a new index, press the Create button.
10. Sample the sound.
Press the SAMPLING REC switch, and then the SAMPLING START/STOP switch to enter record-ready mode.
Speak the word you want to sample.
Recording will start when the level exceeds the Level -30 dB setting.
Press the SAMPLING START/STOP switch to stop sampling.
11. Play the keyboard.
Press the "OrigKey" key to hear the sound you sampled.

Sampling from the S/P DIF input

In general, sampling from the S/P DIF inputs is very similar to sampling from the analog inputs. For instance, to record a stereo sample from the S/P DIF inputs, set up the sampling parameters as below:

Source Bus: S/P DIF L/R

Resample: Manual

Recording Level [dB]: as desired

Mode: Stereo

Important: Whenever using the digital inputs and outputs, make sure that the Global System Clock parameter is set correctly. For more information, see "System Clock" on page 644 of the Parameter Guide.

Applying an insert effect to a sample and resampling the result

The process of applying an insert effect etc. to a sampled sound and then sampling it once again is called "resampling."

1. In the P0: Recording– Recording page, assign the sample that you want to resample to Sample Select.

When the power is first turned on, the assigned sample will be set to “Orig.Key C2.”

2. Make the following settings.

– INPUT1 –

Bus Select (IFX/Indiv.): Off

Turn off the input from the INPUT 1–4 and S/P DIF L/R jacks.

– Sampling Setup –

Source Bus: L/R

The sound sent to the L/R will be sampled.

Trigger: Sampling START SW

After you’ve pressed the **SAMPLING REC** switch to enter sampling-ready mode, resampling will begin when you press the **SAMPLING START/STOP** switch.

Resample: Auto

The sample assigned to the index will be resampled automatically.

Key: C2

Use **Key** to specify the sample that will be resampled.

Recording Level: 0.0

This is the default setting for resampling.

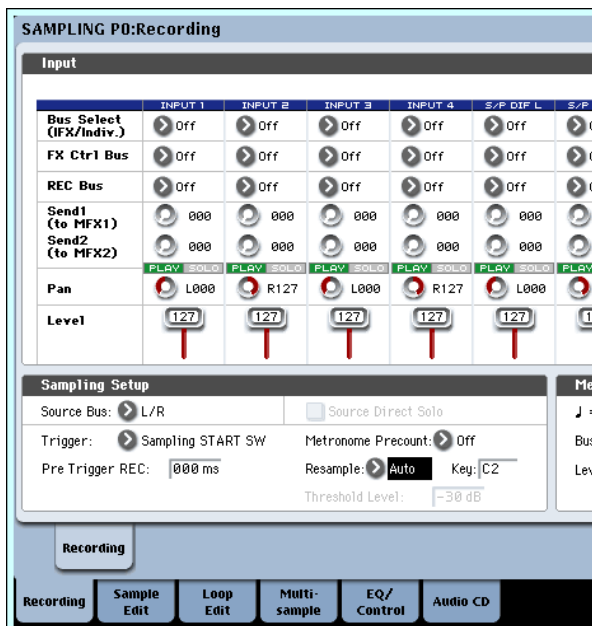

Save to: RAM

The data will be written to RAM memory.

Sampling Mode: Stereo

The sound of the internal L/R channels will be sampled in stereo.

Auto +12dB On: On

The +12 dB setting will automatically be turned on for the samples you record.

⚠ Be aware that if you change the Bus setting from Off to L/R or IFX1–12, the volume level sent to the AUDIO OUT L/MONO and R jacks and the headphones may rise excessively.

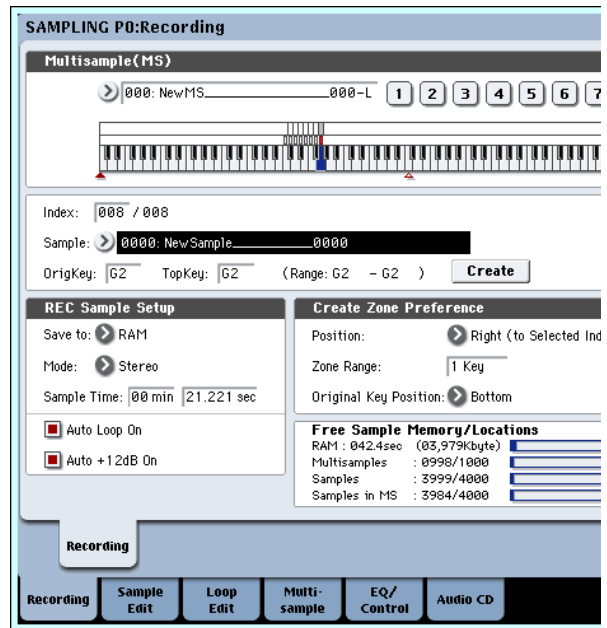

3. In P2: Loop Edit, check the +12 dB setting.

4. In the P8: Insert Effect– Routing page, set Bus Select to IFX1.

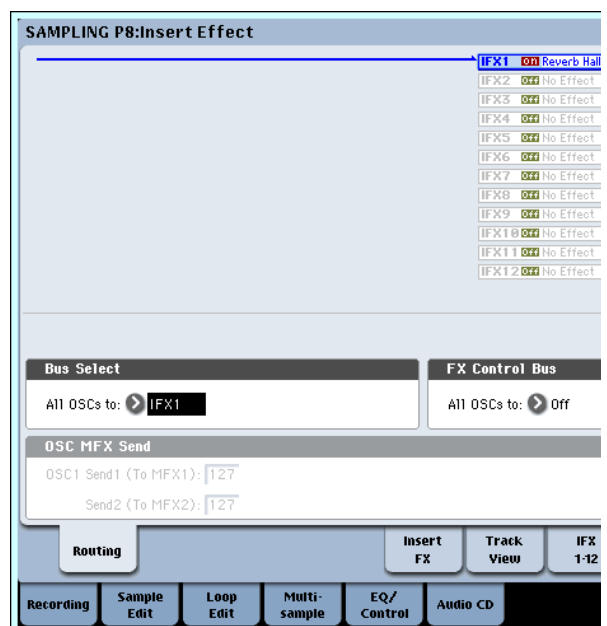

5. In the P8: Insert Effect, Insert FX page, set IFX1 to 101: Reverb Hall, and turn IFX On/Off ON.

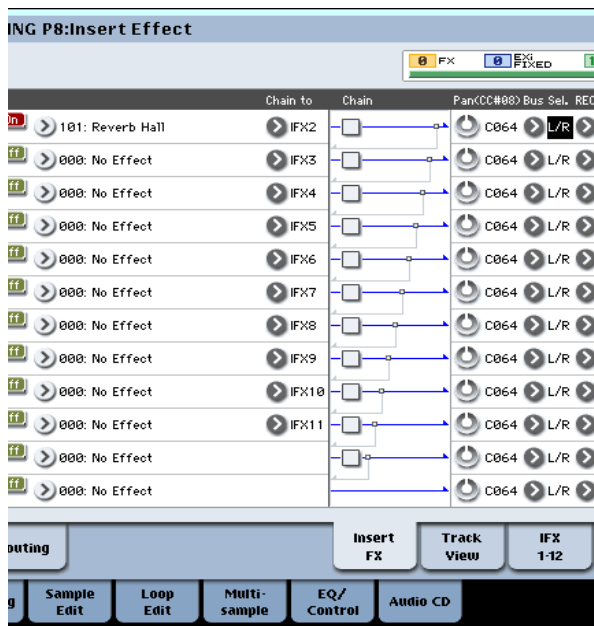

Press the C2 key, and verify that reverb is applied.

Also make sure that the **Bus Sel.** following IFX1 is set to L/R.

6. Press the SAMPLING REC switch, and then the SAMPLING START/STOP switch.

The sample assigned to C2 will play automatically, and resampling will begin.

When the sample finishes playing, resampling will end.

The sample that was created by resampling will automatically be assigned to **Sample Select**.

Note: In Sampling mode, the P8– Routing page **Bus Select** parameter will automatically be set to L/R when resampling ends. This prevents an insert effect from being applied in duplicate when you monitor the results of resampling through an insert effect.

If you want to apply an insert effect once again, re-select IFX1.

Note: As an alternative to automatically resampling as described above (**Resample Auto**), you can simply sample the sounds that you play from the keyboard (**Resample Manual**).

In **Sample Select**, assign the sample that you will resample, and set **Resample** to Manual. Set **Trigger** to Note On, and set **Sample Mode** to Stereo as desired. Then set the bus and effect as described in steps 2 and 7, press the **SAMPLING REC** and then the **START/STOP** switch, and then press the C2 key to start resampling. When you want to stop resampling, press the **SAMPLING START/STOP** switch.

Loop Edit – P2: Loop Edit

You can edit the playback address at which the sample will be looped. The P2: Loop Edit page lets you do the following things.

- You can specify the looping addresses by editing “Start,” “End,” and “Loop Start” while watching

the waveform. Functions like Zoom In/Out, Use Zero, and Grid make editing easy.

- You can turn looping on/off, adjust the tuning of the loop playback, apply a +12 dB playback boost, or reverse the playback.
- You can use the Time Slice function to automatically detect the attacks of kick and snare notes etc. in a rhythm loop sample (a looped sample containing a drum pattern), and automatically slice the sample at the appropriate locations. This function can automatically create performance data (notes) to play the divided samples at the appropriate moments, letting you play this phrase in Sequencer mode at the desired tempo without affecting the pitch of the individual notes. You can also do things like changing the pitch of just the snare drum, replacing it with an entirely different sample, or changing the playback timing of the phrase in the sequencer to transform the original rhythm loop into an entirely different rhythm loop. (Stereo samples are supported.)
- You can use the Time Stretch function to modify the tempo without changing the sample’s pitch. When executing Time Stretch, you can choose either “Sustaining” (suitable for loops of sustained sounds such as strings or vocal) or “Slice” (suitable for loops of decay-type sounds such as drums). (Stereo samples are supported.)
- Sometimes when looping a sample of pitched instruments such as strings or winds, the looped portion may play back in an unnatural way. By executing the Crossfade Loop function you can eliminate this problem so that the loop sounds right.

Loop settings

1. Select the sample for which you wish to make loop settings.

To select the sample, use the “Sample Select” or “Index” parameters of P2: Loop Edit page or of the P0: Recording, Recording page.

- ⚠ If you use “Sample Select” to select the sample, be aware that the assignment to the index will also change.

2. In the P2: Loop Edit page, use the “Loop” check box to turn loop playback on/off for the sample.

Looping will be turned on if the box is checked.

This will operate between the addresses you specify in step 3.

Loop On: Start→End→Loop Start→End→ (Loop Start→End is repeated)

Loop Off: Start→End

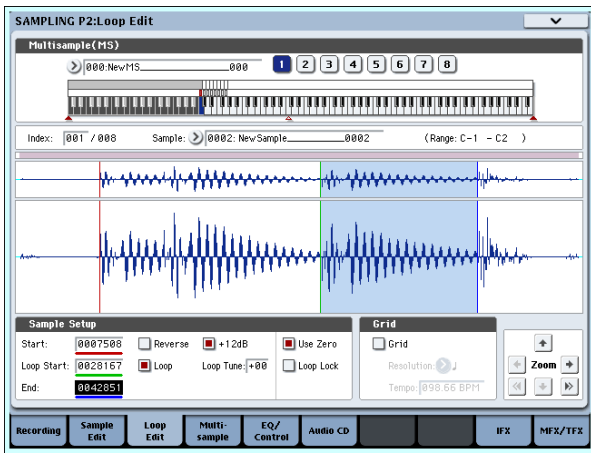

To play the sample, press the key to which the sample is assigned (the key range that is highlighted in "Keyboard & Pad").

A sample waveform that was sampled with "Sample Mode" set to Stereo will be displayed in two levels. The upper level is the L channel, and the lower level is the R channel.

3. Specify the start address in "Start," the loop start address in "Loop Start," and the end address in "End."

Select "Start" (highlighted), and use the [VALUE] dial or other VALUE controllers to modify the value. The corresponding vertical line will move. Set "Loop Start" and "End" in the same way. In the example shown below, "Start" is set immediately before the first waveform, "LoopS (Loop Start)" is set immediately before the second waveform, and "End" is set as desired.

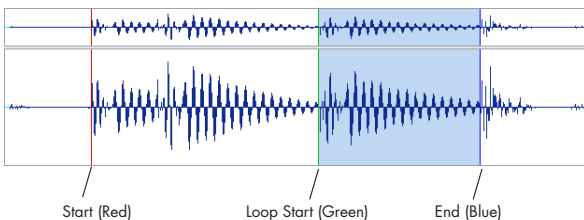

ZOOM

4. By using the ZOOM button you can change the range that is displayed. When "Start" is highlighted, zoom will be performed from the start address.

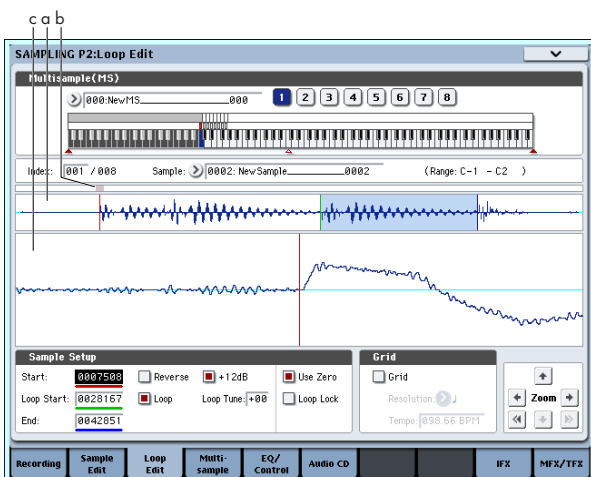

Area "a" shown in the illustration displays the entire sample. Area "b" indicates the region within the entire sample that is shown in area "c." As you zoom-in on the time axis, this shows you where the zoomed region is located within the entire sample. Use the Zoom buttons to specify how area "c" will show a magnified (zoom-in) or reduced (zoom-out) view of the waveform.

Use Zero

If the "Use Zero" check box is checked, only those addresses where the waveform data crosses the zero level will be found automatically when searching, and can be set. This lets you easily make address settings where noise is less likely to occur when looping.

Truncate

5. If necessary, use the page menu command "Truncate" to delete unwanted data that falls outside the start (or loop start) and end addresses. Select the Front & End radio button.

In this example, we will not change the settings of the "Save to No." and "Overwrite" check boxes, so press the OK button to execute.

When you execute this operation, the truncated sample data will automatically be assigned to the index.

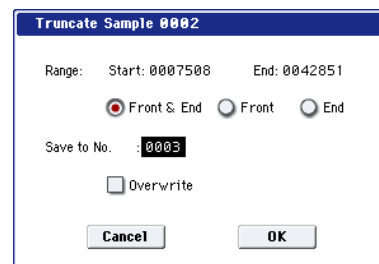

- ⚠ In the dialog boxes of some page menu, there is a "Save to No." setting that lets you specify the sample number to which the edited sample will be saved. At this time, a vacant sample number will be selected automatically, so you will change the setting only if you want to specify the save destination number. If you check "Overwrite" in the dialog box of the command, the data prior to editing will be deleted, and will be overwritten by the edited data. Normally, you will execute the Write operation without checking this, so that the unedited data is preserved. When you are completely finished with your editing, you can use the page menu command "Delete Sample" to delete unneeded samples.

Using the grid to make loop settings

"Grid" overlays a grid on the waveform display to indicate the tempo BPM. This helps you make loop settings that match the tempo.

You can also view the grid in the P1: Sample Edit page, and use the grid to edit the waveform to match the tempo.

1. Check "Grid."

The grid will appear in the waveform display.

Set "Resolution" as desired, and specify the tempo BPM value.

The grid is displayed according to the playback pitch at the base key (the key shown in blue for "Keyboard & Pad"). You can select the base key by holding down the ENTER switch and playing a key.

Press the base key to play the sample, and press the TAP TEMPO switch at quarter-note intervals along with the phrase. This will enable Tap Tempo and specify the tempo.

2. Set the end address "End" so that it coincides with a grid line.

This will make the loop length match the BPM.

If looping is on, the grid is displayed beginning at "Loop Start." If looping is off, the grid is displayed beginning at "Start."

3. If you want to hide the grid display, uncheck the "Grid" option.

Using Time Slice to divide a sample, and playing it in Sequencer mode

Time Slice is a function that detects the attack of the kick or snare etc. in a rhythm loop sample (a sample consisting of a looped pattern of drums etc.), and automatically divides it into separate instrumental sounds. Each of the divided instrumental sounds is made into a sample of its own, and then automatically expanded into a multisample and program. Pattern playback data for the Sequencer mode using the divided samples is also created automatically.

The time-slices sample can be used in the following ways by the song of Sequencer mode.

- Multiple rhythm loop samples of differing tempo can be matched to the same tempo without changing their pitch.
- You can change the tempo in realtime without affecting the pitch.

As an example, we will describe how a rhythm loop sample can be time-sliced in Sampling mode, and then how the rhythm loop sample can be played in Sequencer mode.

You will need to provide rhythm loop samples of drums etc. You can either record these on the OASYS, or load them in Disk mode. Initially, you should try this using a one-measure pattern in 4/4 time with a fairly simple beat, and record the pattern as a mono rhythm loop sample.

1. Use "Sample Select" to select the sample data that you want to time-slice.

Play back the sample, and verify that the beats that you want to loop are played cleanly.

If they are not played cleanly, make the appropriate settings for the start address "Start" and end address "End," and execute the page menu command "Truncate" (See "Loop settings" on page 133).

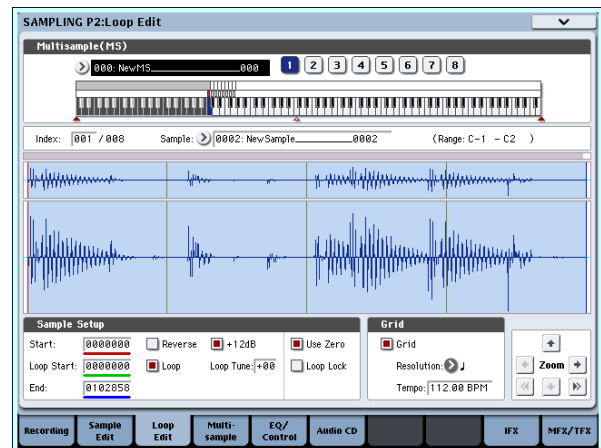

2. Access the P2: Loop Edit page. Select the page menu command "Time Slice."

The Set Sample Tempo dialog box will appear.

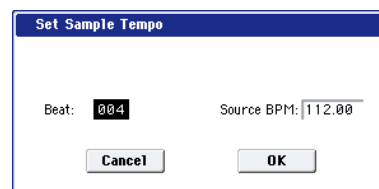

3. Specify the number of quarter-note beats in the sample, and its tempo.

If you know the BPM, set "Source BPM."

If you do not know the BPM, set "Beat" and the BPM will be calculated automatically.

4. Press the OK button.

The sample will automatically be sliced, and a dialog box will appear.

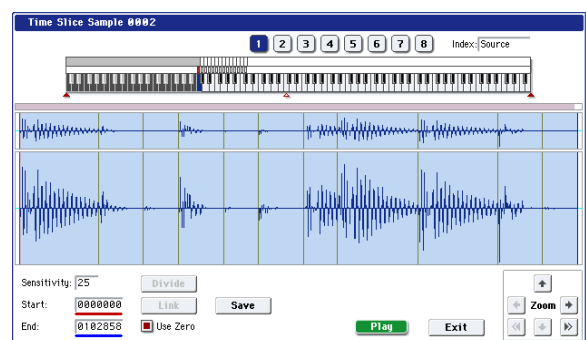

When you play the keyboard, C2 will play the original sample (Source), and D2 and subsequent keys will play the divided samples.

While listening to each divided sample, adjust "Sensitivity" so that each drum strike or other rhythm instrument sound is divided into its own sample. In some cases, it may not be possible to slice the sample cleanly even if you adjust "Sensitivity." If the attack of the next sound is included in the end of the preceding sample, or if one sample contains two notes, you will need to edit the samples.

If you want to edit, hold down the ENTER switch and select the "Index" that is assigned to the note that you want to edit. (This portion of the waveform display will be highlighted.) Then you can make

adjustments by adjusting “Start” or “End,” and by using Divide to separate or Link to combine. For more information, see “Time Slice” on page 629 of the Parameter Guide.

5. Press the Save button.

The Save Samples & MS dialog box will appear. Here you can save the time-sliced samples and the multisample.

At this time, set the items in the Save With area to specify the conversion destination for the program that will use the samples and multisample, and for the performance data (track or pattern) that will be used in Sequencer mode to “recreate” the rhythm loop sample.

- If you want to create the performance data in a track:

Turn “Program” and Seq.Event On (checked)
 Program: as desired (U-B000)
 Track: On
 Song: 000, Track: 01, Meter: 4/4
 Start Measure: 001, Time: 008

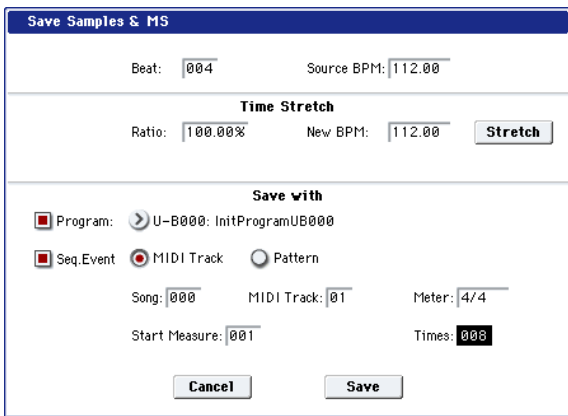

Press the Save button to save the data. You will return to the dialog box of step 4.

- If you want to create the performance data in a pattern
 In order to audition the performance data as it would be if created as a pattern, press the Save button once again to access the Save Samples & MS dialog box.

Turn “Program” and Seq.Event On (checked)
 Program: as desired (U-B001)
 Pattern: On
 Song: 001, Pattern: U00, Meter: 4/4
 RPPR: On (checked), Key: C#2, Track: 01

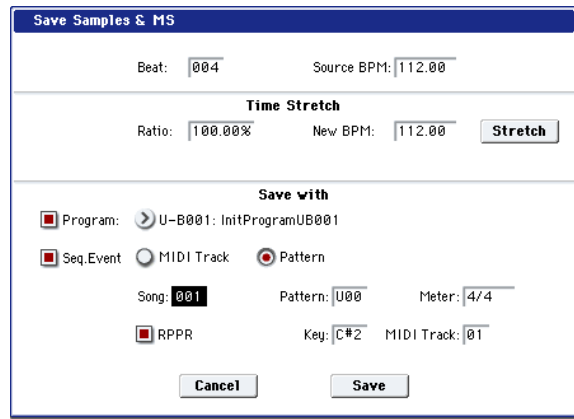

Press the Save button to save the data. You will return to the dialog box of step 4.

- 6. Press the Exit button.
- 7. Press the MODE SEQ switch to enter Sequencer mode, and select 000 for “Song Select.”

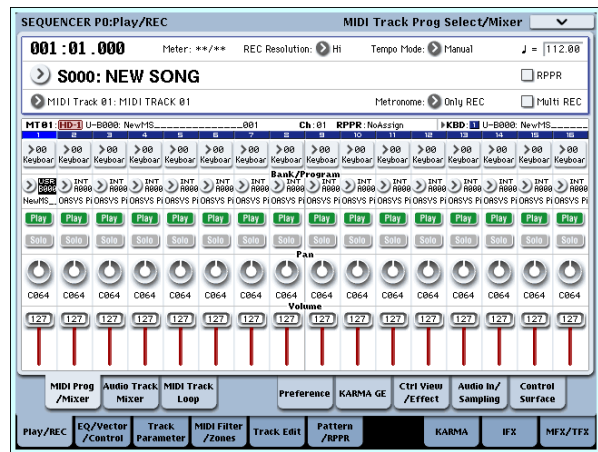

The following song data has been set/created automatically as you specified in step 5.

- P0: Play/REC page
 Song: 000, Meter: 4/4, Tempo: 112
- P0: Play/REC– MIDI Track Prog Select/Mixer page
 Track01 Program: as desired (U-B000)
- P5: Track Edit, Track Edit page
 Track01: track data: 8 measures (D2–)

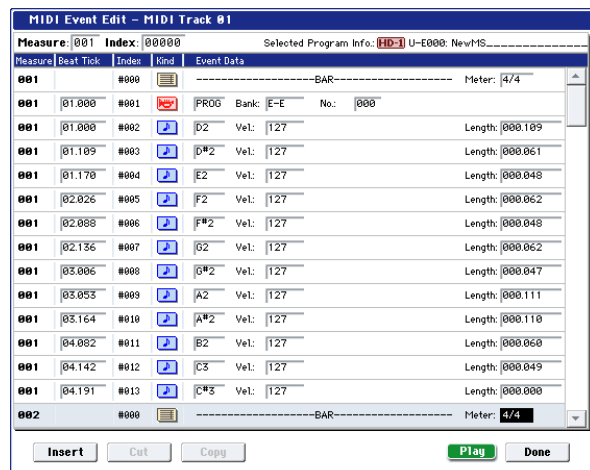

Press the SEQUENCER START/STOP switch to start playback.

As an example, set “♪(Tempo)” to 100. Notice that the pitch does not change when you play back at a different tempo.

If the beat of the original rhythm loop sample is not reproduced correctly when you change the tempo, or if obtrusive noise is heard, this is because the sample was not sliced appropriately in step 4. The way in which the percussion instrument sounds were divided will have a major impact on the quality of the playback when the tempo is changed. You will need to adjust the way in which the samples are divided in step 4.

The silence between samples may become obtrusive if you play back at a slower tempo, or noise may occur between samples if you play back at a faster tempo. To avoid such problems, you can set Stretch “New BPM” or “Ratio” in step 5 to the tempo at which you want to play back, and execute time stretch to adjust the length of each sample. For more information, see “Time Stretch” on page 634 of the Parameter Guide.

8. In “Song Select,” choose 001.

The following song data has been set/created automatically as you specified in step 5.

- P0: Play/REC page
Song: 001, Meter: 4/4, Tempo: 112, RPPR: On
- P0: Play/REC– MIDI Track Prog Select/Mixer page
Track01 Program: as desired (U-B001)
- P5: Pattern/RPPR, RPPR Setup page
Key: C#2, Assign: On,
Pattern: User, U00, Track: Track01
Pattern data: 1 measure (D2–)

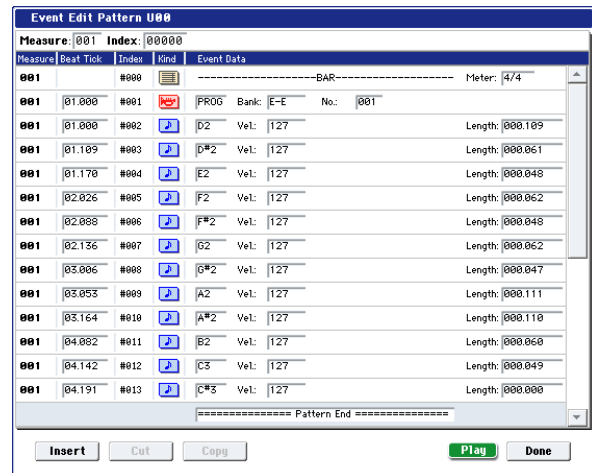
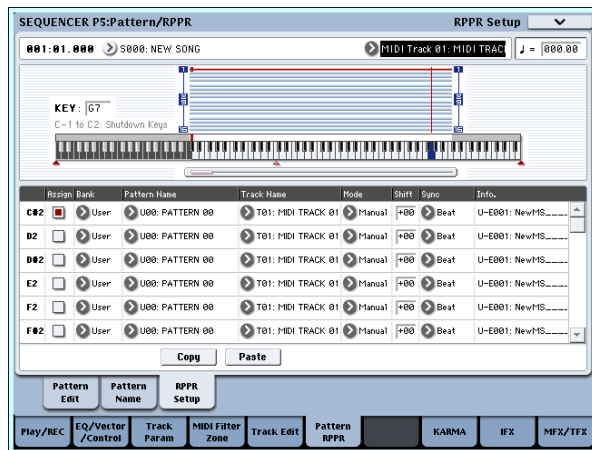

In the P0: Play/REC– MIDI Track Prog Select/Mixer page, press the C#2 key. The RPPR function will begin playing pattern U00.

In the P5: Pattern/RPPR, Pattern Edit page, press the SEQUENCER START/STOP switch to start playback of pattern U00.

When you press the C#2 key in the P5: Pattern/RPPR, RPPR Setup page, the RPPR function will start playing pattern U00.

In the same way as in step 7, changing the playback tempo will not affect the pitch.

Sample (waveform data) editing – P1: Sample Edit

Editing the waveform data.

In the P1: Sample Edit screen you can do the following things.

- You can set the Edit Range “Start” and “End” while watching the waveform. You can use functions such as Zoom In/Out, Use Zero, and Grid to edit the waveform efficiently.
- You can edit the sample waveform using a variety of commands such as cut, copy, mix, insert, normalize, volume ramp, and reverse.
- A Rate Convert function lets you lower the sampling frequency of the sample data in a range of 2/3 to 1/6, producing “down-sampled” effects.
- The Link function (Link: with crossfade) lets you connect two samples into one. When doing so, you can apply a crossfade so that the sustained portion of the samples will change gradually to create a natural transition between the two samples.

1. Select the sample that you wish to edit.

Use “Sample Select” or “Index” in the P1: Sample Edit page or the P0: Recording, Recording page to select the sample.

 If you use “Sample Select” to select the sample, be aware that the index assignment will also change.

2. Select the P1: Sample Edit page.

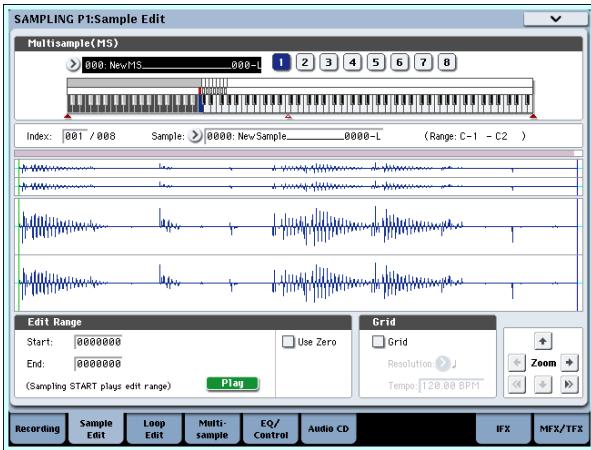

The waveform data of the currently selected sample will be displayed.

Sample waveforms that were recorded with a "Sampling Mode" of Stereo will be shown in two lines. The upper line is the L channel waveform, and the lower line is the R channel waveform.

3. Use "Edit Range Start" and "End" to specify the range that you wish to edit.

The selected range will be highlighted.

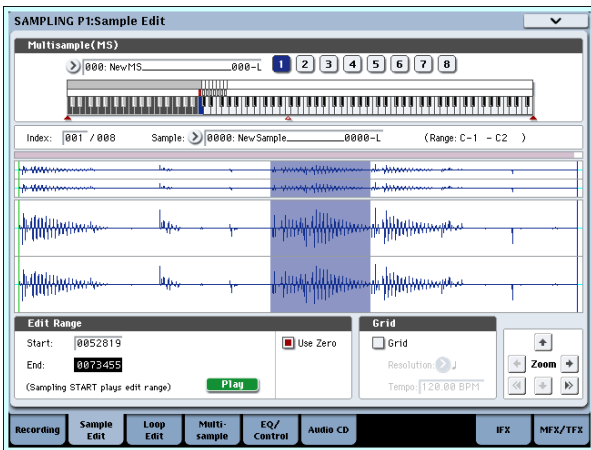

If you want to audition the selected region, press the Play button in the LCD or the SAMPLING START/STOP switch. The selected region will play at the pitch of the base key (the blue key in the keyboard display). You can specify the base key by holding down the ENTER switch and playing a note on the keyboard.

When you play a key to which the sample is assigned (the highlighted range of the keyboard displayed in "Keyboard & Pad"), the sample will be played back according to its loop settings.

The procedure for using the ZOOM and "Use Zero" check boxes is the same as for P2: Loop Edit.

4. From the list of page menu, select the desired editing command. Make the appropriate settings in the dialog box, and press the OK button to execute.

For details on the many sample editing features, see "Sampling: Page Menu Commands" on page 615 of the Parameter Guide.

Multisample editing – P3: Multisample Edit

Editing a multisample is accomplished with a number of operations i.e. creating indexes for the multisample and assigning a sample to each index, editing operations such as deleting, copying, and inserting indexes, and detailed settings such as sample level and pitch for each index.

Multisample editing is performed in P3: Multisample.

You can also do some basic edits in the P0: Recording-Recording page.

Editing the indexes

To change the number or order of the indexes, use the Insert, Cut, Copy, and Create buttons.

1. Select the P3: Multisample Edit page.

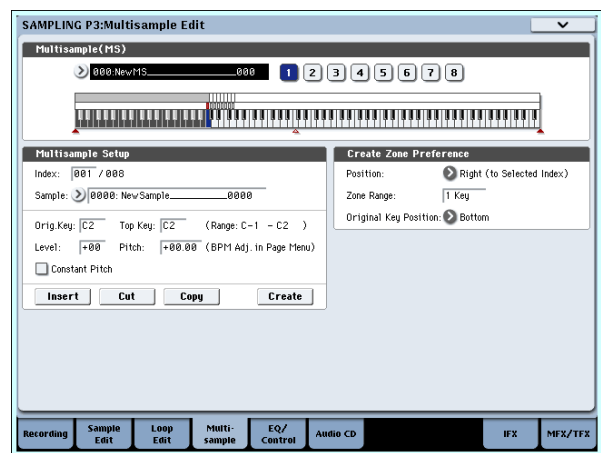

2. Use "Multisample (MS)" to select the multisample that you wish to edit.

3. Select the "Index."

You can also select an index by holding down the VALUE controller or ENTER switch and playing a note on the keyboard or pad.

4. Press the buttons to modify the number or order of the indexes, and edit them.

To delete the selected index, press the Cut button.

The Insert button is used in conjunction with the Cut and Copy buttons. The contents of the index that was Cut or Copied will be inserted.

The Create button has the same function as the Create button in P0: Recording (see "Creating multisample indexes and sampling – P0: Recording" on page 127).

Modifying the settings of an index

1. Make the settings described in steps 1–3 of "Editing the indexes."

2. Set parameters for the selected index.

- Use "Sample" to specify the sample for the selected index. You can also select a sample here.
- Use "Orig. Key (Original Key)" to specify the original key of the sample.
- Changing the "Top Key" will change the upper limit of the zone. Simultaneously, the lower limit of the next-numbered index will also change. "Range"

indicates the zone determined by the “Top Key” setting.

- **Level** adjusts the playback level of the sample. You can use this to ensure that all samples in a multisample have a consistent level.
- If you check “Constant Pitch,” all notes in the index zone will sound the sample at its original pitch.
- “Pitch” adjusts the sample pitch for each index. You can use the “Pitch BPM Adjust” page menu command to set the loop interval to the desired tempo. For more information, see “Pitch BPM Adjust” on page 638 of the Parameter Guide.

EQ adjustments for a multisample – P4: EQ/Controller

Here you can use a mid-sweepable three-band EQ to adjust the output of the multisample. You can also use the control surface to control the EQ.

Here you can also assign the functions of SW1/2, Real-Time Knobs 5–8, and the note numbers and velocities played by pads 1–8.

Ripping – P5: Audio CD

The OASYS allows you to “rip” digital audio data from an audio CD inserted in the internal CD-R/RW drive or in a USB-connected CD-ROM or CD-R/RW drive.

Ripping digital data from an audio CD

Here’s how digital data from an audio CD track can be captured as a sample. In this example we’ll explain how to rip using the internal CD-R/RW drive.

1. Access the Sampling P5: Audio CD page.

Press the MODE SAMPLING switch, and then press the Audio CD tab in the LCD screen.

2. Insert an audio CD into the internal CD-R/RW drive.

- ⚠ Use caution when handling the CD-R/RW drive. For details on how to insert and remove discs, see “Using the CD-R/RW drive” on page 41.

Next, make a few settings so that you can monitor the CD-R/RW Drive Audio Input. These settings don’t affect the ripping process itself.

3. For both the left and right channels, set Bus Select (IFX/Indiv.) to L/R, and Level to 127.

4. Set the left channel’s Pan to L000, and the right channel’s Pan to R127.

5. In “Drive” (Drive Select), choose the drive that contains the audio CD.

6. Raise the Volume.

7. Use Track to select the track that you want to rip.

8. Press the SEQUENCER START/STOP switch to play back the audio CD track.

9. During playback, press the ENTER switch at the points where you want ripping to begin and end. This will set Range Start and Range End.

If you press the ENTER switch three or more times, Range Start and Range End will respectively be set

The method given above applies when something other than Range Start or Range End is selected (highlighted).

If Range Start or Range End are selected (highlighted), the setting will be updated each time you press the ENTER switch.

If Range Start or Range End are selected (highlighted), this region will play back.

When you finish making settings, press the SEQUENCER START/STOP switch to stop playback of the audio CD.

10. Verify the region that will be ripped.

Select either “Region Start” or “Region End” (the display will be highlighted), and press the SEQUENCER START/STOP switch. The CD will play from Range Start to Range End and then stop.

If you want to adjust the location, use the VALUE controllers to modify the Range Start or Range End settings, or move the cursor to a parameter other than Range Start and Range End and repeat step 8 to make the setting once again.

If you want to move the track playback start location to the beginning of the track, press the LOCATE switch.

11. When you have finished setting Range Start and Range End, select the page menu command “Destination.”

A dialog box will appear.

Specify the destination to which the ripped sample will be written.

Select RAM if you want to rip the sample into RAM memory. In this case, you can also set Sample No. (L), (R) to specify the sample number that will be written. Normally you can leave this unchanged.

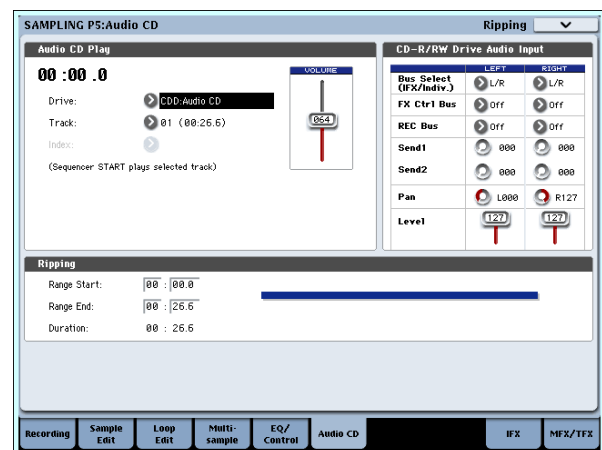

Select DISK if you want to rip the sample to media.

Use “Drive Select” to select the drive, and use the Open and Up buttons to select the directory in which the data will be saved. Also specify a name for the WAVE file that will be saved.

12. Press the OK button to execute ripping, or press the Cancel button to cancel without executing.

When you press the OK button, the “Obey Copyright Rules” dialog box will appear.

13. Carefully read COPYRIGHT WARNING on v, and if you consent to the terms, press the OK button to

begin ripping. If you do not consent to the terms, press the Cancel button to cancel the operation.

Saving multisamples and samples

If you want to keep the multisample and sample data you create, you must save your data onto either the internal hard drive, or an external USB storage device.

In Sampling mode if you want to save only the multisamples and samples, you can execute the “Save Sample Data” page menu command in the Disk– Save page. If you have converted a multisample into a program, or if you are using multisamples or samples that you created in Combination or Sequencer mode or a drum kit you created in Sampling mode, we recommend that you save your data using “Save All” in order to ensure that it will be reproduced correctly the next time you load it.

In Program, Combination, or Sequencer modes, we also recommend that you use “Save All.”

When you execute with Save All, the following data will be saved.

- Internal memory programs, combinations, global settings, drum kits, wave sequences
- Songs
- Multisamples and samples created in Sampling mode, etc.

 Unless you save to disk, any sample or multisample data you create will be lost when you turn off the power. For more information, see “How to save data” on page 169.

Converting a multisample to a program

In pages P0: Recording–P4: EQ/Controller, you can select and execute the “Convert MS To Program” page menu command. When you execute this command, the settings of the currently selected multisample will be converted into a program. In Program mode you can make filter, amp and effect settings etc., and play the sample as a program. The resulting program can be used in a combination or song.

If you want to use a multisample created in Sampling mode as a program, access the Program P2: OSC Pitch page and select RAM Mono or RAM stereo as the “Bank” for OSC1 Multisample/Wave Sequence or OSC2 Multisample/Wave Sequence “Bank” (when “Type” is set to Multisample). In this case, the multisample you created in Sampling mode will sound according to the settings of the program parameters.

1. Use “Multisample Select (MS)” to select the multisample that you want to convert to a program.
2. Choose “Convert MS To Program” to open the dialog box.

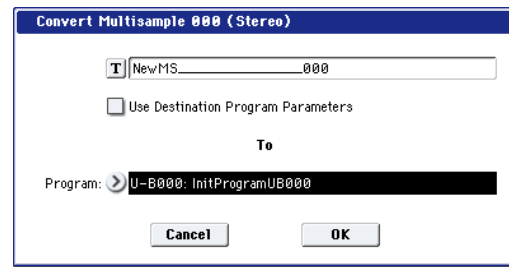

3. Press the text edit button to open the text edit dialog box, and input a new program name (up to 24 characters). By default, this will be the name of the multisample.

4. “Use Destination Program Parameters” unchecked:

When you execute, the multisample of the conversion-destination program will be replaced by the multisample you select here, and the other program parameters will be initialized. The program will reproduce the sound you heard in Sampling mode.

The program will be converted with an **Oscillator Mode** (Program 1–1a) of Single.

“Use Destination Program Parameters” checked: When you execute, the multisample of the conversion-destination program will be replaced by the multisample you select here, but the other program parameters will not be initialized. Choose this if you want to use the parameter settings of an existing program.

-  If you check “Use Destination Program Parameters,” please be aware of the following point.

The conversion-destination program’s **Oscillator Mode** must be Single. If this is not the case, a message of “Oscillator Mode conflicts” will appear when you attempt to execute. Please change the **Oscillator Mode** setting of the conversion-destination program.

5. Use the To “Program” field to specify the conversion-destination program.

We recommend that you use bank USER-E as the program bank for Sampling mode.

6. Press the OK button to execute.
7. Press the MODE PROGRAM switch to enter Program mode, select the converted program, and try it out.

Compare

In Sampling mode, there is no Compare function that lets you return to the state prior to editing.

If you want to preserve the state prior to editing, use a function such as “Copy Sample” or “Copy MS” to copy the multisample or sample before you begin editing. For more information, see “Copy Sample” on page 616 of the Parameter Guide, and “Copy MS (Copy Multisample)” on page 618 of the Parameter Guide.

In some of the page menu commands on the Sample Edit and Loop Edit pages, you can execute with the “Overwrite” option unchecked in the dialog box, so that the sample data prior to editing will be preserved.

Sampling in Program, Combination, and Sequencer modes

In addition to using Sample mode, you can also sample both external audio sources and internal sounds in Program, Combination, and Sequencer modes.

For instance, you can resample a performance that uses the OASYS's full range of features, including filters, effects, and KARMA. You can even sample a full, multitimbral sequence, played either from the internal sequencer or an external MIDI sequencer.

You can also sample the OASYS's performance together with audio from an external input source, or monitor the performance of the OASYS's KARMA function and sequencer etc. while you sample only the external audio from the input jacks.

In Sequencer mode, you can also sample an audio source that's being played along with the song, and the system will automatically create MIDI notes to play the new sample in sync with the song. You might use this to record a vocal or guitar part, for instance.

This is called In-Track Sampling.

Examples of sampling in Program or Combination modes

Resampling a phrase generated by the KARMA function in Program mode

You can resample the sound of a program or combination being played by yourself or by the KARMA function.

In this example, we'll explain how to sample a KARMA-generated phrase in Program mode. You can sample in a similar way in Combination or Sequencer modes as well.

1. Press the **MODE PROGRAM** switch to enter Program mode, and select the program that you want to resample.
2. Turn on the KARMA function (KARMA ON/OFF switch lit), play the keyboard, and verify that a phrase is generated.
3. Press the **Sampling** tab to access the **P0: Play–Audio Input/Sampling** page.

Make the following settings.

– Audio Input –

“Use Global Setting”: Off

Bus Select (IFX/Indiv.): Off

Turn all external inputs Off.

– RECORDING LEVEL–

Recording Level: 0.0

This is the default setting for resampling.

– Sampling Setup –

Source Bus: L/R

The sound sent to the L/R bus will be resampled.

“Trigger”: Note On

Sampling will start the moment you play the keyboard.

“Save to”: RAM

Sampling will occur to RAM memory.

“Mode”: Stereo

The sound of the internal L/R channels will be sampled in stereo.

Tip: The OASYS will automatically make the above settings for you if you execute the “Auto Sampling Setup– Resample Program Play” page menu command. In addition, it will also assign the Multisample to a new Program after you've finished resampling. For more information, see “Auto Sampling Setup” on page 141.

4. Adjust the recording level.

Press the **SAMPLING REC** switch and use the **Recording Level** slider to adjust the level.

Play with the KARMA function turned on, and use the **VALUE** slider to adjust the **Recording Level** slider as high as possible without allowing the “CLIP!” indication to appear.

When you've finished making adjustments, press the **SAMPLING REC** switch.

Press the **KARMA ON/OFF** switch to turn the KARMA function off.

5. Sample.

Press the **KARMA ON/OFF** switch to turn it on.

Press the **SAMPLING REC** switch.

Press the **SAMPLING START/STOP** switch to put the OASYS in record-ready mode.

Play the keyboard.

Recording will start the moment you play the keyboard.

While recording continues, all the sound you produce using the keyboard or controllers will be recorded.

Press the **SAMPLING START/STOP** switch to stop recording.

6. Listen to the sound you resampled.

Access the **Sampling P0: Recording– Recording** page. Press the **MODE SAMPLING** switch, then the **EXIT** switch, and then the **Recording** tab in the upper line of the LCD screen.

Use “Multisample Select” to select the multisample that you resampled.

Play the **C2** key to hear the resampled sound.

7. If you want to convert this multisample into a program, choose the “Convert MS To Program” page menu command, select the desired program, and execute the conversion.

For more information, see “Converting a multisample to a program” on page 140.

Auto Sampling Setup

This function automatically sets various sampling-related parameters in each mode. You can use this function when you're resampling your performance in Program, Combination, or Song modes, or as a guideline when sampling an external audio source. You can also use this function to initialize the settings.

In this example we'll explain how you can use **Auto Sampling Setup** to make the settings described above in the preceding section.

1. Carry out steps 1 and 2 described in the preceding section.
2. Press the **Audio Input/Sampling** tab to access the **P0: Play– Audio Input/Sampling** page.
3. Choose the **Auto Sampling Setup** page menu command. A dialog box will open.
4. Make the following settings in the dialog box.

“Resample Program Play”: On

This makes the appropriate settings for resampling your playing on a program.

“Save to”: RAM

The resampled data will be written into RAM memory.

“Convert to Program”: On

“Program”: as desired

After resampling, the data will automatically be converted into the program number you specified in “Program.”

5. Press the **OK** button to execute the command.
The OASYS will make the appropriate settings for resampling.
6. Resample your playing as described in steps 4 and 5 of the preceding section.
7. Listen to the sound you resampled.
Access the Program P0: Play– Main page. Press the **MODE PROGRAM** switch, then the **EXIT** switch, and then the **Main** tab in the upper line of the LCD screen.
Select the program you specified for “Program” in the dialog box.
Play the **C2** key and you will hear the sound you resampled.

Mixing a KARMA-generated drum phrase with a live guitar input, and sampling the result

Here's how you can resample KARMA together with an external audio input source.

In this example, we will explain how a guitar connected to the **AUDIO INPUT** jack can be played along to a drum phrase played by the OASYS, and how both can be sampled together.

Sampling can be performed in a similar way in **Combination** and **Sequencer** modes as well as in **Program** mode.

1. Press the **MODE PROGRAM** switch to enter **Program** mode, and select the drum program that you want to resample.
2. Turn the **KARMA** function on (**KARMA ON/OFF** switch lit), play the keyboard, and verify that the drum phrase plays.
Turn **LATCH** on. Press the **LATCH** switch to make it light.
Also adjust the tempo “♪” as desired.

3. Press the **KARMA ON/OFF** switch to turn off the **KARMA** function.
4. Connect your guitar to the rear panel **AUDIO INPUT 1** jack.

Press the **AUDIO INPUT MIC/LINE** switch inward to select the **LINE** position, and set the **LEVEL** knob at about the center.

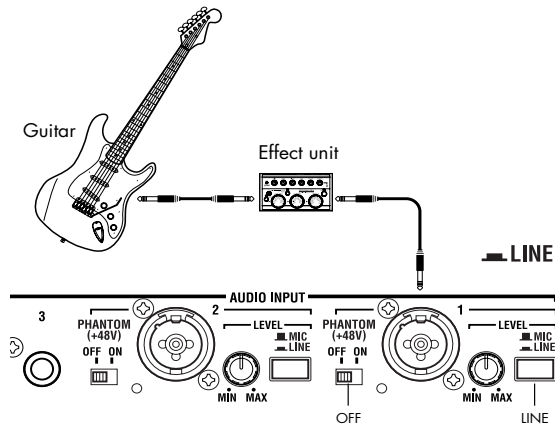

⚠ If you connect a guitar with passive pickups (i.e., a guitar that does not contain a preamp), you will be unable to sample it at the correct level because of the impedance mismatch. Such guitars should be routed through a preamp or an effect unit.

5. Press the **Sampling** tab to access the **P0: Play– Audio Input/Sampling** page.

Make the following settings.

– Audio Input –

Use Global Setting: Off
INPUT1

Bus Select (IFX/Indiv.): L/R

Pan: as desired

Level: 127

REC Bus: Off

The input from **AUDIO INPUT 1** will be sent to the L/R bus.

– **RECORDING LEVEL**–

Recording Level: 0.0

This is the default setting for resampling.

– **SAMPLING SETUP** –

Source Bus: L/R

The sound sent to the L/R bus will be sampled.

Trigger: Sampling **START SW**

Press the **SAMPLING REC** switch to enter record-standby mode. Then press the **SAMPLING START/STOP** switch to start sampling.

Metronome Precount: 4

When you press the **SAMPLING REC** switch to enter record-standby mode and then press the **SAMPLING START/STOP** switch to start sampling, a four-beat count will sound, and then recording will begin. (The metronome will not sound during recording.)

Save to: RAM

The sample will be recorded to RAM memory.

Mode: Stereo

The sound of the internal L/R channels will be sampled in stereo.

– Metronome Setup–

Bus (Output) Select: L/R

Level: as desired

The output of the metronome will be sent to the L/R bus.

6. Play your guitar at the volume that you will be recording.

If the display indicates “ADC OVERLOAD !” (AD converter input overload), turn the rear panel [LEVEL] knob toward MIN to adjust the level appropriately.

The best audio quality will be obtained at the highest possible level that does not cause an overload; i.e., a level that is slightly below the point where “ADC OVERLOAD !” is displayed.

7. Press the SAMPLING REC switch.

Play your guitar, and the level meter will indicate the volume at which the guitar will be sampled.

Press the KARMA ON/OFF switch to turn it on, play the keyboard to start the drum phrase, and play your guitar while adjusting the final volume.

If the “CLIP!” indication appears, use the VALUE controller to lower the **Recording Level** slider (located in the right side of the display) below +0.0 to an appropriate level.

If the balance between instruments is not to your liking, use the LEVEL knob or the performance editor “Amp Level” to adjust the balance.

8. When you have finished making adjustments, press the SAMPLING REC switch.

Press the KARMA ON/OFF switch to turn off the KARMA function.

9. Press the KARMA ON/OFF switch to turn it on, and then press the SAMPLING REC switch to enter record-ready mode.

When you press the SAMPLING START/STOP switch, a count-down will begin. Play the keyboard during the count-down.

After a four-beat count-down, recording will start. Play your guitar. The KARMA function will also start after the count-down.

10. Press the SAMPLING START/STOP switch to stop recording.

11. Press the KARMA ON/OFF switch to turn it off.

12. Listen to the sound that was sampled.

Access the Sampling P0: Recording– Recording page. Press the MODE SAMPLING switch, then the EXIT switch, and then the Recording tab in the upper line of the LCD screen.

Use “Multisample Select” to select the multisample that you resampled.

Play the C2 key, and you will hear the sound that was resampled.

13. If you want to convert this multisample into a program, choose the “Convert MS To Program” page menu command, select the desired program,

and execute. (See “Converting a multisample to a program” on page 140)

Sampling a guitar from the audio inputs, while listening to a KARMA-generated drum phrase

Here we’ll explain how you can sample just the sound of an external input source while listening to a performance generated by the KARMA function.

You can do this by modifying the settings in step 5 of the preceding “Mixing a KARMA-generated drum phrase ...” to change them as follows.

INPUT1

Bus Select (IFX/Indiv.): Off

REC Bus: 1

The input from AUDIO INPUT 1 will be sent to REC bus 1.

– Sampling Setup –

Source Bus: REC 1/2

The sound sent to REC bus 1/2 will be sampled. The sound of the internal tone generator sent to the L/R bus will not be sampled.

Mode: L–Mono

The sound of the internal L channel will be sampled in monaural.

Modify the settings as shown above, sample your playing, and then listen to the sample.

Examples of sampling in Sequencer mode

In-Track Sampling

When you sample an external audio source while listening to the song playback, the In-Track Sampling function automatically creates the appropriate note data in a track.

When you play back the song, the automatically-created note data will trigger the multisample that was automatically converted to a program.

In this example, we’ll show the sound of a guitar connected to the AUDIO INPUT 1 jack can be added to your song.

1. In Sequencer mode, select the song to which you want to add the guitar sound.

You can either create a song, or use Disk mode to load a previously-created song.

2. Connect your guitar to the rear panel AUDIO INPUT 1 jack.

Press the AUDIO INPUT MIC /LINE switch inward to select the LINE position, and set the LEVEL knob at about the center.

 If you connect a guitar with passive pickups (i.e., a guitar that does not contain a preamp), you will be unable to sample it at the correct level because of the impedance mismatch. Such guitars should be routed through a preamp or an effect unit.

3. Access the Sequencer P0: Play/REC– Audio Input/Sampling page.

- We will be modifying the Audio Input settings, so turn the Input "Use Global Setting" off.
- Choose the Auto HDR/Sampling Setup page menu command.

The dialog box will appear.

- Choose "In-Track Sampling."

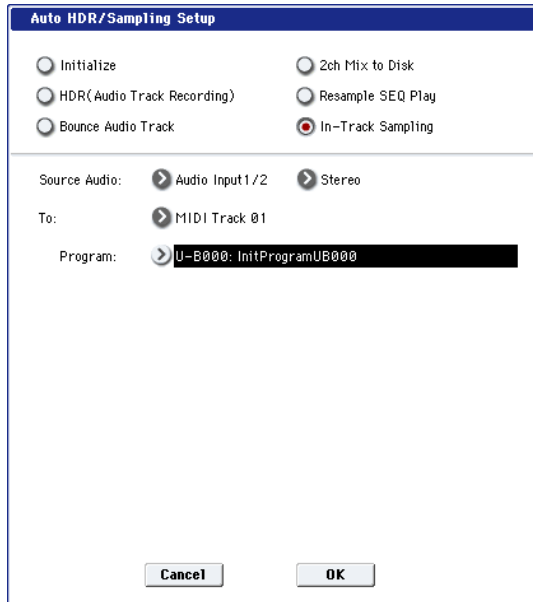

- Make the following settings for "In-Track Sampling."

Source Audio: Audio Input 1/2

The input from the AUDIO INPUT 1 and 2 jacks will be sampled.

Mono-L/Mono-R/Stereo: Stereo

The sound will be sampled in stereo.

To: as desired

The track you want to use for In-Track Sampling. MIDI note data to trigger the sample will be recorded in the track you selected.

Program: as desired

The convert-destination program number. When sampling is completed, a new multisample will be automatically created, converted to a program, and assigned as the program for the track.

- Press the OK button to execute the command.

Preparations for In-Track Sampling are now completed.

Let's take a look at the settings that were made.

– Audio Input –
INPUT1

Bus Select (IFX/Indiv.): Off

Pan: L000

Level: 127

REC Bus: 1/2

The input from AUDIO INPUT 1 will be sent to REC bus.

– RECORDING LEVEL –

Recording Level: 0.0

This is the default setting for sampling.

– Sampling Setup –

Source Bus: REC 1/2

The sound sent to REC 1/2 bus will be sampled.

Trigger: Sampling START SW

Press the SAMPLING REC switch to enter recording-standby mode. Then press the SAMPLING START/STOP switch to start sampling.

Save to: RAM

The sample will be recorded to RAM memory.

Mode: L-Mono

The sound of the internal left channel will be sampled in mono.

- For this example, change the settings as follows.

Pan: C64

"Trigger": Threshold, **"Threshold Level":** as desired

"Sample Time": as desired

- Play your guitar at the volume that you will be recording.

If the display indicates "ADC OVERLOAD !" (ADC converter input overload), turn the rear panel [LEVEL] knob toward MIN to adjust the level appropriately.

For the best sound, adjust the level as high as possible without allowing the "ADC OVERLOAD !" indication to appear.

- Press the SAMPLING REC switch.

When you play your guitar, the level meter will indicate the volume at which the guitar will be sampled.

If the display indicates "CLIP!," use the VALUE controllers to lower the **Recording Level** slider (in the right of the display) below +0.0 to an appropriate level.

- When you have finished making adjustments, press the SAMPLING REC switch.

- Press the SAMPLING REC switch, and then the SAMPLING START/STOP switch to enter recording-standby mode.

Press the LOCATE switch to reset the song playback location to the beginning of the song, and press the SEQUENCER START/STOP switch to play back.

Begin playing at the point where you want to record.

Sampling will begin when the **Threshold Level** volume is exceeded.

- At the point where you want to stop sampling, press the SEQUENCER START/STOP switch.

Song playback and sampling will end.

Sampling will also stop if the specified **Sample Time** is reached.

- Press the LOCATE switch to return to the beginning of the song, and press the SEQUENCER START/STOP switch. Notice that the sampled audio is played back along with the song.

For details on how the Compare function works for In-Track Sampling, refer to "In-Track Sampling" on page 143.

Resampling a song to create a Wave file

You can record a completed Song to a stereo WAVE file, and then burn that WAVE file to an audio CD using the internal CD-R/RW drive. For more information, see "Creating and playing audio CDs" on page 175.

1. In Sequencer mode, select the song from which you want to create a WAVE file.

Either create a song, or use Disk mode to load a previously-created song.

 A maximum of 80 minutes for either mono or stereo can be written to media in one sampling operation (mono: approximately 440 MB, stereo: approximately 879 MB).

2. Access the Sequencer P0: Play/REC– Audio Input/Sampling page.

3. We will be modifying the Audio Input settings, so turn the Input "Use Global Setting" off.

4. Choose the Auto HDR/Sampling Setup page menu command.

A dialog box will appear.

5. Choose "2ch Mix to Disk."

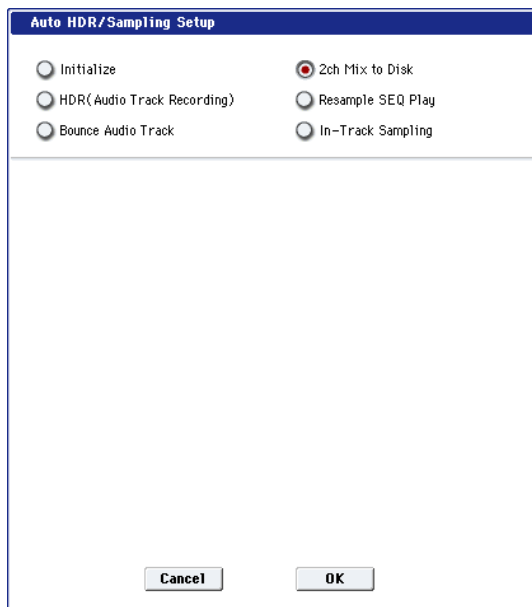

6. Press the OK button to execute the command.

Preparations for In-Track Sampling are now complete.

– Audio Input –

INPUT1–4, S/P DIF L, R

Bus Select (IFX/Indiv.): Off

REC Bus: Off

Turn off all input from INPUT 1–4 and S/P DIF L, R.

– RECORDING LEVEL–

Recording Level: 0.0

This is the default setting for resampling.

– Sampling Setup –

Source Bus: L/R

The sound sent to L/R bus will be sampled.

"Trigger": Sequencer START SW

Press the SAMPLING REC switch and

START/STOP switch to enter record-standby mode.

Then press the SEQUENCER START/STOP switch to start recording.

Save to: DISK

The sample will be saved on the media you specified in "Select Directory."

Mode: Stereo

The sound of the internal L/R channels will be sampled in stereo.

7. Select the page menu command Select Directory, and specify the destination to which the WAVE file will be written.

Use "Drive Select" and the Open and Up buttons to select the directory in which the WAVE file will be saved.

Press the text edit button to access the text edit dialog box, and input a filename (up to six characters).

Leave **Take No.** checked. The number at the right of **Take No.** will be input as the last two characters of the filename.

This number will increment each time you sample, ensuring that the filename will not be the same even if you sample repeatedly.

After you have made the settings, press the Done button to close the dialog box.

8. Set Sample Time to the length that you want to sample.

Set this to a length slightly greater than the length of the song.

9. Set the recording level.

Press the SAMPLING REC switch.

Note: It will take between several seconds to nearly a minute from the moment you press the SAMPLING REC switch until the OASYS enters standby mode (i.e., until the SAMPLING REC switch changes from blinking to lit). This time is required in order to allocate sufficient space on the disk.

Press the SEQUENCER START/STOP switch to play back the song, and adjust the sampling volume while you watch the level meters. The default setting is 0.0 dB. If the level is too low, use the VALUE controller to raise the level as high as possible without causing the "CLIP !" indicator to appear.

When you finish making adjustments, press the SAMPLING REC switch.

Press the SEQUENCER START/STOP switch to stop the song playback. Then press the LOCATE switch.

10. Start sampling.

Press the SAMPLING REC switch and then the SAMPLING START/STOP switch to enter recording-standby mode.

Press the SEQUENCER START/STOP switch to play back the song. Sampling will begin at the same time.

When the song finishes playing back, press the SAMPLING START/STOP switch to stop sampling.

Use the page menu command “Select Directory” to verify that the WAVE file was created. Select the file and press the SAMPLING START/STOP switch to listen to the sound that was sampled.

Settings for the entire OASYS (Global mode)

How Global mode is structured

In Global mode you can make overall settings that apply to the entire OASYS, such as master tune, key transpose, effect global switch, global MIDI channel, and system clock.

In addition, you can create user drum kits, wave sequence, and scales, make settings for the damper pedal and assignable foot switches/pedals, and specify category names for programs and combinations.

 The edits you perform in Global mode will be preserved until the power is turned off, but will not be preserved after the power is turned off unless you first save your settings. Three types of data are handled in Global mode: wave sequence settings (Global P4), user drum kit settings (Global P5), and all other global settings (Global P0–P3). Each of these can be written into their respective memory area. This data can also be saved to various types of media in Disk mode.

For more information, see “Writing global settings” on page 167, “Saving to disks, CDs, and USB media” on page 168.

 Note that **Compare** can't be used in Global mode, with the exception of Wave Sequence and Drum Kit editing.

Global mode page structure

Page	Explanation
P0: Basic Setup	<ul style="list-style-type: none">• Basic settings for the entire OASYS• Audio input settings for use outside of Sampling mode (for Use Global Setting)
P1: MIDI	<ul style="list-style-type: none">• MIDI-related settings for the entire OASYS• MIDI controller settings in External mode
P2: Controller /Scale	<ul style="list-style-type: none">• Controller settings for the pedals etc. connected to the rear panel• CC settings for the KARMA controllers, pads, and VJS• User registered scale settings. Specify 16 octave scales, and one all-note scale.
P3: Category Name	<ul style="list-style-type: none">• Edit category/sub category names for programs, combinations and KARMA
P4: Wave Sequence	<ul style="list-style-type: none">• Edit wave sequence
P5: Drum Kit	<ul style="list-style-type: none">• Edit drum kits

Note: For details on how to access each mode and page, please see “Basic operations” on page 34.

P0: Basic Setup

Tuning to another instrument/Transposing

“Master Tune” adjusts the overall pitch. Edit this setting when you are playing the OASYS with other instruments, or when playing along with music on CD or tape. You can adjust the pitch in a range of ± 50 cents (one semitone = 100 cents). If this is at 0, middle A is tuned to 440 Hz.

Key Transpose shifts the pitch in semitone steps. Edit this setting when you want to transpose the sound of the entire OASYS. You can adjust the transposition in a range of ± 1 octave.

Adjusting the way in which velocity or after touch will affect the volume or tone

You can adjust the way in which changes in velocity or after touch will affect the volume or tone. This lets you (for example) make the volume of the notes more consistent, even when they are played with varying dynamics.

Each curve has its own character, so you can select the curve that is appropriate for your own playing dynamics, playing style, and the effect that you wish to obtain.

Velocity Curve selects the velocity curve, and **After Touch Curve** selects the aftertouch curve.

Bypassing the effects

Insert effects, master effects, and total effects can be bypassed globally. This applies to the entire OASYS regardless of the mode. For example, if you've connected the OASYS's outputs to an external mixer and are using an external effect processor to apply reverb or chorus to the sound, you can turn off the OASYS's master effects and total effects.

If the Effect Global SW “IFX 1–12 Off,” “MFX1&2 Off,” and “TFX1&2 Off” items are checked, the insert effects, master effect, will respectively be bypassed.

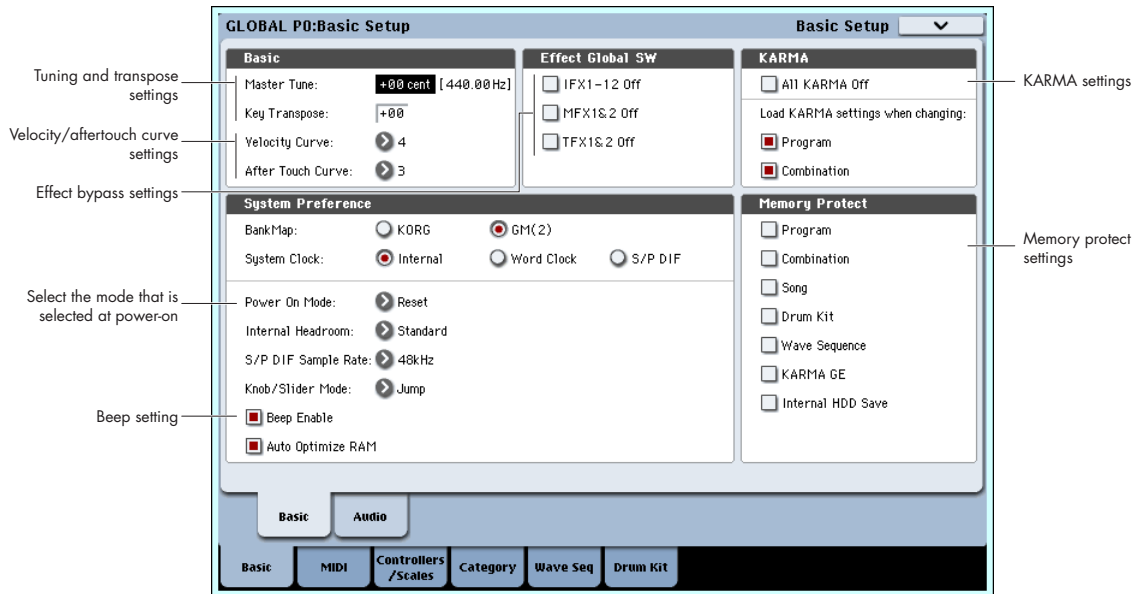

Linking KARMA to programs and combinations

You can specify whether the KARMA settings written to a program or combination will also be selected when you select that program or combination, or whether the KARMA settings will not change when you switch the program or combination.

When the OASYS is shipped from the factory, the former setting is selected. You can use the latter setting if you want to use the same KARMA settings to generate phrases and patterns while you select and try out different programs and combinations.

If the **Load KARMA Settings When Changing Program** or **Combination** boxes are selected, selecting a program or combination respectively will also select the KARMA settings that are written in that program or combination.

Globally disabling KARMA

If **All KARMA Off** is enabled, all KARMA functionality will be turned off. KARMA will not operate even if the KARMA ON/OFF switch is on.

Recalling the last-selected mode and page at power-on

The state of OASYS when the power is turned on will depend on the setting of “Power On Mode”.

If **Power On Mode** is set to Reset (factory setting), OASYS will automatically select the Combination mode P0: Play.

If **Power On Mode** is set to Memorize, OASYS will power on using the same mode and page that were selected when the power was turned off.

Sounding a beep when you press the LCD screen

If **Beep Enable** is selected, a beep will sound when you press an object in the LCD screen. Uncheck this item if you don’t want a beep to sound.

Protecting the memory

If one or more of the **Memory Protect** check boxes are checked, operations such as writing, loading, or song recording will be prohibited for the corresponding type of memory.

Global audio settings

Making audio input settings for all modes, except Sampling mode

The settings on the Audio tab select the input source for the analog/digital audio signal, the input level, bus, and master effect sends for use in all of the modes (Program, Combi, etc.) except for Sampling mode. If you want to use these settings, check the **Use Global Setting** option in the desired Program, Combi, or Song.

MIDI-related settings P1: MIDI

MIDI Setup, MIDI Filter, External

Here you can make MIDI settings for the entire OASYS. You can also use the menu commands of this page to transmit MIDI System Exclusive data dumps.

Pedal and other controller settings

The Controller tab of the Controller/Scale page lets you control how the footswitches and foot pedal will work, as well as setting up controller mappings for the KARMA controls and the drum/chord pads.

Specifying the function of the ASSIGNABLE Switch and ASSIGNABLE Pedal

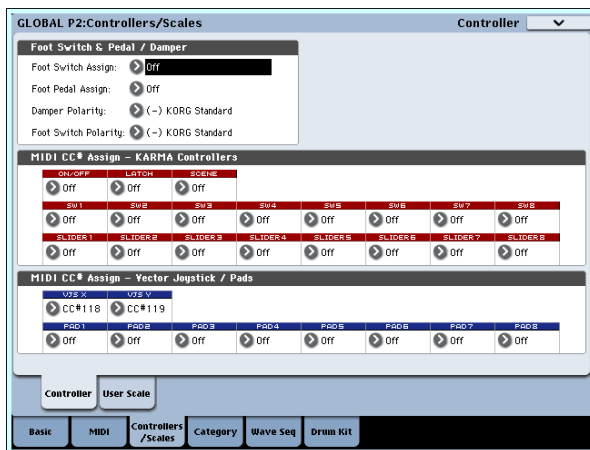

Assignable Switch

Foot Switch Assign lets you assign a function to a footswitch, such as the optional Korg PS-1, connected to the rear-panel ASSIGNABLE SWITCH jack.

You can choose from the following functions:

- Alternate modulation source
- Effect dynamic modulation source
- Switch portamento on/off
- Control the sostenuto effect
- Turn the soft pedal effect on/off
- Select programs or combinations (up/down)
- Start/stop the sequencer
- Punch-in/out on the sequencer
- Tap tempo
- KARMA on/off
- The functions of controllers such as the joystick or ribbon controller

Assignable Pedal

You can specify the function that will be performed by an assignable pedal (the optional XVP-10 EXP/VEL pedal or EXP-2 foot controller) connected to the ASSIGNABLE PEDAL jack.

Here you can also assign the functions that the faders, knobs, and switches will have when the control surface CONTROL ASSIGN EXTERNAL is on.

- This is set by “Foot Pedal Assign.”
You can choose from the following functions.
- Master volume
- Alternate modulation source
- Effect dynamic modulation source
- Portamento pitch change speed
- Volume
- The pan following an insert effect
- Pan
- Volume
- Send levels to the master effects
- Duplicate the function of another controller, such as the joystick or ribbon

Note: You can use this as a source for alternate modulation or effect dynamic modulation, and use it to control program parameters or effect parameters. In this case, set “Foot Switch Assign” to Foot SW (CC#82), and “Foot Pedal Assign” to Foot Pedal (CC#04).

Changing Programs and Combinations with the the foot switch

1. Press the “Foot Switch Assign” popup button, and select either Program Up or Program Down.

Program Up will cause the next higher program number to be selected each time you press the foot switch.

Program Down will cause the next lower program number to be selected each time you press the foot switch.

2. Set the “Foot Switch Polarity” to the polarity of the foot switch you have connected.

If you have connected a Korg PS-1 pedal switch, set this to (–) KORG Standard. If the polarity is not set correctly, the pedal will not function appropriately.

3. Either press the PROG switch to enter Program P0: Play, or press the COMBI switch to enter Combination P0: Play.

When you press the foot switch, the program/combination will change.

KARMA, Pad, Vector

You can assign control change messages to the KARMA switches and sliders, pads 1–8, and vector joystick X-axis and Y-axis. You can assign control change messages or note numbers to pads 1–8. (See PG p.161)

Normally you will use the default settings. To restore the default settings, execute the “Reset Controller MIDI Assign” page menu command and choose Default Setting.

Creating user scales

Creating an original scale, and assigning it to a Program

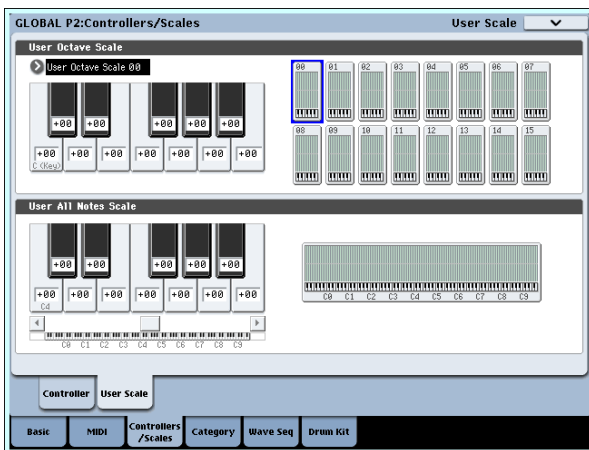

On the User Scale page, you can create your own original scales. These include sixteen different User Octave Scales, in which the pitch of each note of the octave is repeated for all octaves, and one User All Note Scale, in which the pitch of each of the 128 notes can be specified independently.

By adjusting the pitch of each key in the range of ± 99 cents, you can raise or lower it by approximately one semitone relative to the normal pitch.

The user scales you create here can be used by specifying the scale for a program, for each timbre of a combination, or for each track of a song.

You can choose these scales from the following pages.

Mode	Page
Program	P1– Program Basic: Scale
Combination	P2– Pitch: Scale, Use Program’s Scale
Sequencer	P2– Pitch: Scale, Use Program’s Scale

Here is how to set the scale type for each timbre in Sequencer mode.

1. Create a user octave scale or a user all notes scale.

Select a key, and use the VALUE controllers to adjust the pitch. The range of ± 99 raises or lowers the pitch approximately one semitone above or below the standard pitch.

Note: You can also select a key by holding down the ENTER switch and playing the desired note on the keyboard.

Note: You can copy one of the preset scales and edit it to create an original scale. To do so, use the page menu command “Copy Scale.”

2. Press the SEQ button to enter Sequencer mode.

3. Press the Track Param tab and then the Pitch tab to access the P2: Trk Param– Pitch page.

4. If you want the Track to use the scale saved with its individual Program, check the track’s “Use Program’s Scale” check box.

Tracks that are not checked will use the scale specified by Scale “Type (Song’s Scale).”

5. Set “Type (Song’s Scale)” to select the scale for the currently selected song.

Setting Category Names for Programs, Combinations, and KARMA

Program, Combination, KARMA Category

The Category Name pages let you assign names to the Program, Combination, and KARMA categories and sub-categories.

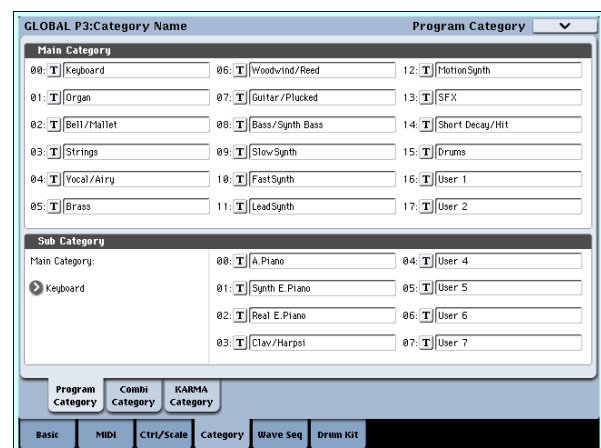

Using Wave Sequences

Wave Sequence Overview

What's a Wave Sequence?

Wave Sequences play back a series of different Multisamples over time. You can use this to create a variety of unique timbral and rhythmic effects, as described below.

Wave Sequences are similar to Drum Kits, in that you create and edit them in Global mode, and then use them in Programs. In HD-1 Programs, you can use Wave Sequences just as you would normal Multisamples, including velocity switches or crossfades, layering different Wave Sequences on the two Oscillators, and so on.

Also like drum kits, when you play a Wave Sequence in Global mode, it will use the settings from the previously selected Program or Combi.

You can create many different effects with wave sequences, from subtle to extreme. Here are descriptions of three common uses: rhythmic Wave Sequences, crossfading Wave Sequences, and velocity-switched Wave Sequences.

Rhythmic Wave Sequences

Rhythmic Wave Sequences use short or abrupt crossfades, so that transitions between the different Multisamples create a rhythmic phrase. Flexible swing amount, rests, and ties let you build complex patterns, which you can then sync to KARMA and the system tempo.

Programming Basics

The Wave Sequence parameters are spread over two pages. The **Seq Parameters** page has controls for the Wave Sequence as a whole, such as the start and end steps, looping, and modulation.

The **Step Parameters** page goes deeper into the structure of the Wave Sequence, allowing you to edit each of the 64 Steps.

Programs, Combinations, and Songs also have a handful of Wave Sequence-related parameters, to make it easier to fit Wave Sequences in with other sounds and rhythmic components (such as KARMA).

The Wave Sequence graphic, shown on both the **Seq Parameters** and **Step Parameters** pages, gives you a quick overview of the sequence, at a glance:

- The current step is marked by a red arrow.
- Red boxes are Multisample steps.
- Green boxes are Tie steps.
- White boxes are Rest steps.
- The length of the Wave Sequence, from the Start Step to the End Step, is shown by a rectangular outline.
- The Loop is highlighted in blue.

Crossfading Wave Sequences

By using long durations and crossfade times, Wave Sequences can produce complex, evolving timbres. Modulating the Start Step, Position, and Duration makes the sound even more organic, so that every note can play the Wave Sequence a little differently.

Velocity-Switching Wave Sequences

By setting each step's duration to GATE, and then modulating the Start Step by velocity, you can create a sound with up to 64 velocity switches. For instance, you can use this to switch between a large number of different attack transients.

Wave Sequence banks

The 150 Wave Sequences in the Internal bank (I-000 through I-149) are the built-in "factory" sounds. You can over-write them if you wish, but doing so may change the sounds of the Programs and Combis in banks INT A–E.

U–A through U–G are user banks. You can use these for storing sounds that you create yourself, optional sound banks from Korg, or third-party sound libraries. Each User bank contains 32 Wave Sequences.

- On the **Step Parameters** page, the horizontal scrollbar at the top of the graphic shows you the eight steps currently displayed on the screen.
- At the bottom right of the graphic is a **Solo** button. When this is turned on, the Wave Sequence will play only the current step, including its fade-in and fade-out.

Wave Sequence graphic

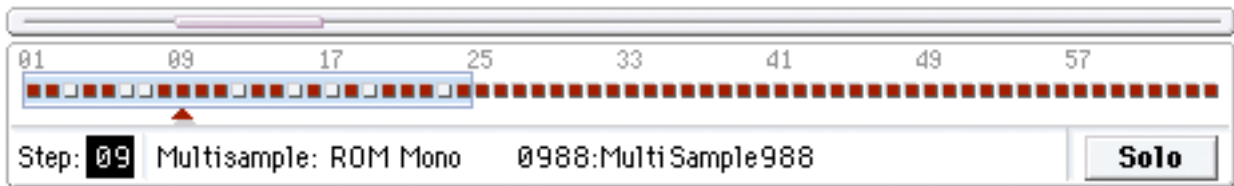

What's in a step?

Wave Sequences have 64 steps (although you don't have to use all of them—see “Setting the length of the sequence” on page 152). Each step includes:

- A “type” setting, which makes the step either play a Multisample, continue the previous step like a tied note, or play only silence like a musical rest.
- A selected Multisample, which sets the basic sound of the step.
- Multisample Reverse and Start Offset parameters, which modify the basic sound of the Multisample.
- Volume, coarse tuning, and fine tuning for the Multisample.
- A duration, which controls how long the step lasts. You can set the duration in either milliseconds or musical beats.
- A crossfade time, which sets how long it takes to fade into the *next* step.
- Fade-in and fade-out shapes for the crossfade, for subtle control of the transition between this step and the next step.
- Two AMS output values, which can be used to control other Program parameters.

Setting the length of the sequence

You can use anything from 1 to 64 steps in a Wave Sequence. You also don't have to start on step 1. To set the length of the sequence:

1. Go to the **Seq Parameters page**.
2. Set the **Start Step** as desired.

You can also modulate the Start Step in real-time; for more information, see “Start Step modulation” on page 157. Modulating the start step does not change the End Step.

Adjusting the sound of an individual step

You can make some basic adjustments to the sound of each step's Multisample, including changing its volume and pitch, making it play in reverse, and changing the sample start points.

You can also use the AMS Outputs to modulate other Program parameters outside of the Wave Sequence, such as Filter Frequency, Pan, and so on.

To edit steps:

1. Go to the **Step Parameters page**.

3. Set the **End Step** as desired.

The read-only **Length** parameter will show you the total number of steps between the two points.

Setting up the loop

Wave Sequences can loop, so that some or all of the steps are played repeatedly—like a drum loop, or a loop in a sequencer.

You can set the start and end of the loop separately from the start and end of the Wave Sequence itself. The loop can either play for as long as the note is played, or repeat a specified number of times. Finally, you can choose whether the loop plays forwards, plays backwards, or alternates between backwards and forwards.

To set up the loop:

1. Set the **Loop Start and End Steps** as desired.
2. Set the **Loop Direction**.

Forwards plays from the Start Step to the Loop End, and then skips back to the Loop Start.

Backwards/Forwards plays from the Start Step to the Loop End, then backwards from the Loop End to the Loop Start, and then forwards again to the Loop End, and so on.

Backwards plays from the Start Step to the Loop End, then backwards from the Loop End to the Loop Start, and then skips back to the Loop End, and so on.

3. Set the **Loop Repeats**.

You can set the loop to repeat a specific number of times, between 1 and 127. You can also make the loop keep playing for as long as the note is held (the **INF** setting), or not repeat at all (the **Off** setting).

This page shows the parameters for eight steps at a time. Use the scroll bar at the right of the screen to change which steps are in view.

2. In order for a step to make a sound, set its **Type** to **Multi (Multisample)**.
3. Select a **Multisample** using the **Bank and Multisample pop-up menus**.

Mono and stereo Multisamples are stored in different Banks. Each step can be either mono or stereo. Note that even if only one step uses a stereo Multisample,

the entire Wave Sequence becomes “stereo,” and uses twice as many voices - it’s the price that you pay for power!

4. Set the Level (volume) as desired.

This can be useful for evening out the perceived levels of different Multisamples, or for accenting steps in rhythmic sequences.

5. Set the Transpose and Tune as desired.

Transpose sets the Multisample’s coarse tuning, in semitones. You can use this to change the octave for individual steps, to create melodies, or to create interesting variations on percussion sounds by extreme transposition.

Tune controls the fine tuning, in cents (1/100 of a semitone). Small variations in tuning can create an interesting, organic feel.

6. Use Reverse and Start Offset to change the way that the Multisample plays.

Reverse plays the selected Multisample backwards, without looping. (If individual samples within the Multisample are already set to Reverse, they will still play in reverse, regardless of this setting.)

Start Offset lets you select from up to 8 pre-programmed sample start points (for ROM and EXs Multisamples), or between the normal start point and the loop start (for RAM Multisamples).

Using Insert/Cut/Copy/Paste

You can use the **Insert**, **Cut**, **Copy**, and **Paste** buttons to copy all of the parameters from one step to another, or to move a step to a different position in the sequence.

To insert a copy of a step into the sequence:

1. Select the step you’d like to copy.

You can do this by touching any of the step’s parameters, or by directly editing the Step parameter under the Wave Sequence graphic. The selected step is shown by a red arrow on the left side of the screen, as well as a red arrow in the graphic.

2. Press the Copy button.

You’re now ready to insert or paste the step.

3. Select the step which you’d like to follow the new step.

4. Press the Insert button.

The copied step is inserted at the selected position. The previously selected step, and all steps following it, move down to make room for the inserted step.

To remove a step from the sequence:

1. Select the step you’d like to remove.

2. Press the Cut button.

The selected step will be removed from the sequence, and all following steps will shift up to fill in the space.

Modulating Program parameters per step

Each step has two AMS Output values. These act kind of like step sequencers, allowing you to modulate any AMS destination in the Program. In other words, virtually any Program-level parameter can have a different setting for each step of the Wave Sequence.

For instance, to adjust the Filter Frequency separately for each step:

1. Select the Program that you’ll use for the Wave Sequence.

2. Go to the Filter Mod 1 tab of the Filter page.

This page has the filter modulation parameters for OSC1.

3. Under Filter A Modulation, set one of the AMS sources to Wave Seq AMS Out1.

	Alternate Modulation S	
Off	JS+Y	(CC)
AMS Mixer 1	JS-Y	(CC)
AMS Mixer 2	JS+Y & AT/2	
WavSEQ AMS Out1	JS-Y & AT/2	
WavSEQ AMS Out2	Foot Pedal	(CC)
Pitch EG	Ribbon	(CC)

4. Set the Intensity as desired.

This means that the AMS 1 output will modulate the Filter Frequency. Now, you just need to set up the Wave Sequence to send values out:

5. Go to the Wave Sequence Step Parameters page.

6. For each step, enter the desired value for AMS Out1.

7. Go to the OSC1 Basic tab of the OSC/Pitch page.

8. Set MS1 to use the Wave Sequence you edited in step 5.

The Filter Frequency will now change with every step.

You may wonder - what if the Program uses more than one Wave Sequence, and each is sending out different AMS values? Not to worry. Under the hood, each Wave Sequence actually has its own complete voice structure, which allows the AMS values to be different for each one.

Modulating individual steps with the AMS Mixer

You can combine the Wave Sequence AMS Outputs with the AMS Mixer to modulate individual steps. For instance, you can set up SW1 to mute a particular step. We’ll start by assuming that you have already set OSC1 to play the Wave Sequence. Then:

1. On the Wave Sequence Step Parameters page, set step 1’s AMS Out1 to 127.

2. Set AMS Out1 for all other steps to 0.

3. Go to the AMS Mix 1 tab of the AMS Mix/Common KTrack page.

4. On AMS Mixer 1, set the Type to Amt A x B.

5. For AMS A, select Wave Seq AMS Out 1.
6. Set the AMS A Amount to 00.
7. For AMS B, select SW 1 Mod (CC#80).
8. Set the AMS B Amount to +99.
9. Go to the Amp 1 Mod tab of the Amp/EQ page.

10. Under Amp Modulation, set the AMS source to AMS Mixer 1.
 11. Under the AMS source selection, set the Intensity to -99.
- SW1 will now mute and un-mute step 1. You can use this same technique for any per-step modulation.

Wave Sequence step Durations, Crossfade times, and Fade-In and Fade-Out shapes

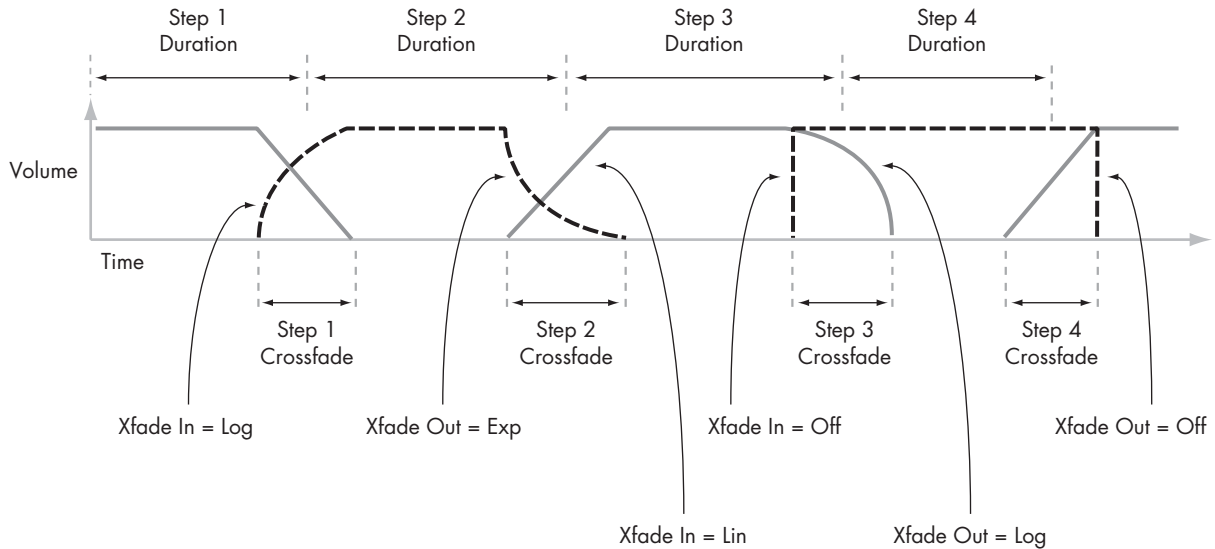

Using rhythmic Wave Sequences

Creating rhythmic Wave Sequences

To create a rhythmic Wave Sequence:

1. On the Seq Parameters page, set the Mode to **Tempo**.
This makes the Wave Sequence synchronize to the system tempo, as set by either the Tempo knob or MIDI Clock.
2. Set Run to On.
This is the default setting; the Wave Sequence will move from step to step automatically.
3. Select the Multisamples that you'd like to use, and set the Start, End, and Loop Start/End steps as desired.
4. Set the Loop Repeats to INF.
This will make the sequence repeat as long as you hold the note.
5. On the Step Parameters page, use the Base Note and Multiply ("x") parameters to set the rhythmic values for each step.
For instance, to create a dotted eighth note, set the Base Note to 1/16, and Multiply ("x") to 3.

6. Set the Step Xfade times to relatively short values, such as 0-5 ms.

This preserves the initial transients of the samples.

7. To create pauses in the rhythm, set the Step Type to Rest.

Doubling or halving the rhythmic pulse

You may sometimes want to slow down a 16th-note rhythm so that it becomes 8th-notes instead, or vice versa. The /2 and x2 buttons make this easy.

Press the /2 button to cut the **Base Note** and/or **Multiply** settings in half, so that 1/4 notes become 1/8 notes, 1/8 notes become 1/16 notes, and so on.

Press the x2 button to multiply the **Base Note** and/or **Multiply** settings by two, so that 1/8 notes become 1/4 notes, 1/4 notes become 1/2 notes, and so on.

Note: these buttons only appear when the **Mode** is set to **Tempo**.

Setting the tempo

Each Program, Combi, and Song has its own tempo setting. You can change the tempo simply by adjusting the front-panel TEMPO knob, or by tapping in quarter-notes on the TAP TEMPO button.

There's also a Global mode parameter which lets you switch between using the internal tempo or tempo from an external MIDI source (such as a computer-based sequencer). To sync to an external MIDI source:

1. Press the GLOBAL button to enter Global mode.
2. Select the MIDI tab.
3. Under MIDI Setup, set the MIDI Clock parameter as desired.

Internal uses the tempo stored with the Program, Combi, or Song, and set by the TEMPO knob.

External MIDI syncs to incoming MIDI clocks, and ignores the TEMPO knob.

Auto is a combination of the above. When clocks are received via MIDI, it syncs to the incoming clocks; when no clocks are being received, it defaults to the stored tempo settings.

Using Swing

Swing adds a human feel to the rhythm, and provides an easy way to turn a “square” rhythm into a shuffle groove.

This works by adjusting the position of the up-beats, relative to the Wave Sequence’s **Swing Resolution** setting. For instance, if the **Swing Resolution** is set to 1/8, **Swing** affects every other 8th note.

While the **Swing Resolution** is stored in the Wave Sequence, the **Swing** amount is set in the Program, Combi Timbre, or Song Track. This lets you use a single Wave Sequence in different Programs, Combis, and Songs, each with different amounts of swing.

For instance, to turn an 8th-note rhythm into a shuffle:

1. Create or select a Wave Sequence with an 8th-note rhythm.
2. On the Seq Parameters page, make sure that **Swing Resolution** is set to an 8th-note.
3. Create or select the Program in which you’d like to use the Wave Sequence.
4. Go to the OSC1 Basic tab of the OSC/Pitch page.
5. Set MS1 to use the Wave Sequence you selected in step 1.
6. Go to the Program Basic tab of the Basic/Vector page.
7. Under Wave Sequence, set the **Swing** parameter to +100%.

This makes the 8th-notes into a triplet, shuffle pattern.

Positive values make the up-beats later, and negative values make them earlier. When **Swing** is set to +300%, up-beats will be moved all the way to the next down-beat. At this point, the notes on the up-beats will not be heard at all.

If you are using the Wave Sequence in conjunction with KARMA, you may wish to adjust KARMA’s swing amount as well.

Swing with multiple Wave Sequences

If a Program contains multiple Wave Sequences with different **Swing Resolution** settings, the Program will use the finest value. For instance, if one Wave Sequence is set to 1/8 and the other is set to 1/16, the Program will use 1/16.

Wave Sequence Swing

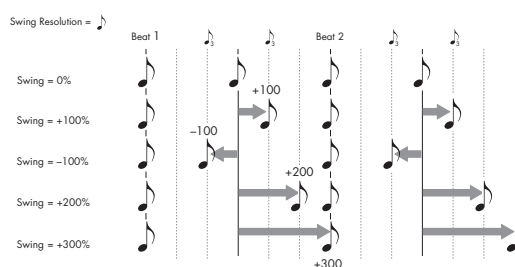

Keeping notes in sync

By default, the Wave Sequences for each note run independently from one another, so that each note sounds as an individual voice.

With rhythmic Wave Sequences, however, you may sometimes want all of the Wave Sequences in a chord to start together and sync together, in lock-step. OASYS gives you two tools to make this happen: **Key Sync Off**, and **Quantize Triggers**.

Key Sync Off

Each Program, each Combi Timbre, and each Track in a Song has its own **Key Sync** setting. The name “Key Sync” comes from the similar setting for LFOs, meaning “restart separately for each note-on.”

When **Key Sync** is **On**, each note’s Wave Sequence(s) will progress independently, so that each one can be on a different step, or moving at a different rate.

When **Key Sync** is **Off**, on the other hand, all of the Wave Sequences will be synchronized on the same step. There is one exception to this, however: if Duration is modulated with velocity or note-number, the Wave Sequences can still progress at different rates.

To turn **Key Sync Off** in a Program:

1. Go to the Program Basic tab of the Basic/Vector page.
2. Make sure that the **Key Sync** parameter is *not* checked.

To turn **Key Sync Off** in a Combi or Song:

1. Go to the Wave Sequence/KARMA tab of the Timbre Parameters page (for Combis), or Track Parameters page (for Songs).

Each of the 16 Timbres or Tracks has its own **Key Sync** parameter. If you like, you can set them all separately.

2. Set the **Key Sync** check-boxes as you like.

Remember, to synchronize all of the notes, turn **Key Sync off**.

Quantize Triggers

Quantize Triggers allows you to force most Tempo-mode Wave Sequence note-ons to be in sync, making it easier to play along with other rhythmic elements.

When **Quantize Trigger** is **On**, note-ons are quantized to 8th notes using the current tempo reference. (See below for a few more details.)

The tempo reference can come from different sources, depending on the current mode, and whether or not KARMA is on:

- In Program and Combi modes, if KARMA is off, note-ons are synchronized with the sounding Tempo-mode Wave Sequence, if any.
- In Program and Combi modes, if KARMA is on, note-ons are synchronized with KARMA.
- In Sequence mode during playback or recording, note-ons are synchronized with the sequence.
- In Sequence mode, while the sequencer is stopped, note-ons are synchronized with RPPR and KARMA.

Each Program, each Combi Timbre, and each Track in a Song has its own **Quantize Triggers** setting.

To turn on **Quantize Triggers** in a Program:

1. Go to the **Program Basic** tab of the **Basic/Vector** page.
2. Check the **Quantize Triggers** box.

To turn on **Quantize Triggers** in a Combi or Song:

1. Go to the **Wave Sequence/KARMA** tab of the **Timbre Parameters** page (for Combis), or **Track Parameters** page (for Songs).

Each of the 16 Timbres or Tracks has its own **Quantize Triggers** parameter. If you like, you can set them all separately.

2. Set the **Quantize Triggers** check-boxes as you like.

How Quantize Triggers works

The **Quantize Triggers** feature tries to make a good guess at where you intended the note to be. If you play the note just a bit late—within a 32nd note of the 8th note—it will assume that you meant the note to sound on the beat that just passed. In this case, the note will play immediately.

On the other hand, if you play the note up to three 32nd notes early, it will assume that you're intending the note to sound on the next beat. In this case, the note-on is delayed until the next 8th note.

Quantize Triggers

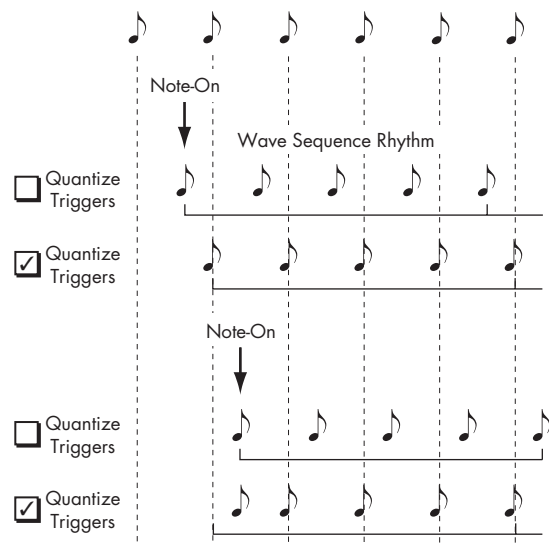

Creating smooth, evolving timbres

Crossfaded Wave Sequences

To create a smooth, crossfading Wave Sequence:

1. On the **Seq Parameters** page, set the **Mode** to **Time**.

This turns off tempo synchronization, so that you can set Wave Sequence durations in milliseconds.

2. Set **Run to On**.

This is the default setting; the Wave Sequence will move from step to step automatically.

3. Select the **Multisamples** that you'd like to use, and set the **Start**, **End**, and **loop** steps as desired.

4. On the **Step Parameters** page, set the **Durations** to relatively long values, 500ms or more.

5. Set the **Xfade** parameters to long values as well.

To crossfade continually, without pausing to hear a single step on its own, set the **Xfade** times the same as the **Durations**.

Note: In **Time** mode, the actual crossfade time cannot exceed the total duration of the two steps being crossfaded. If the **Xfade** setting would exceed this limit, the crossfade time will be clipped internally.

6. Adjust the **step Levels** to smooth out perceived volume differences between different **Multisamples**.
7. Adjust the **Fade-In** and **Fade-Out** shapes to taste.

The shapes can help you to fine-tune the transitions between the steps.

Stretching or compressing the sequence

If you like the proportions of the step durations and crossfades, but want the whole sequence to go faster or slower. The **Exp/Comp** (Expand/Compress) button makes this easy:

1. On the **Step Parameters** page, press the **Exp/Comp** button.

A dialog box will appear.

2. In the dialog box, set the **Expand/Compress %** parameter as desired.

100% means the current duration and crossfade times. Values 99 and below make the times shorter, and values 101 and above make them longer.

3. Press the **OK** button.

The step durations and crossfade times will be adjusted by the selected percentage.

Note: the **Exp/Comp** button appears only when the **Mode** is set to **Time**.

You can also stretch and compress Wave Sequences in real-time, via AMS. For more information, see “Duration modulation” on page 157.

Modulating Wave Sequences

Position modulation

Position modulation lets you offset the Wave Sequence from the current step. If **Run** is turned **On**, The Wave Sequence will continue to progress through its steps during modulation, kind of like fast-forwarding while playing a tape or CD.

To sweep through a sequence manually, creating the distinctive sound of a famous German synthesizer:

1. Set **Run** to **Off**.

This means that the Wave Sequence will stay on the current step, until you modulate the position.

2. Under **Modulation and Position**, select an **AMS** source, such as the ribbon or an EG.
3. Set the **Intensity** to a positive value to move forward through the steps, or a negative value to move backwards.

For instance, if **Intensity** is set to +14, the maximum amount of modulation will move 14 steps forward in the Wave Sequence.

Position modulation and loops

Position AMS affects only the current step, and does not change the loop start or loop end. This means that Position AMS can make the Wave Sequence jump into the middle of the loop, or jump back out of the loop again.

Duration modulation

Duration modulation lets you dynamically control the step duration and crossfade times. You can speed up or slow down the Wave Sequence so that it runs between 1% and 400% of the original rate.

By using **Velocity**, **key tracking**, or **note number** as the **AMS** source, you can make the Wave Sequences on every note have slightly different timing (or dramatically different timing, for that matter!) This can be very useful for making a cross-faded Wave Sequence sound more organic. For instance, to make the Wave Sequence move faster when you play at higher velocities:

1. Go to the **Sequence Parameters** page.
2. Under **Modulation and Duration**, select **Velocity** as the **AMS** source.
3. Set the **Intensity** to a value less than 100%, such as 90%.

Values below 100% make the durations shorter, so the Wave Sequence moves more quickly. Values above 100% make the durations longer, so the sequence moves more slowly.

Start Step modulation

You can use a MIDI controller, such as **Velocity**, to select a different start step for each note, to introduce more variety into the timbre. You can move the start step either forwards or backwards. For instance:

1. Make sure that **Note-On Advance** is **Off**.

When **Note-On Advance** is **On**, **Start Step** modulation is disabled.

2. Set the **Start Step** to 10, and the **End Step** to 25.
3. Set the **Loop Start** and **Loop End** to the same points –10 and 25.

The sequence will now loop through 16 steps, from 10 to 25.

4. Set the **Start Step AMS** (to the right of the **Start Step** parameter) to **Velocity**.
5. Set the **Intensity** to –9.

Playing at the highest velocities will now start the sequence at step 1 (moving it forward by 9 steps); at the lowest velocities, the sequence will still start at step 10.

In general, negative modulation moves the **Start Step** earlier in the sequence, to the limit of Step 1. Positive modulation moves the **Start Step** later in the sequence, to the limit of the **End Step**.

Note-On Advance

This feature lets you advance the start point of the Wave Sequence by one step with each new note-on. If **Loop Repeats** is not set to **Off**, **Note-On Advance** will step through the loop, paying attention to the loop direction and number of repeats.

For instance, let’s say that the Wave Sequence **Start Step** is 2, and the **End Step** is 6. Also, the **Loop Start** is set to 3, the **Loop End** is set to 5, and the **Loop Direction** is set to **Forward**.

If **Repeat Times** is **Off**, **Note-On Advance** will make the Wave Sequence play as follows:

1st note: 2, 3, 4, 5, 6

2nd note: 3, 4, 5, 6

3rd note: 4, 5, 6

4th note: 5, 6

5th note: 6

6th note: 2, 3, 4, 5, 6

7th note: 3, 4, 5, 6

8th note: 4, 5, 6

9th note: 5, 6

10th note: 6

11th note: 2, 3, 4, 5, 6

etc...

If **Repeat Times** is **1**, **Note-On Advance** will make the Wave Sequence play as follows:

first note: 2, 3, 4, 5, 3, 4, 5, 6

2nd note: 3, 4, 5, 3, 4, 5, 6

3rd note: 4, 5, 3, 4, 5, 6

4th note: 5, 3, 4, 5, 6

5th note: 3, 4, 5, 6

6th note: 4, 5, 6

7th note: 5, 6

8th note: 6

9th note: 2, 3, 4, 5, 3, 4, 5, 6

10th note: 3, 4, 5, 3, 4, 5, 6

11th note: 4, 5, 3, 4, 5, 6

12th note: 5, 3, 4, 5, 6

13th note: 3, 4, 5, 6

14th note: 4, 5, 6

15th note: 5, 6

etc...

Finally, if **Repeat Times** is **INF**, **Note-On Advance** will make the Wave Sequence play as follows. Note that the Wave Sequence never returns to the start step, since it's outside of the loop:

first note: 2, 3, 4, 5, 3, 4, 5, 3, 4, 5, 3, 4, 5...

2nd note: 3, 4, 5, 3, 4, 5, 3, 4, 5, 3, 4, 5...

3rd note: 4, 5, 3, 4, 5, 3, 4, 5, 3, 4, 5...

4th note: 5, 3, 4, 5, 3, 4, 5, 3, 4, 5...

5th note: 3, 4, 5, 3, 4, 5, 3, 4, 5...

6th note: 4, 5, 3, 4, 5, 3, 4, 5...

7th note: 5, 3, 4, 5, 3, 4, 5...

8th note: 3, 4, 5, 3, 4, 5...

9th note: 4, 5, 3, 4, 5, 3, 4, 5...

10th note: 5, 3, 4, 5, 3, 4, 5...

etc...

Note-On Advance and Key Sync

Note-On Advance is also affected by the setting of the **Key Sync** parameter.

If **Key Sync** is **On**, the start point will advance by one step for each note.

If **Key Sync** is **Off**, the start point will advance by one step for each new phrase. For more information, see "Key Sync" on page 665 of the Parameter Guide.

Saving Wave Sequences

Once you've spent all this time editing, you'll want to save your work. To save your Wave Sequence edits:

1. **Select the Write Wave Sequence command from the page menu, at the upper right-hand corner of the screen.**

This brings up a dialog box which allows you to save the Wave Sequence. Optionally, you can also select a new location, or change the Wave Sequence's name.

2. **Press the "T" button to bring up the text edit dialog.**

You can give the Wave Sequence a descriptive name using the on-screen keyboard.

3. **After entering the name, press OK.**

The text edit window will disappear, returning you to the main Save dialog.

4. **Press the popup button next to WaveSeq to bring up the save location dialog.**

5. **Select a location to save the edited Wave Sequence.**

To avoid overwriting the factory sounds, it's safer to use a slot in one of the seven User banks.

6. **After selecting the location, press OK.**

7. **Press OK again to start the write process.**

8. **If you're sure you want to write to this location, press OK again.**

After that, you're done!

Using Drum Kits

Drum Kit Overview

What's a Drum Kit?

Drum Kits, as the name implies, are optimized for creating drum sounds. They offer a number of special features, such as:

- Each note can play a different sound
- Instead of selecting Multisamples (which span the entire keyboard), you can select Drum Samples (which contain a single drum sound). These can be from the ROM, RAM, or EXs banks.
- On each note, you can use up to four Drum Samples, with velocity crossfades
- Each note has separate settings for the most important sound parameters, including volume, filter cutoff and resonance, envelope attack and decay, pitch, drive and low boost, and gain for each band of the Program EQ.
For instance, you could combine high drive and low cutoff frequency to create a lo-fi effect on only a few sounds, while the rest of the sounds remained clear and pristine.
- Each note can be routed to different Insert Effects, or have separate FX Send amounts. For instance, you can send a snare sound through a dedicated compressor.

You can use Drum Kits only in Programs whose **Oscillator Mode** is set to **Drums**.

Drum Kit memory structure

The OASYS has 161 Drum Kits, divided into Internal, User, and GM (General MIDI) groups as shown below. You can edit or write into any of the locations except for the GM bank, which cannot be erased.

For details on the factory-programmed Drum Kits, please see the Voice Name List.

Drum Kit banks

Bank	Drum Kit No.	Contents
INT	00...39	Factory Drum Kits
USER A...G	00...31	User (initialized) Drum Kits
GM	0...8	GM2 Drum Kits

The 9 Drum Kits in the GM bank are compatible with the GM2 sound map. The other Drum Kits may use different mappings, where appropriate.

Drum Kit Programs and Oscillator Mode

The Program's **Oscillator Mode** setting, on the Program Basic tab of the Basic/Vector page, sets whether the Program is used to play Drum Kits or to play normal Multisamples (such as pianos, strings, etc.).

You'll see the results of this setting on the OSC1/Basic tab of the OSC/Pitch page. If the **Oscillator Mode** is set to **Single** or **Double**, you can select up to four Multisamples for each Oscillator, with velocity switches or crossfades.

If the **Oscillator Mode** is set to **Drums**, you'll be able to select a single Drum Kit. There are still four levels of velocity switches and layers - but these are within the Drum Kit itself, and not stored or edited in the Program.

Before you start editing...

First, select a Drum Program

Drum Kits are edited in Global Mode. While you're in Global Mode, you'll play the kit that you're editing as if you were playing it from within the Program, Combi, or Song which was selected before you entered Global mode.

So, before you enter Global mode, it's best to select a Program which is already set up for drums, with the appropriate EG settings, effects, and so on. Just use the Program Category select popup, and choose a drum Program such as "Standard Kit."

OSC1/Basic Octave setting

In order for the note mappings to match the keyboard, the Oscillator's **Octave** setting needs to be **+0 [8']**. All Drum Kit Programs should have this setting already. If you're unsure, you can check this yourself:

1. Go to the OSC1/Basic tab of the OSC/Pitch page.
2. Check that the Octave parameter (near the top of the page) is set to **+0 [8']**.

With a setting other than **+0 [8']**, the relationship between the keys and the Drum Kit sound map will be incorrect.

Make sure that Memory Protect is disabled

Before you start editing, go to the Global Basic page, and look in the Memory Protect section. Make sure that **Drum Kit** is not checked—if so, you won't be able to make any edits.

Drum Kits may be used by more than one Program

When you edit a Drum Kit, all Programs that use that Drum Kit will be affected. To avoid changing the factory voicing, you may wish to copy Drum Kits to empty locations in the USER banks before editing.

Editing Drum Kits

Basic Editing

1. **Select the Program that you wish to use while editing the Drum Kit.**

For more information, see “First, select a Drum Program,” above.

2. **Press the front-panel GLOBAL button to enter Global mode.**
3. **Go to the Sample Setup tab of the Drum Kit page.**
4. **Use the Drum Kit parameter, at the top of the screen, to select the Drum Kit that you wish to edit.**

You can save this to a different memory location after editing, if you like.

5. **Use the Key parameter to select the note that you wish to edit.**

To select a key, you can use any of the standard VALUE controllers (the slider, dial, numeric keypad etc.). As a shortcut, you can also hold down the ENTER key and play a note on the keyboard.

This Key selection applies to all three Drum Kit editing tabs.

6. **Use the Assign check box to specify whether the key will have its own settings, or use the same settings as the next higher note.**

If **Assign is checked**, the key will have its own settings. This is the default.

If **Assign is not checked**, the key won't have its own settings. Instead, it will use the same settings as the next higher note—except that the drum samples will be played at a lower pitch. The amount of pitch change depends on the **Pitch Slope** parameter, on the **OSC1 Pitch** tab of the **OSC/Pitch** page.

Use this setting when you want only to change the pitch, such as with tom or cymbal sounds.

Creating a velocity crossfade

For this key, let's create a simple velocity crossfade between two stereo drum samples.

1. **On the left side of the screen, make sure that DS1 and DS2 are turned On.**

Just press the On/Off buttons to toggle them, if necessary.

2. **Similarly, make sure that DS3 and DS4 are turned Off.**

When they are turned off, most of their parameters will be grayed out.

3. **Select ROM Stereo as the Bank for DS1 and DS2.**

There are three main types of Drum Sample Banks: **ROM**, **RAM**, and **EXs**. For each type, you can also choose between looking at mono and stereo Drum Samples. Note that stereo Drum Samples will require twice as many voices as mono Drum Samples.

ROM Drum Samples are the built-in “factory” sounds, and are always available. These are organized by category, such as bass drums, snares, hats, etc.

RAM Drum Samples include Akai, AIFF or WAV files loaded from disk, and samples created in Sampling mode.

EXs Drum Sample banks are PCM expansion sets created especially for the OASYS. Each has its own unique number; for instance, the ROM Expansion is EXs1, and the Concert Grand Piano expansion is EXs2. Only the currently loaded EXs banks will appear on this menu.

4. **Press the Drum Sample popup for DS1.**

This brings up a list of Drum Samples, organized by category. Use the tabs at the left of the screen to browse through the different categories.

For a list of the Drum Sample names, please see the Voice Name List.

5. **Select a Drum Sample by touching its name in the list.**
6. **Press the OK button to confirm your selection.**
7. **Do the same for DS2.**

Now that you've assigned Drum Samples to DS1 and DS2, let's set up the velocity ranges and crossfades.

8. **Set DS2's Bottom Velocity to 001, and its Xfade Range to 0.**
9. **Set DS1's Bottom Velocity to 80.**

Now, DS2 will sound when you play softly, at velocities of 79 or less—and DS1 will sound when you play harder, with velocities of 80 or more.

You can also see this split visually, in the graphic on the right side of the LCD.

10. **Next, set DS1's Xfade Range to 20, and its Curve to Linear.**

Notice that the graphic now shows the two ranges tapering into one another. Between 80 and 100, DS2 will fade out, and DS1 will fade in, creating a gradual velocity transition instead of a hard split.

Fine-tuning the sound of each sample

1. **If you like, adjust the Levels for the two Drum Samples.**

This can be very useful in creating a smooth velocity split or crossfade.

2. Set the tuning and EG parameters as desired.

For each Drum Sample, you can control offsets to the Program's settings for transposition, tuning, and EG attack and decay times.

3. Go to the Sample Parameter tab.

This page lets you make even more adjustments to the sound. For each Drum Sample, can control offsets to the Program's settings for filter cutoff and resonance, drive, and low boost. Additionally, you can control the gain for each band of the EQ.

For more information, please see "Global P5: Drum Kit" on page 673 of the Parameter Guide.

4. Repeat steps 1–3 to set up each key of the Drum Kit.

You can also copy settings from one key to another, using the Copy Key Setup menu command.

Using Exclusive Groups

1. Select the Voice/Mixer tab.
2. Use the Exclusive Groups to make one drum sound cut off another drum sound - such as closed and open hi-hats.

For example, let's say that you've assigned an open hi-hat and a closed hi-hat to the same exclusive group:

- Play the open hi-hat sound.
- While it's still ringing, play the closed hi-hat.
- The open hi-hat sound will be cut off—simulating the action of a physical hi-hat.

Using Hold

The Program **Hold** parameter can be especially useful for drum programs, since it lets the samples ring out naturally regardless of how long you hold down the note. The way that this works depends on settings in both the Program and the Drum Kit, as described below.

To enable **Hold**:

1. In Program mode, go to the Program Basic tab of the Basic/Vector page.
2. Under Key Zone, make sure that the Hold check-box is checked.

Once you've turned on **Hold** for the Program, the function is controlled on a note-by-note basis according to settings within the Drum Kit.

3. In Global mode, go to the Voice Mixer tab of the Drum Kit page.

Saving Drum Kits

Once you've spent all this time editing, you'll want to save your work. To save your Drum Kit edits:

1. Select the Write Drum Kit command from the page menu, at the upper right-hand corner of the screen.

4. For each key, set the Enable Note Off Receive parameter as desired.

If this parameter is *unchecked*, the key will be held.

If it is checked, the key will not be held.

If you turn off **Hold** in the Program, no keys will be held - regardless of their **Enable Note Off Receive** setting.

Controlling effects for each key

Drum Kits have their own, built-in mixers. For each key, you can control the Insert Effects bussing, Master Effects sends, and pan.

To use separate bus settings for each key:

1. In Program mode, go to the Routing tab of the IFX page.
2. Make sure that the Use DKit Setting check-box is checked.

When Use DKit Setting is on, the Program will use the Bus Select and Effects Send settings for each key of the Drum Kit.

When Use DKit Setting is off, the Program will ignore the Drum Kit's Bus Select and Effects Send settings.

3. In Global mode, go to the Voice Mixer tab of the Drum Kit page.
4. Use the Bus Select (IFX/Indiv. Out Assign) parameter to send drum sounds through their own Insert effects, or to the individual outputs.

If you like, you can send each note to its own Insert effect, or to the individual audio outputs, in addition to the main L/R outputs.

For example, you might send all snare sounds to IFX1, all kick sounds to IFX2, and the remaining sounds to L/R.

5. Use "Send1(MFX1)" and "Send2(MFX2)" to set the send levels to the master effects.

Controlling pan for each key

To use separate pan settings for each key:

1. In Program mode, go to the Amp1/Driver1 tab of the Amp/EQ page.
2. Under Pan, make sure that the Use DKit Setting check-box is checked.

When Use DKit Setting is on, the Program will use the pan settings for each key of the Drum Kit.

3. In Global mode, go to the Voice Mixer tab of the Drum Kit page.
4. Use the Pan parameter to specify the key's stereo output position.

This brings up a dialog box which allows you to save the Drum Kit. Optionally, you can also select a new location, or change the Drum Kit's name.

2. Press the "T" button to bring up the text edit dialog.

You can give the Drum Kit a descriptive name using the on-screen keyboard.

3. After entering the name, press OK.

The text edit window will disappear, returning you to the main Save dialog.

4. Press the popup button next to Drum Kit to bring up the save location dialog.

5. Select a location to save the edited Drum Kit.

To avoid overwriting the factory sounds, it's safer to use a slot in one of the seven USER banks.

Note that although you can edit General MIDI kits, you can only save these edits to locations in the INT or USER banks. The original GM kits cannot be overwritten.

6. After selecting the location, press OK.

7. Press OK again to start the write process.

8. If you're sure you want to write to this location, press OK again.

After that, you're done!

Loading & saving data, and creating CDs

Saving data

Types of data that can be saved

There are three ways to save data; you can write it into internal memory, save it to media (internal hard disk, internal CD-R/RW, or a USB-connected hard disk, CD-R/RW, or removable disk), or transmit it as a MIDI data dump. You can also use WAVE files to create an audio CD that can be played by CD players.

Writing to internal memory

The following types of data can be written into the internal memory.

- **Program**
Programs 000–127 in banks INT-A...F, USER-A...G
- **Combination**
Combinations 000–127 in banks INT-A...G, USER-A...G
- **Global settings**
(Global P0: Basic–P3: Category Name)
- **User wave sequence patterns**
Banks INT: 000...149, Banks USER-A...G: 00...31
- **User drum kits**
Banks INT: 00...39, Banks USER-A...G: 00...15
- **User template songs U00–U15**
Song settings such as the song name and tempo, track settings, KARMA, and effect settings can be saved (written) to internal memory. However, the musical data for song tracks and patterns are not saved to internal memory. Furthermore, settings that govern how the musical data is played back such as “Meter,” “Metronome,” “PLAY/MUTE,” “Track Play Loop (including Start/End measure),” and RPPR settings will not be saved either. Use the Sequencer mode page menu command “Save Template Song” to write this data; for more information, see “Save Template Song” on page 525 of the Parameter Guide.

 RAM Multisamples and Samples must be saved to and loaded from disk; they cannot be written into internal memory.

This means that if you turn the power off and then on once again, but do not re-load the necessary RAM Multisamples or Samples, any data that uses such multisamples or samples will not sound as intended. This can include Combinations, Programs, Drum Kits, Wave Sequences, and Multisamples.

 Data that you edit in Sequencer or Sampling mode can only be saved to disk; it cannot be saved in internal memory.

Saving to disk, CDs, and USB media

The following data can be saved to various types of media.

- **.PCG file:**
Programs, combinations, global settings, drum kits, and wave sequences (The data that was checked in the check boxes of the Save dialog box will be saved.)
- **.SNG file:**
Song and region data.
- **.KSC, .KMP, .KSF files:**
Lists of sample and multisamples (.KSC file), multisamples (.KMP file), samples (.KSF file).
- **.KFX file:**
Effect preset data.
- **.MID file:**
Saves a Sequencer mode song in Standard MIDI File (SMF) format.
- **.EXL file:**
System exclusive data from an external device that was saved on the OASYS (This allows the OASYS to be used as a data filer.)
- **.WAV and .AIF files:**
A sample you recorded can be exported (written) as a WAVE file or AIFF file.
- **.KCD file:**
These are track lists for audio CDs.

MIDI data dump

The following types of data can be transmitted as a MIDI data dump and saved on an external data filer or other device.

- **Programs, combinations, global settings, drum kits, and wave sequences**
- **Songs**

For more information, see “Dump Program” on page 685 of the Parameter Guide.

About preloaded data and preset data

“Preloaded data” refers to the data that is loaded in the OASYS when it is shipped from the factory. You are free to rewrite this data, and with the exception of the demo songs, the data will be written to the location listed in “Writing to internal memory.” All of this data is stored in the internal hard disk.

- Program banks INT-A, B, C, D, E (HD-1 program): 000–127, INT-F, USER-F (EXi program): 000–127
- Combination banks INT-A, B, C: 000–127
- Drum kit banks INT: 00–39

- Wave sequence banks INT: 000–149
- Demo songs

Preset data is data that cannot be rewritten by the Write operation. This includes the following data.

- Program banks G, g(1)–g(9), g(d): 001–128
- Preset drum kits 144 (GM)–152 (GM)
- Preset template songs P00–P15
- Preset patterns P000–P149

Writing to internal memory

Writing a program or combination

The program and combination settings you’ve edited in the various editing pages can be saved to internal memory. This action is referred to as “writing a program” or “writing a combination.” If you want your edited data to be preserved after the power is turned off, you must write it.

There are two ways to write a program or combination.

- ⚠ Before you write data into memory, you must turn off the memory protect setting in Global mode. (See “Memory protect” on page 167)
- ⚠ A combination does not contain the actual program data for each timbre, but simply remembers the number of the program used by each timbre. If you edit a program that is used by a combination, or exchange it with a different program number, the sound of the combination will also change.

Editing using the Tone Adjust function

There are three types of Tone Adjust parameters.

- **Absolute:** This type of Tone Adjust parameter controls a single program parameter. The program parameter and the Tone Adjust parameter reflect each other exactly. If you edit one, the other parameter will reflect the identical change. This type of Tone Adjust parameter “absolutely” controls the program parameter itself.
- **Relative:** This type of Tone Adjust parameter controls two or more program parameters simultaneously. For example, “Filter/Amp EG Attack Time” controls a total of six program parameters. The value of a relative parameter indicates the amount of change that is applied to the value of each program parameter it’s affecting. When a relative parameter is at zero (i.e., when its knob or slider is in the center position), the program parameters it controls will function according to their original settings. Raising or lowering the value of a relative parameter will indirectly raise or lower the value of these program parameters.
- **Meta:** This type of Tone Adjust parameter affects other Tone Adjust parameters. It does not affect program parameters directly.

If you’ve adjusted an absolute or a relative Tone Adjust parameter, the result of your adjustment will be written as follows.

Program mode:

- The settings of relative-type Tone Adjust parameters are automatically applied to the program parameters when you write the program. The Tone Adjust values will be reset to zero.

- The settings of absolute-type Tone Adjust parameters are written “as themselves” (i.e., as the settings of those Tone Adjust parameters).

Combination mode:

- The settings of both relative-type and absolute-type Tone Adjust parameters are written and preserved as the Tone Adjust settings for each timbre.

Using the Write menu command

1. Select the page menu command “Write Program” or “Write Combination.”

The Write Program/Write Combination dialog box will appear.

Note: You can also access the same dialog box by holding down the ENTER switch and pressing the 0 switch. (See “Shortcuts” on page 182.)

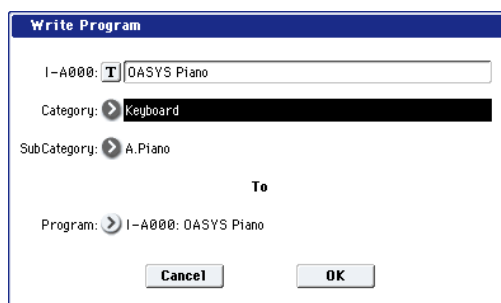

The screen shown is for Program mode

2. Check the program/combination name displayed in the upper line (the writing source).
3. If you wish to change the name of the program/combination, press the text edit button.

The text dialog box will appear. Enter the name of the program/combination. See “Editing names” on page 166.

After you have entered the name, press the OK button to return to the Write Program/Write Combination dialog box.

4. In “Category,” specify the category of the Program/Combination.
5. Select a “Sub Category” as well.

For combinations, the category and sub-category you specify here can be selected in the following screen pages.

Combination P0: Play– Prog Select/Mixer
“Category” (Category/Combination Select)

For programs, the category/sub-category you specify here can be selected in the following screen pages.

Program P0: Play
“Category” (Category/Program Select)

Combination P0: Play– Prog Select/Mixer
 “Category” (Category/Program Select)

Sequencer P0: Play/REC– MIDI Track Prog Select/
 Mixer “Category” (Category/Program Select)

6. Use “To” to specify the bank and number of the writing destination program/combination.

Use the VALUE controllers or the BANK switches to make your selection.

7. To execute the Write operation, press the OK button. To cancel without executing press the Cancel button.

When you press the OK button, the display will ask “Are you sure?” When you press the OK button once again, the data will be written.

Using the (SEQUENCER) REC/WRITE switch to write

This method can only be used to write the selected program/combination number.

1. Press the SEQUENCER REC/WRITE switch.

The following Update Program/Update Combination dialog box will appear.

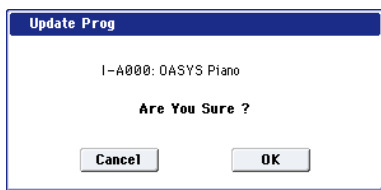

The screen shown is for Program mode

2. To write the data, press the OK button. To cancel without writing, press the Cancel button.

Writing Drum Kits and Wave Sequences

Here’s how a drum kit or wave sequence you’ve edited in Global mode can be written into the internal memory of the OASYS.

⚠ The Wave Sequence “Tempo,” “Key Sync,” “Swing,” and “Quantize Trigger” settings are stored with each program, combination, or song. These parameters are not saved by writing the wave sequence as described here. If you’ve moved from Program or Combination mode and edited these parameters, return to the previous mode and write your edits.

Using the page menu Write command

1. Press the page menu button, and press “Write Drum Kit” or “Write Wave Sequence” in the menu.

The Write Drum Kit/Write Wave Sequence dialog box will appear.

Note: You can get the same dialog box by holding down the ENTER switch and pressing the 0 switch. (See “Shortcuts” on page 182)

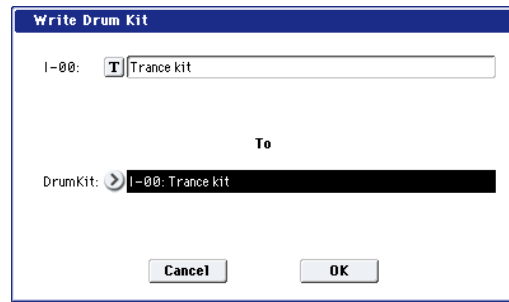

The screen shown is for Drum Kit

2. Verify the name of the write-source drum kit or wave sequence shown in the upper line.

3. If you want to edit the name of the drum kit or wave sequence, press the text edit button.

The text edit dialog box will appear. Input the desired name for the drum kit or wave sequence. (See “Editing names” on page 166)

When you’ve input the name, press the OK button to return to the Write Drum Kit/Write Wave Sequence dialog box.

4. Use the “To” field to specify the bank and number of the write-destination drum kit or wave sequence.

Use the VALUE controller or BANK switches to specify the desired setting.

5. To write the data, press the OK button. If you decide not to write, press the Cancel button.

When you press the OK button, the display will ask “Are you sure?” Press the OK button once again to write the data.

Using the (SEQUENCER) REC/WRITE switch to write

You can use this method to write the selected drum kit or wave sequence.

1. Press the SEQUENCER REC/WRITE switch.

The Update Drum Kit/Update Wave Sequence dialog box will appear.



The screen shown is for Drum Kit

2. To write the data, press the OK button. If you decide not to write, press the Cancel button.

About the Edit Buffer

When you select a program, combination, wave sequence, or drum kit in Program P0: Play, Combination P0: Play, Global P4: Wave Sequencer, or Global P5: Drum Kit respectively, the data is called into the edit buffer of the OASYS.

When you then use the various Program or Combination pages or Global mode P4/P5 pages to edit the parameters, your changes will affect the data in the edit buffer.

If you wish to save this modified data into internal memory, you must perform the Write operation.

When you perform the Write operation, the data in the edit buffer is written to the specified program, combination, wave sequence, or drum kit number of the specified bank.

If you select another program, combination, wave sequence, or drum kit without writing, the data of the newly selected program or combination will be called into the edit buffer, and your changes will be lost.

Note: When you press the COMPARE switch in Program mode, Combination mode, or Global mode P4, P5 page, the data from memory (i.e., the contents that were written into memory) will be temporarily called into the edit buffer. This allows you to compare the settings you are editing with the original un-edited settings.

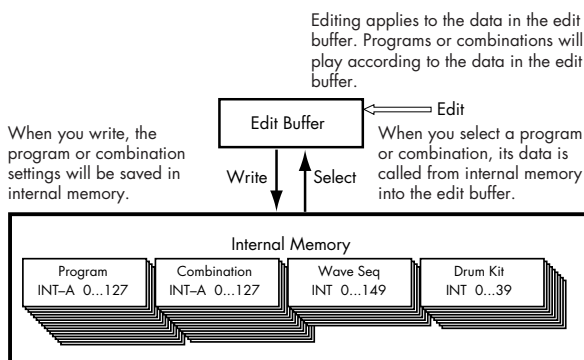

Editing names

You can modify the name of an edited program, combination, song, drum kit, wave sequence, multisample or sample etc.

You can also modify the category names for programs and combinations.

These renaming operations can be performed in the following pages.

Program	Program P0...9 page menu command: Write Program
Combination	Combination P0...9 page menu command: Write Combination
Wave Sequence	Global P4 page menu command: Write Wave Sequence
Drum Kit	Global P5 page menu command: Write Drum Kit
Song	Sequencer P0, 1, 2, 3 page menu command: Rename Song
Region	P4: Track Edit- Edit Region
Track	Sequencer P4: Track Name
Pattern	Sequencer P5: Pattern Name
Multisample	Sampling P0...4 page menu command: Rename MS
Sample	Sampling P0...4 page menu command: Rename Sample
Program category/ sub category	Global P3: Program Category
Combination category/ sub category	Global P3: Combination Category
KARMA GE category/ sub category	Global P3: GE Category
File	Disk Save: Save All...Save Audio CD Track List, Disk Utility page menu command: Rename

As an example, here's how to write a Program or Combination using the Write page menu command, and entering "OASYS-Program01" in step 3.

1. Press the text edit button **T** to open the text edit dialog box. (See the following diagram)
2. Press the Clear button.

Press the Shift button to switch to uppercase characters, and press OASYS-P.

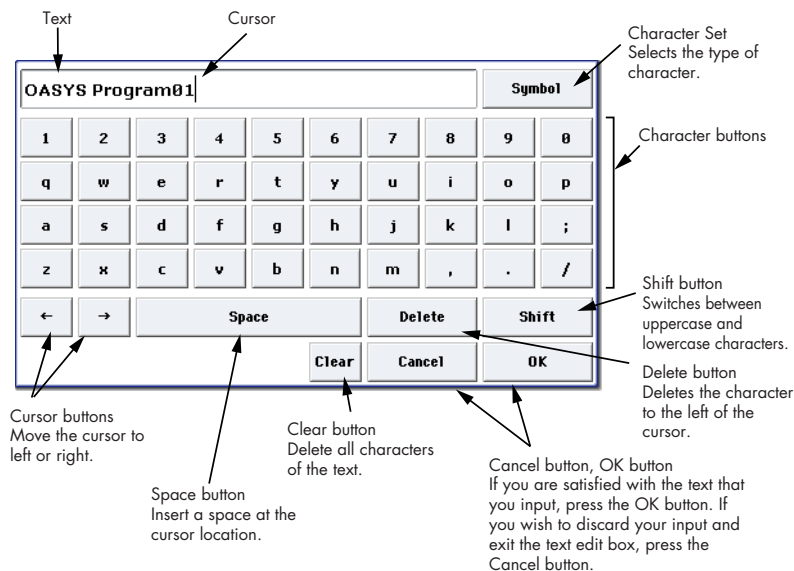

Press the Shift button once again to switch to lowercase characters, and press the characters r, o, g, r, a, m, 0, 1.

3. Press the OK button to close the dialog box.

If you don't need to make any corrections, press the OK button to close Write Program.

Memory protect

To prevent programs, combinations, songs, drum kits, wave sequences, and KARMA GE from being overwritten accidentally, the OASYS provides a Memory Protect setting that prohibits writing to memory.

Before you save edited data or load data from media, use the following procedure to turn the memory protect off (uncheck the appropriate check box).

You must also turn memory protect off before loading the above data from media or via a MIDI data dump, or before recording in Sequencer mode.

1. Press the GLOBAL switch to enter Global mode.
2. Access the Global P0: Basic Setup– Basic page, and select the Basic page.

Press the Basic tab at the bottom, and then press the Basic tab above it.

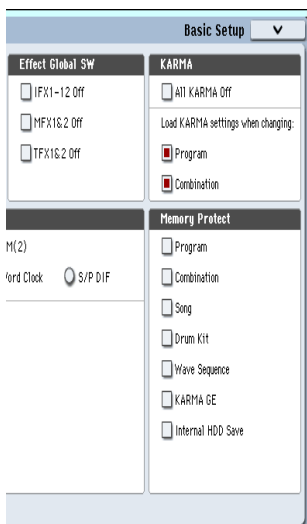

3. Press the “Memory Protect” check box for the type of data you wish to write to internal memory, so that the box is unchecked.

Writing global settings

The settings you edit in Global mode P0–P3 can be written into internal memory as Global settings. If you wish to use these edited settings after you turn the power off, be sure to write the data first.

The wave sequences and drum kits you edit in Global mode P4 and P5 must be written as individual wave sequences and drum kits.

There are two ways to write global settings.

Using a page menu command to write

1. To write global settings (the various settings in Global P0–P3), press the page menu command Write Global Setting in Global P0–P3.

The Write Global Setting dialog box will appear.

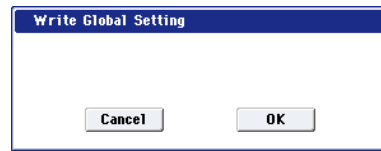

Note: The same dialog box will also appear if, in each of the above pages, you hold down the ENTER switch and press the 0 switch. (See “Shortcuts” on page 182)

2. To execute the Write operation, press the OK button. To cancel, press the Cancel button.

When you press the OK button, the display will ask “Are you sure?” Press the OK button once again to write the data.

Using the (SEQUENCER) REC/WRITE switch to write

1. In the Global P0–P3 pages, press the SEQUENCER REC/WRITE switch.

A dialog box will appear.



2. To execute the Write operation, press the OK button. To cancel, press the Cancel button.

Memory in Global mode P0–P3

When the power is turned on, the Global mode P0–P3 data is called from internal memory into the Global mode memory area. Then when you modify the parameters in Global mode, the data in the memory area will be modified. If you wish to save this modified data in internal memory, you must Write it. When you write this data, the data in the memory area is written into the global settings. If you turn off the power without writing, the modified data in the memory area will be lost.

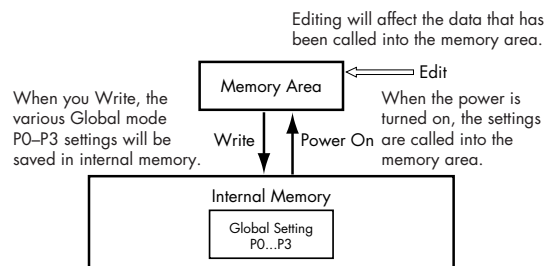

Saving to disks, CDs, and USB media

For details on the data that can be saved on storage media. (See “Types of data that can be saved” on page 163.)

-  Song data and region data in the OASYS’s Sequencer mode, as well as multisamples and samples cannot be written into internal memory. This data will disappear when the power is turned off. In order to keep this data, you must write it to the internal hard disk, to CD media in the internal CD-R/RW drive, or to an external USB storage media (hard disks, flash media, etc. When you’ve come up with settings you like, it’s a good idea to save them, so that even if you subsequently edit those settings, you’ll always be able to reload the previous settings if desired.

Types of media you can use

Internal hard disk

The internal hard disk uses the Linux Ext3 format.

Internal CD-R/RW drive

OASYS supports three CD-R/RW formats: UDF, CD-DA (audio CDs) and ISO9660 (level 1).

Standard saving and loading from the CD-R/RW drive uses the UDF format, which allows you to treat CDs much as you would a hard drive. For more information, see “CD-R/RW disks on the OASYS: UDF and packet-writing” on page 1033 of the Parameter Guide.

You can load data from ISO9660 (level1) discs, but OASYS does not write directly to ISO9660 format. You can, however, convert a UDF-formatted CD-R/RW to ISO9660 format, for easier loading on other systems. For more information, see “Convert to ISO9660 Format” on page 723 of the Parameter Guide.

Finally, you can sample audio from CD-DA (audio CD) discs, and can also record your own music to audio CDs. For more information, see “Ripping – P5: Audio CD” on page 139, and “Creating audio CDs” on page 175.

External USB storage media

- Hard disks**
- Removable disks**
 Hard disks and removable disks in MS-DOS format FAT16 or FAT32 are supported.
Capacity recognized:
 FAT32: up to 2 terabytes = 2,000 Gigabytes (GB)
 FAT16: up to 4 GB
- CD-R/RW**
 With external USB CD-R/RW devices, you can use the same formats as with the Internal CD-R/RW drive, as described above.
- Floppy disks**
 MS-DOS format 3.5 inch 2HD and 2DD floppy disks can be used. The formatted capacity of the floppy disks will be 1.44 MB (18 sectors/track) for 2HD, and 720 KB (9 sectors/track) for 2DD.

-  These types of media are not included. You will need to purchase them separately.

Media setup

This section explains how to make the OASYS recognize media so that data can be saved on it.

Setup for saving data on the internal hard disk

- Press the MODE DISK switch to enter Disk mode.
- Use Drive Select to select HDD: INTERNAL HD.

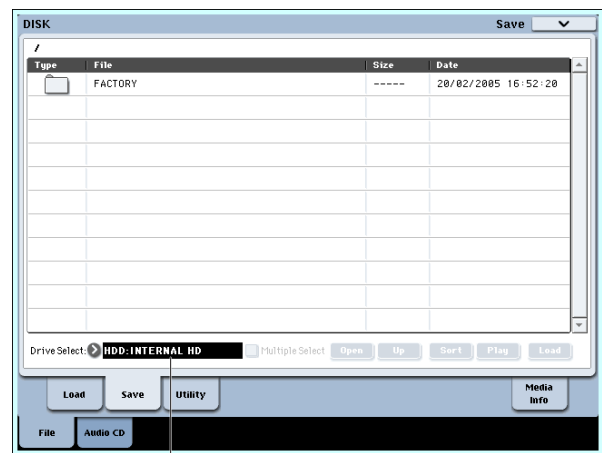

Drive Select

Setup for saving data on CD-R/RW media in the internal CD-R/RW drive

- Insert CD-R/RW media in the drive. Be sure to read “CD-R/RW handling” on page iv for details on proper handling procedures.
- In order to save data on a disc, you’ll need to format it first. For more information, see “Formatting media” on page 170.
- Press the MODE DISK switch to enter Disk mode.
- Use Drive Select to select CDD.

Setup for using a USB device

- Use a USB cable to connect the USB 2.0 connector of the OASYS to the USB connector of your USB device (hard disk, removable disk, CD-R/RW).

Note: The OASYS’s USB 2.0 connectors support hot-plugging; you can connect or disconnect the USB cable while the power is on. However in order to do so, your USB device must also support hot-plugging.

- Turn on the power.
- If you are using a USB hard disk, removable disk, or CD-R/RW drive, turn on the power of your USB device and use a USB cable to connect it to the OASYS’s USB 2.0 connector.

Note: The above step assumes that your USB device supports hot-plugging. If you are using a device that does not support hot-plugging, connect it with the power turned off. Then turn on the power.

-  While the OASYS is accessing the USB device, do not connect another USB device or disconnect the connected device. Doing so may damage your data.

4. Press the MODE DISK switch to enter Disk mode.
5. Press the Media Info tab, and then execute the page menu command "Scan device."
6. Use Drive Select to select your media.

If you are using a removable disk, insert the media. After you exchange media in your USB device, press the LCD screen to make the OASYS detect the media. When the media has been detected, the LCD screen will display information about the media.

7. If the media needs to be formatted, execute the Format operation.

Media requiring formatting is indicated as Unformatted in Drive Select. For more information, see "Formatting media" on page 170.

How to save data

You can save the various types of data listed in "Types of data that can be saved" on page 163, but as an example here we'll explain how to save the following:

- Internal memory programs, combinations, global settings, drum kits, and wave sequences
- Songs
- Multisamples and samples created in Sampling mode etc.

 If you save this data to low-capacity media, you may need more than one disk.

1. Prepare the media on which you want to save the data. (See "Media setup" on page 168)
2. Press the MODE DISK switch to enter Disk mode.
3. Select the Disk-Save page. Press the File tab, and then the Save tab.
4. Press Drive Select to select the save-destination drive.
5. If the media contains directories, select the directory in which you want to save the data.

Press the Open button to move to a lower level, or press the Up button to move to an upper level.

Note: If you are saving data on high-capacity media, we recommend that you create directories to organize the media into sections.

To create a new directory, move to the level at which you want to create the directory, and execute the Utility page menu command "Create Directory."

6. Press the page menu button to access the page menu, and press Save All.

Save All will save .PCG, .SNG, and .KSC files.

A dialog box will appear. The contents, settings, and operations for the dialog box will depend on the type of data that you are saving.

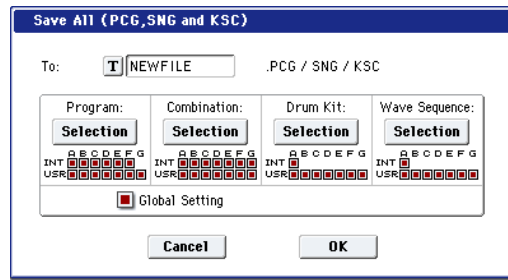

7. Press the text edit button and input a filename for the file you want to save. (See p.166)
8. Press each Selection button to access the dialog box, and use the check boxes to uncheck any items that you do not need to save.

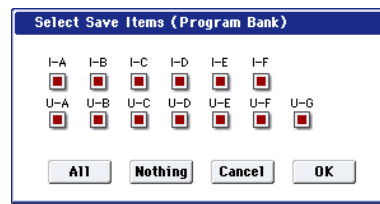

In order to accurately reproduce the data you created, we recommend that you check all of the boxes.

9. Press the OK button to execute the Save operation.

If the data fits on one volume of media

The data will be saved on the specified media, and you will return to the Save page.

If the data does not fit on one volume of media

The "No space available on medium" dialog box will appear.

Press the OK button and the file will be divided and saved to multiple volumes of media. If you don't want to divide the file, press the Cancel button, and re-save it to larger-capacity media.

For more information, see "Save All (PCG, SNG and KSC)" on page 717 of the Parameter Guide.

10. When saving ends and you return to the Save page, the LCD screen will show the file that was saved.

The various types of data are saved as the following files.

.PCG file: This contains all of the Programs, Combinations, Drum kits, Wave Sequences, and global settings from the internal memory.

.SNG file: This contains all of the Songs from Sequencer mode.

Note: If the audio tracks contain recorded data, region data will also be saved at this time. The WAVE files and a directory named with the first six characters of the .SNG filename plus "_A" appended will be copied to the directory that contains the .SNG file.

.KSC file: This lists all of the RAM multisamples and samples in internal memory.

Directory: A directory containing the multisamples (.KMP files) and samples (.KSF files) that are listed in the .KSC file.

The data will be saved to the media, and you will return to the Save page.

The amount of time required will depend on the amount of data being saved.

If a file with the same name already exists on the media, you will be asked whether you want to overwrite. If you wish to overwrite, press the OK button. If you wish to save without overwriting, press the Cancel button, re-do the operation from step 6, and rename the data in step 7 before saving it.

Note: When using **Save All**, “Save PCG & SNG,” and **Save PCG** to save combinations, you should also remember to save the programs used by each timbre (or the drum kits, and wave sequences used by the programs) at the same time.

Similarly when saving programs, you should also remember to save the drum kits and wave sequences used by the programs.

Note: If your programs or drum kits use multisamples and samples that were created in on OASYS, we recommend that you use **Save All** to save the data.

When you use **Save PCG** or “Save Sampling Data” to individually save a program or drum kit, or a multisample or sample that you created, we recommend that you save them under the same filename in the same directory. When you use “Load PCG” to load a .PCG file, the identically-named .KSC file will also be loaded so that the correct multisamples/samples will correspond automatically.

Using the OASYS as a data filer

The OASYS can receive MIDI System Exclusive data sent by an external device, and save this data to media. (This is sometimes referred to as “Data Filer” functionality.) For more information, see “Save Exclusive” on page 720 of the Parameter Guide)

Formatting media

Newly purchased media or media that has been used by another device cannot be used “as is;” you must format the media before you can use it with the OASYS.

- The OASYS is shipped with the internal hard disk already formatted.
- When creating audio CDs, you don’t need to format the CD-R/RW media.

 When you format, all data saved on that media will be erased. If you had used a computer etc. to set up that drive so that it can be used as multiple drives (partitions), this data will also be erased. Be sure to double-check before you format.

 After formatting, it is not possible to press the COMPARE switch to return to the previous state.

1. **Make sure that the media you want to format is inserted.**
(See “Media setup” on page 168)
2. **Press the MODE DISK switch to enter Disk mode.**
3. **Select the Disk-Utility page. Press the File tab, and then the Utility tab.**
4. **Press Drive Select, and choose the drive that you want to format.**

5. **Press the page menu button to access the page menu, and press “Format” to open the dialog box.**

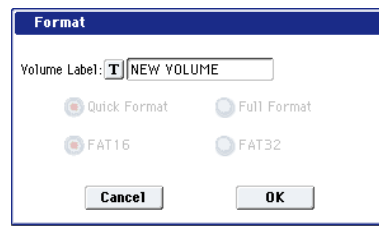

6. **In “Volume Label,” use the text edit button to access the text edit dialog box, and specify the volume label.**

The previously-specified volume label will be displayed. If no volume label had been specified for the media, or if a non-DOS media was inserted, this will indicate “NEW VOLUME.”

7. **Specify the initialization format.**

Quick Format: Normally you should use Quick Format to initialize the media.

Select this if the media has already been physically formatted, or if you want to format media that has been UDF-formatted by the OASYS. Since only the system area of the media need be formatted, this will require less time.

Note: For the internal hard disk you can only select “Quick Format.”

Full Format: Select this when formatting media that has not been physically formatted, or media (CD-RW) that has not been UDF-formatted.

Note: Normally, it is not necessary to perform a Full Format on media that has been physically formatted at 512 bytes/block. Execute the Quick Format for such media.

Note: You will normally select Full Format for CD-RW media etc. that has not been UDF-formatted. If an error message of “Media not formatted” appears, execute Full Format.

Depending on the capacity of the media, executing Full Format may require a substantial length of time.

8. **Specify the file system.**

Use FAT16 to format media of 4 GB or less (such as flash media), and use FAT32 to format larger media (theoretically, up to 2 Terabytes).

9. **Press the OK button to format, or press the Cancel button if you decide to cancel.**

When you press the OK button, a message will ask you for confirmation. Press the OK button once again to execute the Format operation.

 You must format a CD-R/RW disc if you want to use it for packet writing, or if it has previously been used by another device.

You do not need to format a CD-R/RW disc that you will use to create an audio CD.

 You must use the OASYS to format the media. The OASYS will not correctly recognize media that has been formatted by another device.

Loading data from disk

The types of data that can be loaded from media are shown in the diagram “Supported file types” on page 172. (For more details, see “Load selected” on page 703 of the Parameter Guide)

The Disk mode Load page lets you load data from the internal hard drive, the internal CD-RW drive, or any USB 2.0 Mass Storage Device, such as hard drives, flash media, etc.

Loading .PCG, .SNG, and .KSC files

As an example here, we will explain how to load a song. We’ll assume that this song uses edited programs and programs that use multisamples you sampled. In such cases, it is best to load “all data.”

 When loading programs, combinations, songs, drum kits, or wave sequences, you must make sure that the Global mode memory protect setting is unchecked. (See “Memory protect” on page 167)

1. Make sure that the media is ready for you to load data. (See “Media setup” on page 168)
2. Press the MODE DISK switch to enter Disk mode.
3. Select the Disk–Load page. Press the File tab, and then the Load tab.

Press **Drive Select** and select the media from which you want to load.

4. Navigate to the directory that contains the file you want to load, and select the .SNG file.

Press the Open button to move to a lower level, or press the Up button to move to a higher level.

The selected .SNG file will be highlighted.

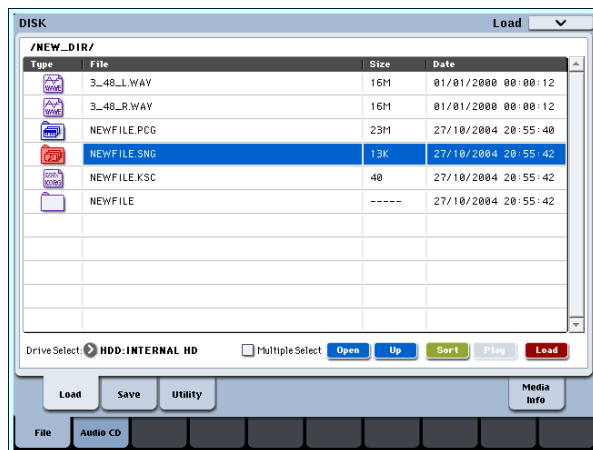

5. Press the page menu button to access the page menu, and choose “Load Selected.”

A dialog box will appear.

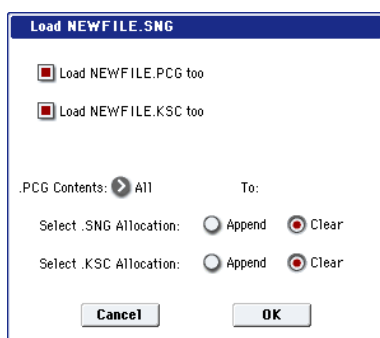

Note: The contents and settings of the dialog box will differ depending on the type of file that you are loading.

6. Check the “Load *****.PCG too” check box.

When you execute loading, the .PCG file will be loaded along with the .SNG file.

Check the “Load *****.KSC too” check box.

When you execute loading, the .KSC file will be loaded along with the .SNG file.

Use “.PCG Contents” to specify the data that you want to load.

If you want to load all the data in the .PCG file, select All.

Use “Select .SNG Allocation” to specify the destination to which the song data will be loaded.

“Append” will load the song into the song number that follows the song(s) currently existing in internal memory, without leaving a vacant number.

“Clear” will erase all songs from internal memory, and load the songs into the numbers from which they were saved.

Use “Select .KSC Allocation” to specify where the multisamples and samples will be loaded.

“Append” will load the data into the next available vacant numbers following the multisamples and samples that are already in sample memory (RAM).

“Clear” will erase all multisamples and samples from sample memory (RAM), and load the data in the same configuration with which it was saved.

7. Press the OK button to execute loading.

 Never remove the media while data is being loaded.

Loading multiple files at once

You can use “wild cards” to specify multiple .KMP, .KSF, .AIF, .WAV, AKAI Program, and AKAI Sample files, and load them simultaneously. For more information, see “Loading multiple files at once” on page 711 of the Parameter Guide.

Supported file types

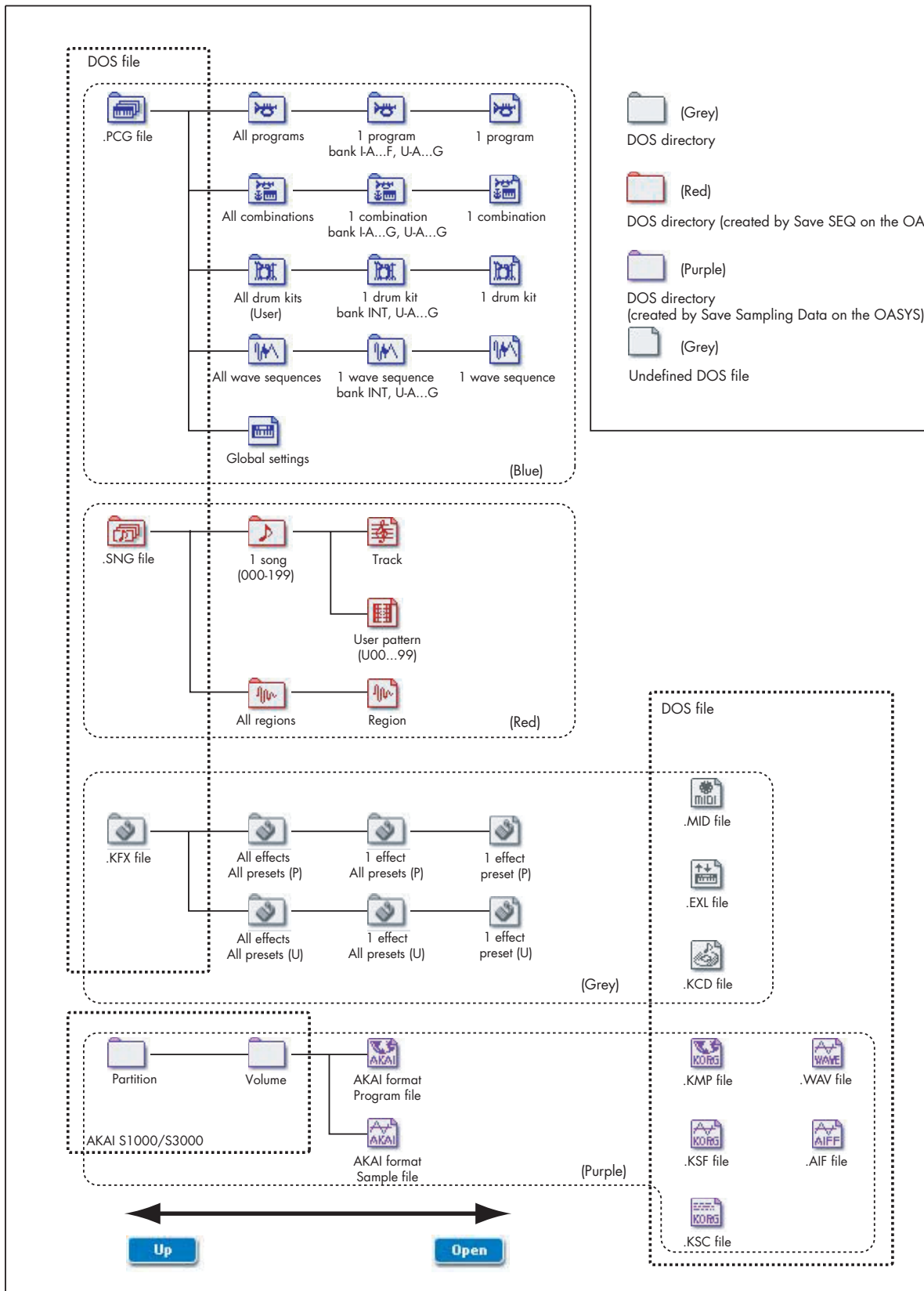

Loading individual banks from a .PCG file

1. Select the .PCG file containing the data you want to load, and choose the page menu command "Load Selected."

Refer to steps 1–4 of "Loading .PCG, .SNG, and .KSC files" on page 171." Select the .PCG file in step 5.

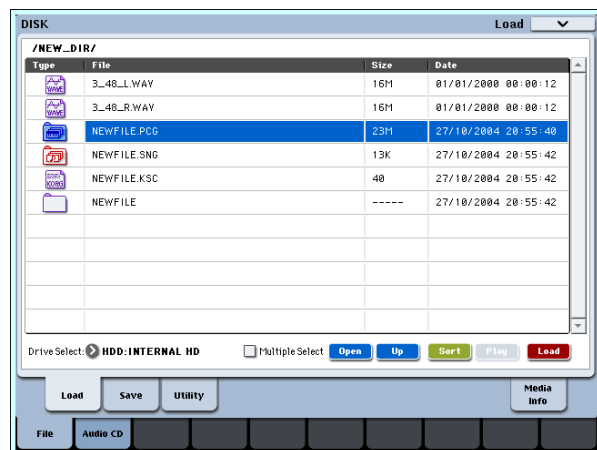

2. Press the page menu button to open the page menu, and choose "Load Selected."

You can load individual banks by using ".PCG Contents" in the dialog box to select the load-source bank, and "To" to select the load-destination bank.

When you execute loading, only the programs, combinations, drum kits, and wave sequence data of the selected bank will be loaded into the load-destination bank you specify. Global setting data will not be loaded.

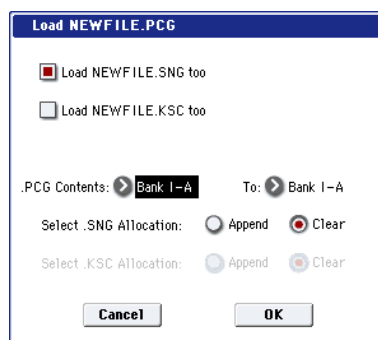

If you set ".PCG Contents" to Bank INT-A, and "To" to Bank INT-A, data will be loaded as follows.

Programs

- Bank INT-A: loaded into Bank INT-A

Combinations

- Bank INT-A: loaded into Bank INT-A

Drum Kits

- INT: loaded into Bank INT

Wave Sequences

- INT: loaded into Bank INT

When data is loaded into a bank that is different than its original bank, the data (bank, program, pattern, and kit numbers, etc.) will automatically be reconfigured so that after loading, the various types of data will correspond correctly in each mode.

The following data will also be reconfigured automatically if you have checked "Load .SNG too" (so that song data is loaded at the same time), the following data will also be reconfigured automatically in order to ensure that the song data plays back correctly.

- The bank of each program used by combinations
- The bank of each drum kit and wave sequence used by each program
- The bank of the program used by each track of the song
- If the song contains track/pattern events, the program banks within these events

Loading data by individual item or bank

The OASYS lets you load programs, combinations, drum kits, and wave sequences individually or by individual banks.

This is a convenient way to rearrange combinations in the order in which you will use them during a live performance.

- ⚠ Be aware that if you change the order of programs, the sounds played by combinations may also be affected.

As an example here, we will explain how a combination saved in bank INT-D can be loaded into INT-E000.

1. Move to the "Bank INT-D" directory, and select the combination that you want to load. (.PCG

file/Combinations/Bank INT-D/)

The procedure is as follows.

- 1) Perform steps 1–5 under "Loading .PCG, .SNG, and .KSC files" on page 171. Select the .PCG file containing the data you want to load (it will be highlighted), and press the Open button.
- 2) Press "Combinations" to highlight it, and press the Open button.
- 3) Press "Bank D" to highlight it, and press the Open button.
- 4) Press the scroll bar to find the combination you want to load, and highlight it in the display.

Alternatively, you could select any file, since the desired file can be selected later from the dialog box.

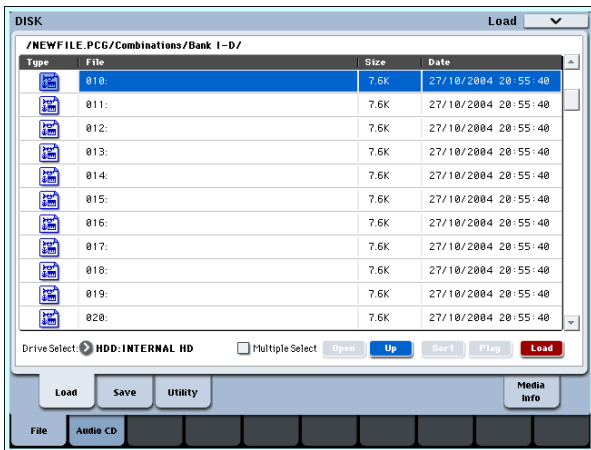

Note: When you press the keyboard of the OASYS, the selected combination will sound. However, the internal programs will be used as the program of each timbre.

2. Press the page menu button and select the "Load Selected" page menu command.

The dialog box will appear.

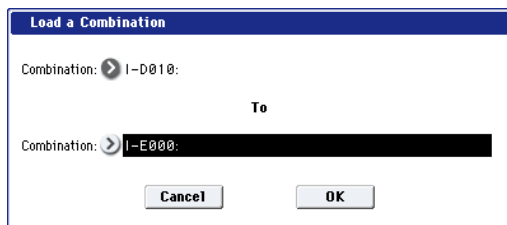

3. Use the "Combination" (upper line) to select the load-source combination, and use "(To) Combination" (lower line) to specify the destination combination. For this example, select INT-E000.

As shipped from the factory, this Combi location is empty; it has no name, and makes no sound.

4. Press the OK button to execute loading; the loaded combination will be assigned to INT-E000.

Creating and playing audio CDs

WAVE files you create by resampling to the internal hard disk or to an external USB hard disk in Sequencer mode etc. can be arranged in a desired order and used to create an audio CD.

- Make sure that both media are detected by the OASYS.

- When writing data to CD-R/RW media, the media containing the Wave files must have free space equal in size to the Wave files you are writing. Before you execute this operation, make sure that the drive containing the Wave files contains enough free space.

Creating audio CDs

Part 1: Bouncing to disk

If you're starting with Songs you've created in Sequencer mode, you'll first need to bounce the Songs to WAVE files on the internal hard drive.

- In Sequencer mode, select the first song that you want to burn to the CD.
- Go to the 0-8: Audio In/Sampling page.
- Select **Bounce All Tracks To Disk** from the menu. A dialog box will appear, showing the file system.
- Use **Drive Select**, **Open**, and **Up** to select the directory in which the WAVE file will be saved.
- Use **Name** to specify the filename for the WAVE file.
- Press the **OK** button to execute the command. If you decide to cancel, press the **Cancel** button.

The Song will start playing. Recording will begin and end automatically, and the resulting stereo WAVE file will be saved to the disk.

Repeat the steps above for all of the Songs that you'd like to burn to the CD, and then proceed to Part 2 below.

Part 2: Making the CD

- Go to the **Disk- Make Audio CD** page.

Press the **Audio CD** tab, and then the **Make Audio CD** tab.

In the default state, the WAVE File area will show only "====End====."

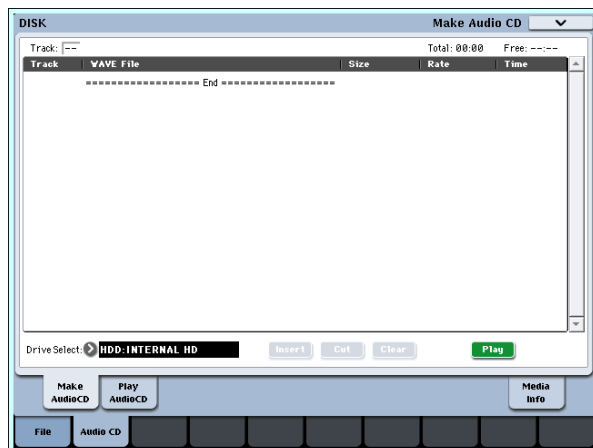

- To the track list, add the WAVE files that you want to write to the CD.

Select "====End====" (it will be highlighted), and press the **Insert** button.

The **Insert Track** dialog box will appear.

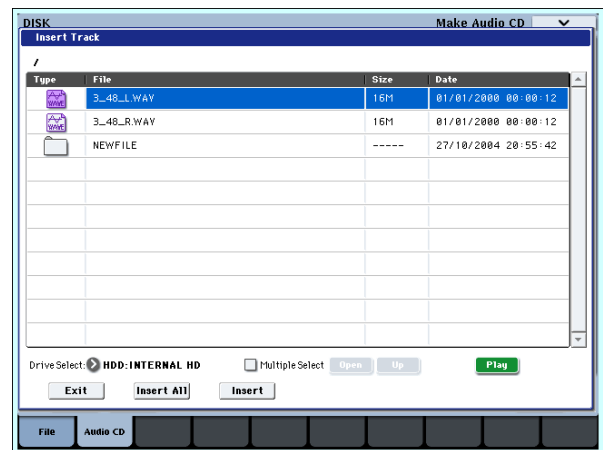

Use media select and the **Open** and **Up** buttons to access the directory that contains the WAVE file, and select the WAVE file that you want to add to the list.

You can press the **Play** button to play back the sample for auditioning. Alternatively, you can press the **SAMPLING START/STOP** switch to play it.

- If you have selected a WAVE file with a sampling frequency other than 48 kHz, it will not be possible to press the **Play** button.
- If you have selected a WAVE file with a sampling frequency other than 44.1 kHz or 48 kHz, it will not be possible to press the **Insert** button.
- WAVE files at a sampling frequency of 48 kHz will be converted to 44.1 kHz when they are written to an audio CD (when you execute "Write to CD").

To add the file, press the **Insert** button.

You can continue adding files until you press the **Exit** button. The files will be added to the track list in the order in which you selected them. If you want to add all the WAVE files in the directory, press the **Insert All** button.

Note: If you check the "Multiple Select" option, you'll be able to select multiple WAVE files and insert them in a single operation.

When you have finished adding files to the list, press the **Exit** button to close the dialog box.

Notice that the WAVE files have been added to the track list.

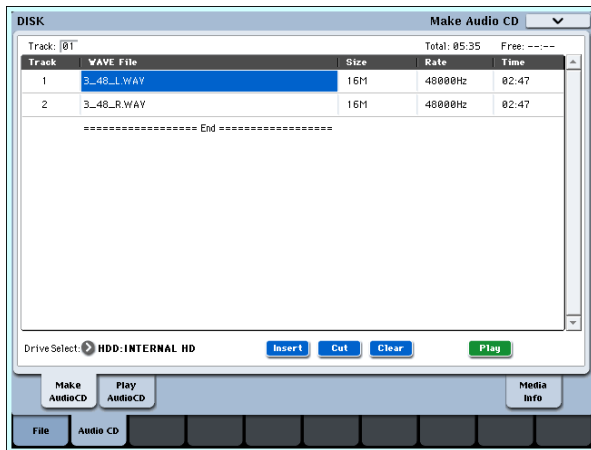

If you select a WAVE file in this page whose sampling frequency is 48 kHz, you can also use the Play button to play the sample.

To add other WAVE files to the track list, press the Insert button once again.

If you want to add another track, select the WAVE file that follows the track you want to add. If you want to add the track to the end of the track list, select “====End====.” Then press the Insert button.

To delete a WAVE file from the track list, select the WAVE file that you want to delete, and press the Cut button. Subsequent tracks will be moved forward in the list.

Note: For more details on other editing operations, please see “1-1c: Drive Select, Command buttons” on page 699 of the Parameter Guide, and “Swap Track” on page 724 of the Parameter Guide.

3. Insert a blank CD-R or CD-RW disk into the drive.

In the Make Audio CD page, use **Drive Select** to select the internal CD-R/RW drive or an external USB CD-R/RW drive. The CD-R/RW drive is shown as “CDD: Blank Disc.”

- ⚠ An audio CD cannot be created on a disc that contains data other than audio (e.g., files). In this case, it will not be possible to select the page menu commands “Write to CD” or “Finalize Audio CD.”

Note: Even when the recommended CD-R/RW media is used, some audio CD players may be unable to play back the disc. Also, since some audio CD players are unable to play back CD-RW media, we recommend that you use CD-R media.

4. Select the page menu command “Write to CD” to access the dialog box, and specify how the CD will be written.

Use **Speed** to set the writing speed. This will indicate the speeds supported by the CD-R/RW drive you are using. In this example, set **Speed** to 1x.

- ⚠ Be aware that if you use a faster writing speed in a slower system, writing errors will occur.

Use “Mode” to specify the writing method.

Note: Depending on the drive you are using, it may not be possible to write at the specified speed. We recommend that the first time you write, you select Test to perform a writing test in order to determine the speed capabilities of your drive. Test will not write

data to the CD-R/RW media, but will perform all other processing just as when data is actually written. If an error occurs, the display will indicate “Error in writing to medium.”

Press the OK button to execute the writing test.

After verifying that data can be written correctly at the specified speed, select Write.

“Execute finalize too” specifies whether Finalization will be executed after the audio tracks have been written to the CD-R/RW media. If finalization has been executed, the disc can be played back on a CD player, but it will no longer be possible to add more tracks.

Note: If you only want to execute finalization, execute “Finalize Audio CD.”

5. When you are ready to write to the CD-R/RW media, or to execute a writing test, press the OK button. To cancel without executing, press the Cancel button.

- ⚠ When you press the OK button, the “Obey Copyright Rules” dialog box will appear.
- 6. Carefully read **COPYRIGHT WARNING** on v, and if you consent to the terms, press the OK button to begin burning the CD. If you do not consent to the terms, press the Cancel button to cancel the operation.
- ⚠ In order to avoid causing errors, do not subject the drive to physical shock or vibration while CD-R/RW media is being written.

Saving Track Lists

The track list will be lost when the power is turned off. If you want to keep this data, you must save it.

1. In the Save page, select the directory in which you want to save the track list.
2. Select the page menu command “Save Audio CD Track List” to open the dialog box.
3. Press the OK button to save the data, or press the Cancel button to cancel without saving.

Playing audio CDs

You can play audio CDs—including CDs you've created—directly on the OASYS.

To do so:

1. Press the Play Audio CD tab to go to the Play Audio CD page.

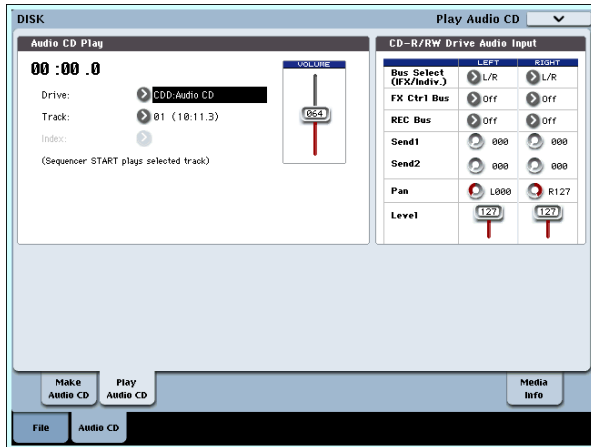

2. In Drive Select, select your CD-R/RW drive. Drive Select will indicate Audio CD.
3. To allow monitoring, set the CD-R/RW Drive Audio Input as follows.
 LEFT: Bus (IFX/Indiv.) L/R, FX Ctrl Bus Off, REC Bus Off, Send1/Send2 000, Pan L000, Level 127
 RIGHT: Bus (IFX/Indiv.) L/R, FX Ctrl Bus Off, REC Bus Off, Send1/Send2 000, Pan R127, Level 127
 Volume: 127
4. Use Track to select the track, and press the SEQUENCER START/STOP switch to begin playback.

Other disk operations

Viewing information about media – Disk Media Info

This displays information about the media selected in “Drive Select.”

Mounting USB storage devices

Use the Disk Media Info page menu command **Scan device** to mount a device connected via USB 2.0. For more information, see “Scan device” on page 724 of the Parameter Guide.

Setting the date and time

OASYS has an internal calendar, which is used to record the date and time when you save data. You can set the date and time by using the Disk Utility page’s “Set Date/Time” menu command.

You will need make these settings after you purchase the OASYS, and after you replace the calendar backup battery.

1. Press the **MODE DISK** switch to enter **Disk mode**.
2. Select the **Disk-Utility** page. Press the **File** tab, and then the **Utility** tab.
3. Open the page menu, and select the **Set Date/Time** command.

The following dialog box will appear.

4. Use the **VALUE** controllers to set the correct year, month, day, hour, minute, and second.
5. Press the **OK** button.

- ⚠ If the calendar backup battery runs low, a message of “Battery voltage for calendar IC” will appear in the LCD screen. If the calendar backup battery runs down completely, the calendar will be initialized, and the date and time will not be recorded correctly.

Note: You can replace the calendar backup battery by yourself. For more information, see “Installing the calendar battery” on page 1040 of the Parameter Guide.

Restoring the factory settings

Restoring EXs samples to the factory defaults

When the OASYS is shipped from the factory, the PCM memory bank is set to load the EXs1 ROM Expansion sample library at start-up. For more information, see “About the OASYS’ PCM memory” on page 31.

1. Press the **MODE GLOBAL** switch to enter **Global mode**.
2. Press the **EXIT** switch to access the **P0: Basic Setup** page.
3. Press the page menu button located in the upper right of the LCD, and select “Expansion Sample Setup.”

A dialog box will appear.

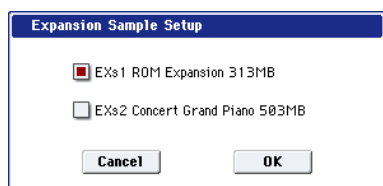

4. Select the desired EXs PCM bank.

If you check “EXs1 ROM Expansion 313 MB,” the multisamples and samples for EXs1 will be loaded at start-up.

5. Press the **OK** button.

The following message will appear:

The Expansion Sample Setup has now been changed. In order for your changes to take effect, please turn the power off, and then on again.

[OK]

This completes Expansion Sample Setup settings. When you power-cycle the OASYS, the specified PCM bank will stand-by.

6. Press the **OK** button.
7. Turn off the power.

The PCM bank you specified will be loaded and available the next time you turn on the power.

Wait approximately ten seconds before you turn the power on.

- ⚠ Data you created or edited will be lost when you turn off the power, so be sure to back up your data before you turn off the power.

- ⚠ After you turn off the power, wait approximately ten seconds before you turn the power on.

Restoring program, combination, drum kit, wave sequence, and global settings to their factory-set condition

This section explains how to restore these settings to their factory-set condition. This is done by loading the PRELOAD.PCG file (provided on the included CD and on the internal hard disk). Here we will explain the method of loading the PRELOAD.PCG file from the included CD.

- ⚠ Before you load this data, you must access the Global mode P0: Basic Setup– Basic page, and uncheck the “Memory Protect” setting for the data you are going to load. If you execute this operation with this setting checked, a message of “Memory Protected” will appear, and the data will not be loaded.
- ⚠ When you load a .PCG file, the internal memory of the OASYS will be overwritten by the data of the .PCG file (programs, combinations, drum kits, wave sequences, and global settings). If you want to keep the contents of internal memory, you must use **Save All** or **Save PCG** to save your data before you execute the following procedure.

1. Insert the included CD “Restore 1/4” into the OASYS’s CD-R/RW drive.
2. Press the MODE DISK switch to enter Disk mode, and press the LCD screen to make the OASYS recognize the disc.

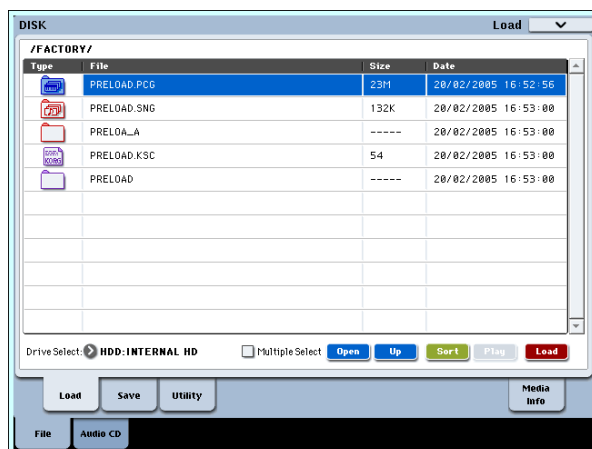

3. Press the File tab and then the Load tab to select the Disk– Load page.

The LCD screen will show the file information.

4. Use Drive Select to select CDD.
 5. Select the PRELOAD.PCG file.
- The selected file will be highlighted.
6. Select the page menu command “Load selected.”

The following dialog box will appear.

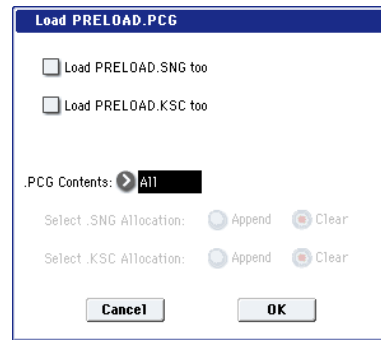

The displayed dialog box and the settings will depend on the type of file you’re loading.

7. Use “.PCG Contents” to specify the data you want to load. To completely restore the factory voicing, use the All setting.

If you use the All setting to load PRELOAD.PCG from the included CD, all data of the .PCG file will be loaded as follows.

Programs

- Bank INT-A file: loaded into Bank INT-A (HD-1)
- Bank INT-B file: loaded into Bank INT-B (HD-1)
- Bank INT-C file: loaded into Bank INT-C (HD-1)
- Bank INT-D file: loaded into Bank INT-D (HD-1)
- Bank INT-E file: loaded into Bank INT-E (HD-1)
- Bank INT-F file: loaded into Bank INT-F (EXi)
- Bank USER-A file: loaded into Bank USER-A (HD-1)
- Bank USER-F file: loaded into Bank USER-F (EXi)

Combinations

- Bank INT-A file: loaded into Bank INT-A
- Bank INT-B file: loaded into Bank INT-B
- Bank INT-C file: loaded into Bank INT-C

Drum Kits (40 Drum Kits)

- Bank INT file: loaded into Bank INT

Wave Sequences (150 Wave Sequences)

- Bank INT file: loaded into Bank INT

8. Press the OK button to load the data.

- ⚠ Never attempt to remove the media while data is being loaded.

Other functions

Assigning functions to SW1/2 and the REALTIME KNOBS

Setting the functions of SW1 and SW2

SW1 and SW2 are the two switches above the joystick and ribbon. These on/off switches can perform a number of different functions, such as modulating sounds or effects, or locking the modulation values of the joystick, ribbon, or aftertouch.

Also, each one may work either as a toggle, or as a momentary switch. In **Toggle** mode, each press alternates between on and off; in **Momentary** mode, the switch only changes for as long as you hold it down.

Each Program, Combination, and Song stores its own settings for what the switches will do, and whether each switch is on or off (based on their current states when the data is saved). You can also make settings for Sampling mode as a whole.

You can set up SW1/2 on the Set Up Controllers page.

Programs (HD-1 and EXi)	P1: Basic/Vector
Combinations and Songs	P1: EQ/Vector/Controller
Sampling mode	P4: EQ/Controller

An example of settings in a Program

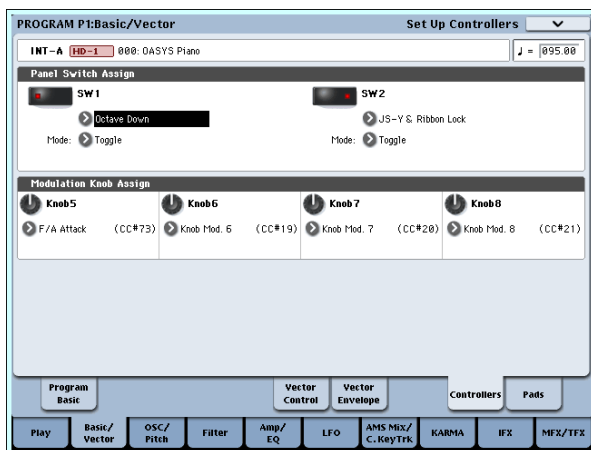

When using SW1/2 for AMS or Dmod, the default settings are SW1 Mod.:CC#80 and SW2 Mod.:CC#81.

For an example, see “Using Dmod to change the feedback level via SW1” on page 191. For a complete list of the possible assignments, see “SW1/2 Assignments” on page 979 of the Parameter Guide.

Note: If you wish to keep these settings after the power is turned off, you must save the Program, Combination, or Song. Note that the settings for Sampling mode cannot be saved.

Setting the functions of REALTIME KNOBS 5–8

When the Control Surface CONTROL ASSIGN is set to R.TIME KNOBS/KARMA, the four knobs on the right function as Realtime Knobs 5-8 (User 1-4). These can perform a number of different functions, such as modulating sounds or effects, adjusting effects send levels, and so on.

Each Program, Combination, and Song stores its own settings for what the knobs will do. You can also make settings for Sampling mode as a whole.

When using the knobs for AMS or Dmod, it’s important to understand that assignment is a two-step process. First, you assign the knob to send a MIDI controller, such as Knob Mod.1 (CC#17). Second, you assign that MIDI controller to modulate one or more Program or effects parameters.

For the first part of the above, use the mode’s Set Up Controllers page. (See “Setting the functions of SW1 and SW2,” above.)

The default assignments for knobs 5-8 are Knob Mod.1 (CC#17), Knob Mod.2 (CC#19), Knob Mod.3 (CC#20), and Knob Mod.4 (CC#21), respectively. For a complete list of the possible assignments, see “Realtime Knobs 5–8 Assignments” on page 980 of the Parameter Guide.

Here’s an example of how to set up knob 5 (User 1) to control a Program’s filter and amp EG attack time:

1. Press the PROG switch to enter Program mode.
2. Press the Basic/Vector tab, and then the Controllers tab above it, to go to the P1: Basic/Vector– Set Up Controllers page.
3. Press the Modulation Knob Assign “Knob 5” popup button, and choose F/A Attack.
4. Press the front-panel R.TIME KNOBS/KARMA button (under CONTROL ASSIGN).
5. Turn knob 5 (USER 1) to control the filter and amp EG attack.

Note: If you wish to keep these settings after the power is turned off, you must save the Program, Combination, or Song. Note that the settings for Sampling mode cannot be saved.

Adjusting the brightness, contrast, and color of the LCD

These settings are made using the Global P0 page menu command “LCD Setup.”

1. Press the GLOBAL switch to enter Global mode.

2. Press the Basic tab in the lower line, and then the Basic tab located above it. The P0: Basic Setup–Set Up Controllers page will appear.

3. From the page menu located in the upper right of the LCD, choose "LCD Setup" to open the dialog box.
4. Set the various parameters. Pressing the RESET button will reset the parameters to their default values.
5. Press the OK button to execute the changes you made, or press the Cancel button if you decide not to execute.

Using tap tempo

In Program, Combination and Sequencer modes, you can use the tap tempo function to control the KARMA tempo. In Sequencer mode you can use this method to control the song tempo.

During playback, lightly press the TAP TEMPO switch several times at the desired tempo. The tempo will follow your tapping in realtime. This is a convenient way to match the tempo in realtime to the beat of a different source.

As an example, here's the procedure for using tap tempo to set the speed of the KARMA.

1. In Program mode or Combination mode, start the KARMA function running.

Turn on the KARMA ON/OFF switch, and play a key or a pad. (If you press the LATCH switch, the KARMA function will continue playing even after you take your finger away.)

2. Lightly press the TAP TEMPO switch several times at the desired tempo.

Notice that the "♩=" in the upper right of the LCD screen will change to indicate the tempo at which you press the TAP TEMPO switch.

If you press the TAP TEMPO switch at slightly shorter intervals, the playback tempo will become correspondingly faster.

⚡ You can use tap tempo control whenever the TEMPO knob can be operated. For example in Sequencer mode, tap tempo control will not be available if you are playing a song whose "Tempo Mode" setting is set to Auto.

Note: You can also use a foot switch connected to the ASSIGNABLE FOOT SWITCH jack to control the tap tempo function. For more information, see "Foot Switch Assignments" on page 981 of the Parameter Guide.

Resetting controller values

The vector joystick position can be reset to the center, or the controllers of the control surface can be reset or switched to stored values.

If you want to reset a controller individually, hold down the RESET CONTROLS switch and operate the control surface slider, knob, or switch that you want to reset. Alternatively, operate the vector joystick.

If you want to reset all of the control surface sliders, knobs, and switches in a CONTROL ASSIGN unit (a tab within the Control Surface page) in a single operation, hold down the RESET CONTROLS switch and press the corresponding CONTROL ASSIGN switch. (Solo is an exception. See below.)

Vector Joystick

If you hold down the RESET CONTROLS switch and move the vector joystick, the vector joystick value will be reset to the center position. This is convenient when you've operated the joystick and want to return to the state in which the program or combination was when you selected it. You can check the position in the vector graph of each mode (P1- Vector Control, Vector Envelope).

KARMA MODULE CONTROL switch

The fader, switch, and scene settings of the currently-lit KARMA module will be reset to the values written in the program or combination. In Sequencer mode, the settings will be reset to the values that were in effect when you entered the mode, selected the song, or executed Copy From Combi, etc.

SOLO switch

If even one SOLO is On, the SOLO switch will blink.

If you hold down the RESET CONTROLS switch and press the SOLO switch, all SOLO settings will be reset to Off.

CONTROL ASSIGN:

MIXER [TIMBRE/TRACK] 1-8, 9-16
MIXER [AUDIO] INPUTS, HDR 1-8, HDR 9-16
[EXTERNAL]
MOD [R.TIME KNOBS/KARMA]
MOD [TONE ADJUST]

MIXER & MODULATION:

MIX CHANNEL STRIP, REALTIMEKNOBS
MIX PLAY/MUTE, KARMA SCENES
MIXER SELECT, KARMA SWITCH
MIX VOLUME, KARMA CONTROLS

If you hold down the RESET CONTROLS switch and operate a MIXER & MODULATION controller (knob, fader, or switch) or a CONTROL ASSIGN switch (when the LED is lit), the program or combination will be reset to the written values. A sequencer song will be reset to the state in which it was immediately after you entered the mode, selected the song, or executed Copy From Combi, etc.

If you operate a MIXER & MODULATION controller (knob, fader, or switch), only the controller you operated will be reset.

If you press a CONTROL ASSIGN switch (when the LED is lit), the values of all corresponding MIXER & MODULATION controllers will be reset.

Note: Resetting the REALTIME KNOBS of MODE R.TIME KNOBS/KARMA will set them to the center position.

Note: MODE TONE ADJUST will be reset as follows, depending on the parameter that is assigned. For a program, absolute-type parameters will be reset to the specified value, and relative-type parameters

will be reset to the center.

For a combination, they will be reset to the written values. For a sequencer song, they will be reset to the state in which they were immediately after you entered the mode, selected the song, or executed Copy From Combi, etc.

Shortcuts

ENTER switch + numeric keys 0–9

- Accesses the page menu commands in each page (up to ten items)

ENTER switch + REC/WRITE switch

- Accesses the Auto Song Setup function. In Program or Combination mode you can press this combination of keys to automatically assign the settings of the program or combination to a song in Sequencer mode, and then enter record-ready mode.

ENTER switch + keyboard

- Inputs note number values or velocity values
- Selects “KEY” in Global P5: Drum Kit, Sequencer P5: Pattern/RPPR, RPPR Setup page
- Selects base key and index in Sampling mode

ENTER switch + LOCATE switch

- In Sequencer mode, sets the current location as the “Location” (equivalent to the “Set Location” page menu command)

KARMA MODULE CONTROL switch + CONTROL ASSIGN R.TIME KNOBS/KARMA switch (LED ON)

In Combination or Sequencer mode, set Module Control to Master. (The same operation as setting Module Control=M in P0: Control Surface–RT/KARMA)

CONTROL ASSIGN TONE ADJUST switch (LED ON) + SWITCH 1...16 switches

In Combination or Sequencer mode, these select the timbre or MIDI track that you will control. (The same operation as selecting a Timbre/Track in P0: Control Surface)

EXIT switch

This button makes it easy to return to the main page of the current mode:

- Press it once to go to the previously-selected tab on the main P0 page.
- Press it again to go to the first tab on the main P0 page.
- Press it a third time to select the main parameter on the P0 page, such as the Program name in Program mode.

Wherever you are in Program, Combi, or Sequencer modes, pressing EXIT three times (or fewer) will take you back to Program/Combination/Song Select,

where you can immediately use the numeric keys or \triangle/∇ switches to select a Program, Combination, or Song.

EXIT switch (in dialog boxes)

When a dialog box is displayed, this has the same function as the Cancel, Done, or Exit button.

Using Effects

For effects processing, the OASYS provides 12 insert effects, two master effects, and two total effects, together with a mixer section that controls the routing of these effects. All of these are stereo in/out.

Specific parameters of these effects can also be controlled in real time from the OASYS' controllers or via MIDI messages using Dynamic Modulation (Dmod), by MIDI/Tempo Sync, or by using a common LFO to apply synchronized change to differing modulation effects.

Effect types

You can choose from 185 different full-digital effects.

The effects are categorized as follows.

Classification of 185 effects

Dynamics: 000...010	Effects which control volume, such as compressors, limiter, and gates
EQ/Filter: 011...026	Effects which control frequency content, such as EQ, multi-mode filter, exciter, and wah
OD/Amp/Mic: 027...039	Overdrive and amp modeling effects such as guitar/bass amps and mics
Cho/Fln/Phs: 040...054	Pitch and phase modulation effects such as chorus and flanger
Mod/P.Shift: 055...076	Other modulation effects such as tremolo and rotary speaker, and pitch shifters
Delay: 077...099	Delays
Reverb/ER: 100...108	Reverb and early reflections
Mono-Mono: 109...140	Mono & Mono chain effects that internally connect two mono effects in series
Mono/Mono: 141...185	Mono & Mono parallel effects that allow two mono effects to be applied to L and R independently

Maximum number of effects and maximum voice polyphony

For each effect IFX1–12, MFX 1 and 2, and TFX 1 and 2, you are free to choose and use any of 185 types of effect. There is no limitation on the maximum number or type of effects you can use.

However, a certain amount of digital processing capability must be internally allocated in order to produce each effect. The Effect/EXi Fixed Resource Meter shows the amount of processing power currently being used. You can find the meter on the Track View tab of the P8: Insert Effect– Insert FX page, and the Routing tab of the P9: Master/Total Effect page.



Please note that power used by the effects will have an impact on the available number of voices. For more information, see “About polyphony” on page 33.

Effect I/O

Insert effects

Insert Effects (IFX 1–12) are stereo-in/stereo-out. If you select Dry (unprocessed) for the **Wet/Dry** parameter, the stereo input signal will be output in stereo without being processed by the effect. If you select Wet (effect applied), the processed signal will be output in one of the following ways:

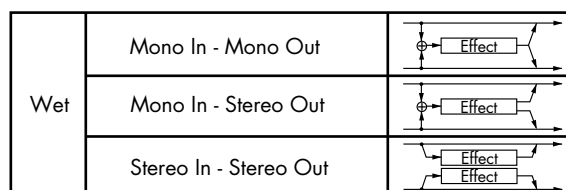

Master Effects

The I/Os of Master Effects MFX1 and MFX2 are stereo-in/stereo-out. **Send1** and **Send2** determine the send level to the Master Effects.

Master effects will not output the Dry (unprocessed) signal specified in **Wet/Dry**. Only the Wet (processed) signal will be output. The output signals from the Master Effects are routed to the L/R bus with the output level specified by **Return1** and **Return2**. These output signals are mixed with the output signals from the bus specified by **Bus Select** (P8: “Routing” page in each mode) L/R, or with the output signals from the bus specified by **Bus Select** (“Insert FX” page in each mode) L/R, then routed to the total effect.

Selecting “000: No Effect” will mute the output. The processed signal will be output in one of the following ways, according to the type of effects 001–185.

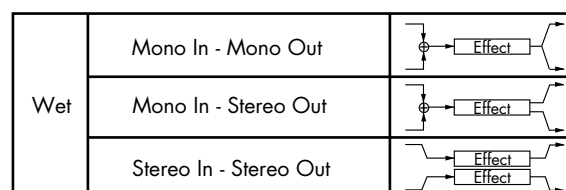

Total Effects

The total effects TFX1 and TFX2 are stereo-in/stereo-out. The Dry (unprocessed) side of the **Wet/Dry** parameter sends the stereo input sound directly to the stereo output. The way in which the Wet (processed) side is output depends on the type of effect, as follows.

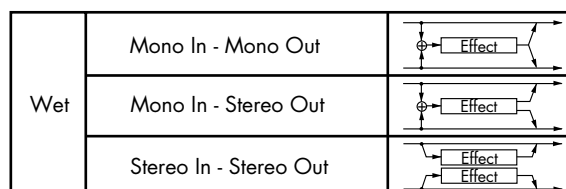

Note: The Parameter Guide includes block diagrams for each individual effect, which include the effect's input/output structure.

Effects in each mode

Program mode

For programs of HD-1, you can use insert effects to process the final sound in the same way that you use the Filter, Driver, Amplifier, and EQ (equalizer) to process the sound from the oscillators (OSC 1 & 2). Then the master effects are used to create overall ambience such as reverb, and use the total effects to make final adjustments. All of these settings can be made independently for each program. Programs of EXi have a different filter and amp structure for each type, but you can also apply insert effects, master effects, and total effects to the oscillators (EXi1&2), just as for a HD-1 program.

Combination and Sequencer modes

In Combination and Sequencer modes, you can use the track EQ and insert effects to process the program sound (and audio track sound) of each timbre/track. Then you can use the master effects to create overall ambience, and use the total effects to make final adjustments.

In Combination mode you can make these settings for each combination, and in Sequencer mode you can make them for each song.

In Sequencer mode, you can switch between effects or modify the effect parameters and record these changes, so that effects will switch automatically or effect parameters will be modified automatically as the song plays back.

Sampling mode

In Sampling mode, external audio sources from AUDIO INPUT 1, 2, 3, 4, and S/P DIF IN jacks or the playback from the internal CD-R/RW drive or a USB-connected CD drive can be processed by insert effects, master effects, and total effects, and then sampled. Use the P0: Recording- Audio Input page to make audio input settings for Sampling mode. These settings apply only to Sampling mode.

Samples that you've assigned as a multisample can also be processed by the insert effects, master effects, and total effects, and then resampled.

Audio Input

You can also input audio sources from AUDIO INPUT 1, 2, 3, 4, and S/P DIF IN jacks in modes other than Sampling mode (i.e., in Program, Combination, and Sequencer modes).

You can apply the insert effects, master effects, and total effects to external audio sources from these jacks and sample them, or use the OASYS as a 6-in (AUDIO INPUT 1, 2, 3, 4, S/P DIF IN L, R) 10-out effect processor.

You can also use an external mic input to control a vocoder effect (093: Vocoder), and modulate the internal sounds. For examples, see "Example: Vocoder (Program)" on page 731 of the Parameter Guide and "Example: Rhythmic Vocoder (Combination)" on page 732 of the Parameter Guide.

In Sequencer mode you can also use the effects when recording external audio sources to audio tracks.

Use the P0- Audio Input/Sampling page of each mode to make audio input settings. Alternatively, you can check **Use Global Setting** and make these settings in the Global mode P0: Basic Setup- Audio page.

Normally you will leave **Use Global Setting** checked.

Program mode

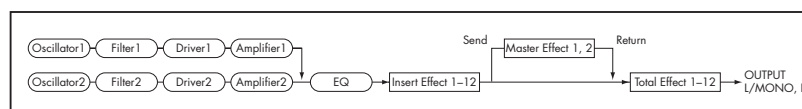

Combination and Sequencer modes

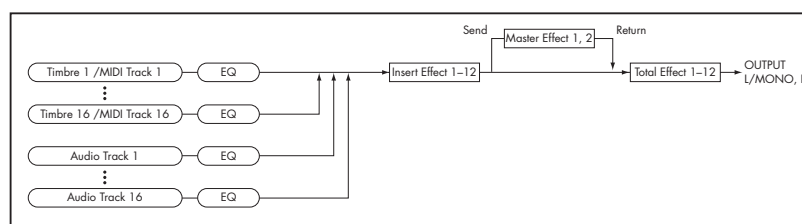

Sampling mode

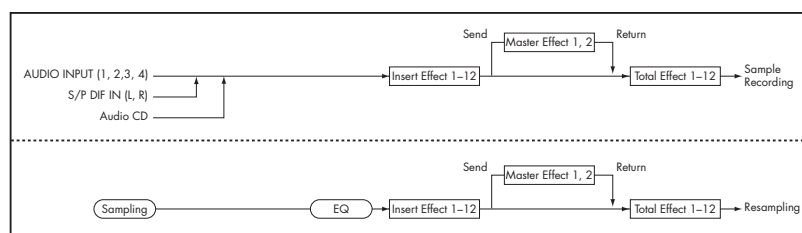

Audio Input

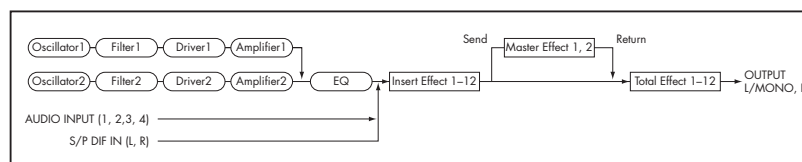

Uncheck this if you want programs and combinations to use their own settings. For example when writing the program as a vocoder effect program.

- When effects are applied to the external input sound from the AUDIO INPUT 1, 2, 3, 4, and S/P DIF IN jacks, certain effect types or parameter settings may

cause oscillation to occur. If this occurs, adjust the input level, output level, or effect parameters. Please be aware of this particularly when using an effect that has a high gain.

Routing effect settings

The insert effects, master effects, and total effect have the same structure in all modes, but the routing settings will determine how the oscillators of a program or the timbres of a combination or track of a song will be sent to each insert effect, master effect or total effect. In the pages that follow, we will explain how you can make routing settings and effect settings in each mode.

Program Effects settings

Routing

1. Access the Program P8: Insert Effect– Routing page.

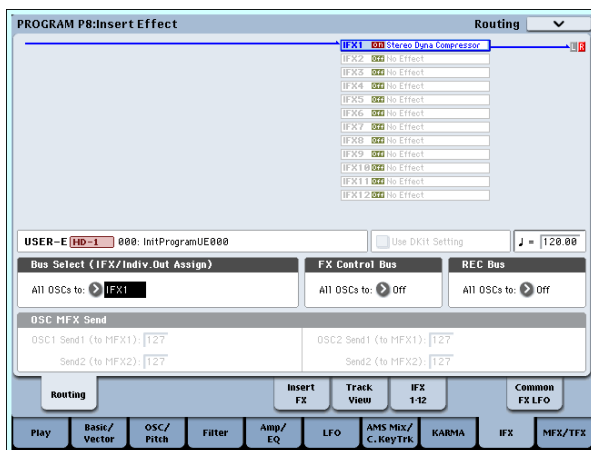

2. Use Bus Select (IFX/Indiv. Out Assign) to specify the bus to which the oscillator output will be sent. If you want the oscillator output to be input to insert effect 1, choose IFX1.

L/R: The output will not be sent to the total effects. After passing through the total effect, the sound will be sent to AUDIO OUTPUT (MAIN) L/MONO and R.

IFX1–12: The output will be sent to insert effect IFX 1–12.

1–8, 1/2–7/8: The output will be sent to AUDIO OUTPUT (INDIVIDUAL) 1–8. It will not be sent to the insert effects, the master effects, or the total effects.

Off: The output will not be sent to AUDIO OUTPUT (MAIN) L/MONO, R, or to (INDIVIDUAL) 1–8. Choose this if you want the signal to be series-connected to the master effects at the send levels specified by “Send 1 (MFX1)” and “Send 2 (MFX2).”

3. OSC MFX Send specifies the send level from each oscillator to the master effects.

This can be set only when “Bus Select (IFX/Indiv.Out Assign)” is either L/R or Off.

If “Bus Select (IFX/Indiv.Out Assign)” is set to IFX1–12, the send level to the master effects is set by **Send1** and **Send2** (Insert FX page) after the signal passes through the insert effects.

4. “FX Control Bus (All OSCs to)” sends the oscillator 1 and 2 output to the FX Control bus. Use this if you want the audio input to the effect to be controlled by a different sound.

You can use the two FX Control buses to control effects freely. (See PG p.575 “4. FX Control Bus”)

5. REC Bus sends the oscillator 1 and 2 output to the REC buses.

In the P0– Audio Input/Sampling page, you can set the Sampling Setup **Source Bus** to a REC bus, and sample the signal being sent to the REC bus.

Normally you will turn this Off, since you will usually set **Source Bus** to L/R when sampling the output of oscillator 1 and 2.

Insert effects

6. Access the Insert FX page.

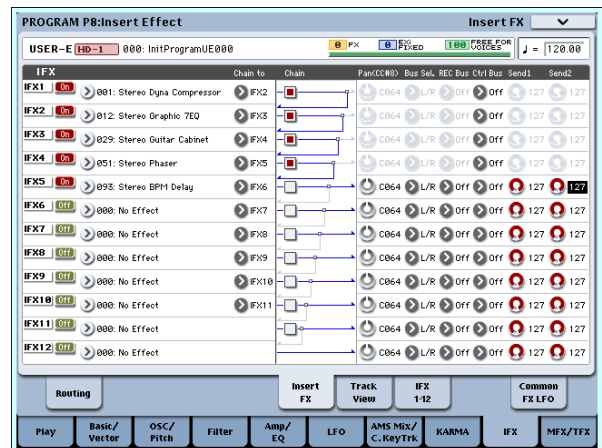

7. Choose the effect type that you want to use for each insert effect IFX1–12.

When you press the popup button, all effects will be displayed, organized into nine categories. Use the pages located at the left to select a category, and select an effect from that category on the LCD screen.

You can use the “Copy Insert Effect” page menu command to copy effect settings from another program etc. Also, you can use “Swap Insert Effect” to exchange (for example) IFX1 and IFX12.

8. Press the On/Off button to turn on the insert effect.

Each time you press the button, the insert effect will be switched on/off. When Off, the result will be the same as when 000: No Effect is selected. The input sound will be output without change.

9. Make Chain settings.

If the **Chain** check box is checked, the insert effect will be connected in series. Since the output of the oscillator is being sent to IFX1 in step 2, making settings as shown in the diagram step 6 would connect all five insertion effects IFX1 → IFX2 → IFX3 → IFX4 → IFX5 in series, so that these effects would be inserted into the output of the oscillator.

10. Make settings for Pan (CC#8), “Bus Sel. (Bus Select),” “Send 1,” “Send 2,” REC Bus and “Ctrl Bus” for the sound after it has passed through the insert effects.

If you’ve specified a chain, the settings that follow the last IFX in the chain will be valid (except for “Ctrl Bus”).

Pan: Sets the pan of the IFX output.

Bus Sel. (Bus Select): Specifies the output destination. Normally you will set this to L/R. If you wish to send the sound that has passed through the insert effects to AUDIO OUTPUT (INDIVIDUAL) 1–8, select 1–8, 1/2, or 7/8.

Send 1, Send 2: Sets the send levels to the master effects. For this example, set this to 127.

Ctrl Bus: The FX Control Buses lets you create effects “sidechains.” Sidechains let you control an effect with one audio signal (the sidechain), while the effect processes a completely different audio signal. This is convenient for use with vocoders, compressors and limiters, gates, etc. For more information, see “FX Control Buses” on page 730 of the Parameter Guide.

REC Bus: The sound processed by the insert effect will be sent to the REC bus. In the P0– Audio Input/Sampling page, you can set the Sampling Setup **Source Bus** to a REC bus, and sample the signal that is sent to the REC bus. Use this if you want to sample only the sound of an audio input source being processed by an insert effect (and not sample the sound of the oscillator output). Alternatively, the direct sound from the audio inputs can be mixed with the sound processed by an insert effect, sent to a REC bus, and sampled.

11. Go to the P8: Insert Effect– Insert FX page, and edit the parameters of the insert effect you selected.

Press the IFX 1–12 tab, use the tabs at the left to select IFX1–12, and edit the effect parameters.

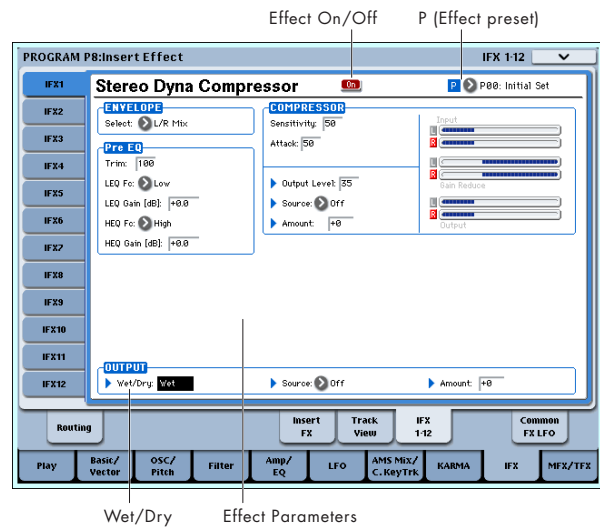

Effect 1 On/Off: Turns the insert effect on/off. This is linked with the on/off setting in the Insert FX page.

P (Effect Preset): Selects an effect preset. The OASYS’ internal memory contains “effect presets” which are parameter settings for each effect from 001: St.Dyna Compressor through 185: Mt.BPM Dly //Mt.BPM Dly.

Effect parameters you edit are saved as part of each program, but effect presets allow you to save favorite parameter settings for each effect. If you’ve come up with an effect setting you like, use the page menu command “Save to User Preset” to save it as a preset so that you can easily recall it in a different program or mode.

For details on the individual effects, see:

- “Dynamics” on page 764 of the Parameter Guide
- “EQ and Filters” on page 773 of the Parameter Guide
- “Overdrive, Amp models, and Mic models” on page 788 of the Parameter Guide
- “Chorus, Flanger, and Phaser” on page 797 of the Parameter Guide
- “Modulation and Pitch Shift” on page 809 of the Parameter Guide
- “Delay” on page 829 of the Parameter Guide
- “Reverb and Early Reflections” on page 849 of the Parameter Guide
- “Mono-Mono Serial” on page 854 of the Parameter Guide
- “Mono/Mono Parallel” on page 877 of the Parameter Guide

Master effects

12. The input levels to the master effects are set by the “Send 1, 2” levels (step 3 or 10). If “Send 1, 2” are zero, the master effects will not apply. “Send 1” corresponds to MFX1, and “Send 2” corresponds to MFX2.

13. Access the Program P9: Master/Total Effect– Routing page.

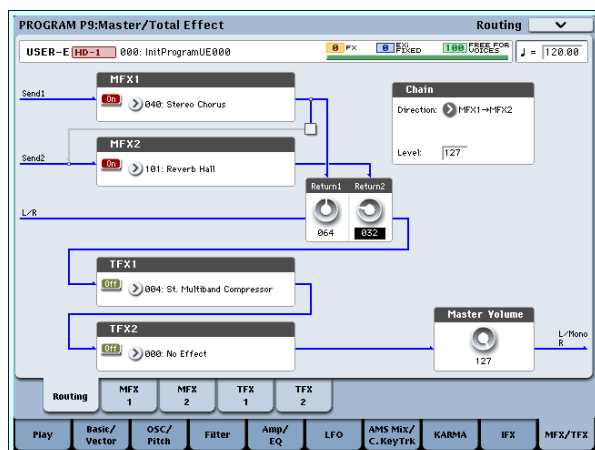

14. In MFX1 and MFX2, select the type of each master effect.

The procedure is the same as when selecting an insertion effect (see step 7).

15. Press the On/Off button to turn on the master effect.

Each time you press the button, the master effect will be switched on/off. When Off, the output of the master effect will be muted.

16. Use "Return 1" and "Return 2" to adjust the output levels of the master effects.

Note: For each effect, the Wet value of the Wet/Dry parameter is the output level at the effect. The return value is multiplied with this ("Return" = 127 will be x1.0) to determine the actual output level of the master effect.

17. Select the MFX1 and MFX2 pages, and set the parameters for each selected effect.

For details on the "Program Effects settings" step 11.

Total Effects

18. If you use "Bus Select (IFX/Indiv.Out Assign)" to choose L/R as the oscillator output, or if you set the post-IFX Bus Select to L/R, the signal will be input to the total effect.

The output from the master effects is input to the total effects via the "Return 1" and "Return 2" settings of the Program P9: Master/Total Effect–Routing page.

After being processed through the total effects, the signal is output from the AUDIO OUTPUT (MAIN) L/MONO and R outputs.

19. Access the Program P9: Master/Total Effect–Routing page.

20. Choose the desired total effect for TFX1 and TFX2. The procedure is the same as when selecting an insert effect. (See step 7)

21. Press the On/Off button to turn the total effects on.

The total effect will be switched on/off each time you press the button. If this is Off, the result will be the same as if 000: No Effect is selected. The input sound will be output without change.

22. Access the TFX1 or TFX2 pages, and edit the parameters of each effect to adjust the final sound as desired.

For details on the "Program Effects settings" step 11.

Using effects in Combinations and Songs

In Combination, and Sequencer modes, you can specify the routing of each timbre/track to the insert effects, master effects and total effects. These settings are made in the same way in each of these modes. We will be using the example of Combination mode in our explanation here.

Routing

1. Access the Combination P8: Insert Effect–Routing1 page.

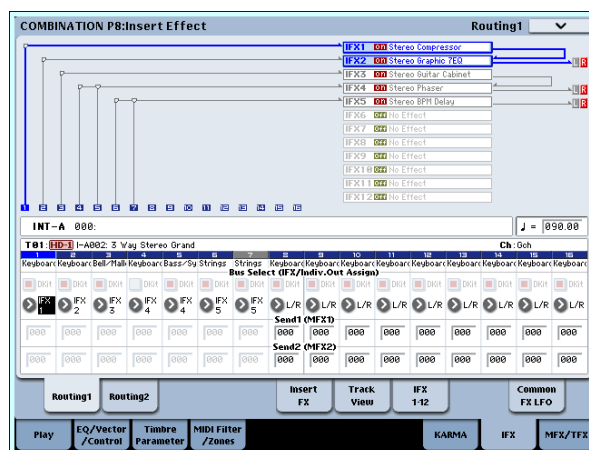

2. Use "Bus Select (IFX/Indiv.Out Assign)" to specify the bus to which each timbre will be output. Choose IFX1 if you want to send the output of a timbre to insert effect 1.

The routing, insert effects, and chain settings are shown graphically in the upper part of the display screen. In this example, T01 (timbre 1) uses IFX1 and 2. T02 uses IFX2, T03 uses IFX3 and 4, T02 and T05 use IFX4, and T06 and T07 use IFX5.

3. Use Send1 and Send2 to specify the send level of each timbre to the master effects.

This can be set only if "Bus Select (IFX/Indiv.Out Assign)" is set to L/R or Off.

Note: The actual send level is determined by multiplying this by the "Send 1" or "Send 2" settings for oscillators 1 and 2 within the program selected by the timbre. If the program parameter "Send 1" or "Send 2" is set to 0, the resulting level will still be 0 even if you raise this send level.

If "Bus Select (IFX/Indiv.Out Assign)" is set to IFX1–12, the send levels to the master effects are set by Send1 and Send2 (Insert FX page) following the insert effects.

4. Access the Combination P8: Insert Effect–Routing 2 page.

Bus Select (IFX/Indiv. Out Assign) is the same as in the Routing 1 page. You can set it from either page.

FX Control Bus sends the output of the timbre to an FX Control bus. Use this when you want the audio input to an effect to be controlled by another sound. There are two FX Control buses, which gives you a great deal of freedom for controlling effects freely. (See PG p.575 "4. FX Control Bus")

REC Bus sends the output of the timbre to a REC bus. In the P0– Audio Input/Sampling page, you

can set the Sampling Setup **Source Bus** to a REC bus, and sample the signal that is sent to the REC bus. Use this if you want to sample only the sound of a specific timbre.

Note: Sequencer mode has settings for MIDI Routing 1/2 and Audio Routing 1/2. These specify the effect routing for MIDI tracks and audio tracks.

In Sequencer mode, you can also choose a REC bus as the **REC Source** for each track in the P0– Audio Track Mixer page, so that the signals sent to the REC bus(es) can be recorded to the hard disk.

Insert effects

5. Access the Combination P8: Insert Effect– Insert FX page.

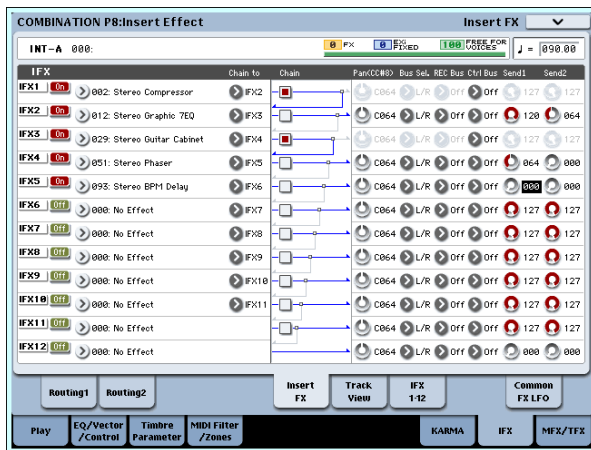

6. Choose the effect type that you want to use for each insert effect IFX1–12.

Press the popup button, and choose an effect from the nine categories.

7. Press the On/Off button to turn on the insert effect.

Each time you press the button, the insert effect will be switched on/off. When Off, the result will be the same as when 000: No Effect is selected. The input sound will be output without change.

8. Make Chain settings.

If the **Chain** check box is checked, the insert effect will be connected in series.

Make settings for **Pan (CC#8)**, “Bus Sel. (Bus Select),” “Send 1,” “Send 2,” **REC Bus** and “Ctrl Bus” for the sound after it has passed through the insert effects.

If you’ve specified a chain, the settings that follow the last IFX in the chain will be valid (except for “Ctrl Bus”).

Pan: Sets the pan.

Bus Sel. (Bus Select): Specifies the output destination. Normally you will set this to L/R. If you wish to send the sound that has passed through the insert effects to AUDIO OUTPUT (INDIVIDUAL) 1–8, select 1–8, 1/2, or 7/8.

Send 1, Send 2: Sets the send levels to the master effects. For this example, set this to 127.

Ctrl Bus: The FX Control Buses lets you create effects “sidechains.” Sidechains let you control an effect with one audio signal (the sidechain), while

the effect processes a completely different audio signal. This is convenient for use with vocoders, compressors and limiters, gates, etc. For more information, see “FX Control Buses” on page 730 of the Parameter Guide.

REC Bus: The sound processed by the insert effect will be sent to the REC bus. In the P0– Audio Input/Sampling page, you can set the Sampling Setup **Source Bus** to a REC bus, and sample the signal that is sent to the REC bus. Use this if you want to sample only the sound of an audio input source being processed by an insert effect (and not sample the sound of the oscillator output). You can also use this if you want to sample only a specific timbre. Alternatively, the direct sound from the audio inputs can be mixed with the sound processed by an insert effect, sent to a REC bus, and sampled.

Note: In Sequencer mode, you can also choose a REC bus as the **REC Source** for each track in the P0– Audio Track Mixer page, so that the signals sent to the REC bus(es) can be recorded to the hard disk.

MIDI You can use MIDI to control dynamic modulation (Dmod) for each effect, the post-IFX pan (CC#8), and Send 1 and Send 2.

An asterisk “*” is shown at the right of Ch01–Ch16 for the channel number of tracks routed to IFX. If you’ve routed multiple tracks that have differing MIDI channel settings, this specifies the channel on which they will be controlled.

9. Go to the IFX1–12 pages to edit the individual effect parameters.

For more details, see step 11 under “Program Effects settings,” beginning on page 185.

Master effects and Total effects

These settings can be made in the same way as in “Program Effects settings” (p.186).

MIDI You can control these effects via MIDI on the “Ctrl Ch.” The specified MIDI channel will control dynamic modulation (Dmod) for the Master and Total Effects.

Effect settings in Sampling mode

In Sampling mode, you can apply effects to external audio sources from the AUDIO INPUT 1–4 and S/P DIF IN jacks, and sample the result. You can also apply effects to the audio from the internal CD-R/RW drive or a USB-connected audio CD, and sample the result. It’s also possible to apply effects to a multisample and resample the result.

Routing of an external input

1. Go to the Sampling P0: Recording– Audio Input page.

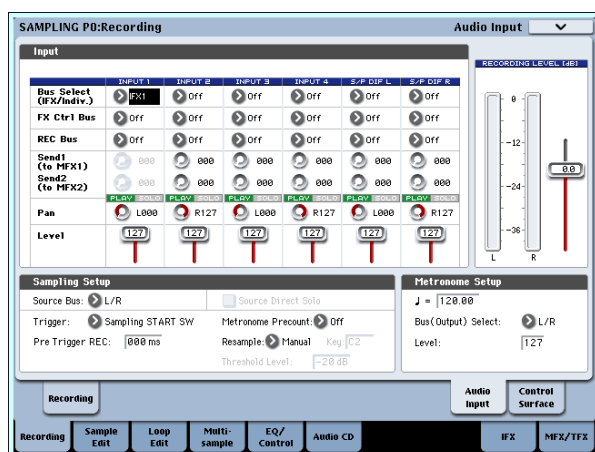

2. Use **Bus Select (IFX/Indiv.)** to specify the bus to which each audio input will be sent.

For example if you want the signal from a device connected to AUDIO INPUT 1 to be input to insert effect 1, set the INPUT 1 **Bus Select (IFX/Indiv.)** to IFX1.

3. Use **Send1** and **Send2** to specify the send level of each timbre to the master effects.

This can be set only if **Bus Select (IFX/Indiv.)** is set to L/R or Off.

If **Bus Select (IFX/Indiv.)** is set to IFX1–12, the send levels to the master effects are set by **Send1** and **Send2** (Insert FX page) following the insert effects.

4. Set **PLAY/MUTE** and **Solo On/Off** as desired. You can use the control surface to make these settings.

5. Use **Pan** to set the panning of the audio input.

If you're inputting a stereo audio source, you will normally set the inputs to L000 and R127 respectively.

6. Use **Level** to adjust the level of the audio input.

Normally you will leave this at 127.

7. **FX Control Bus** sends the output of the timbre to an FX Control bus.

The FX Control Buses lets you create effects "sidechains." Sidechains let you control an effect with one audio signal (the sidechain), while the effect processes a completely different audio signal. This is convenient for use with vocoders, compressors and limiters, gates, etc. For more information, see "FX Control Buses" on page 730 of the Parameter Guide.

8. **REC Bus** sends the audio input to a REC bus.

By selecting a REC bus as the "Source Bus," you can sample the signal that's being sent to the REC bus.

Normally when sampling in this mode, you will turn this Off, since the **Source Bus** will be set to L and R.

Insert effects

9. Go to the Insert FX page.

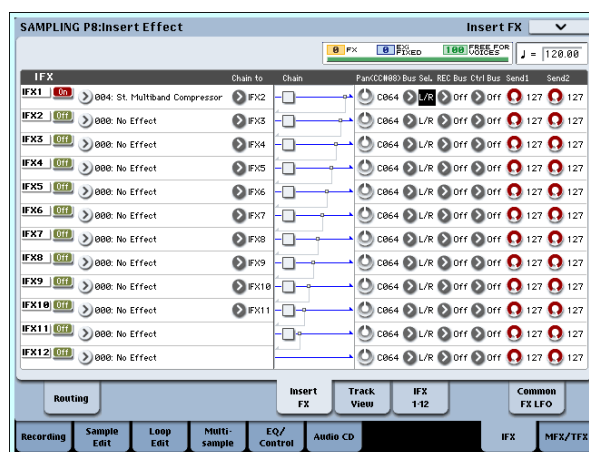

10. Choose the insert effect that you want to use on the audio input.

Press the popup button, and choose an effect from the nine categories.

11. Press the **On/Off** button to turn on the insert effect.

Each time you press the button, the insert effect will be switched on/off. When Off, the result will be the same as when 000: No Effect is selected. The input sound will be output without change.

12. Make **Chain** settings.

If the **Chain** check box is checked, the insert effect will be connected in series.

13. Make settings for **Pan (CC#8)**, "**Bus Sel.** (**Bus Select**)," "**Send 1**," "**Send 2**," **REC Bus** and "**Ctrl Bus**" for the sound after it has passed through the insert effects.

If effects are chained, the settings that follow the last IFX are valid (except for "Ctrl Bus").

Pan: Sets the pan.

Bus Sel. (Bus Select): Specifies the output destination. Normally you will set this to L/R. If you wish to send the sound that has passed through the insert effects to AUDIO OUTPUT (INDIVIDUAL) 1–8, select 1–8, 1/2, or 7/8.

Send 1, Send 2: Sets the send levels to the master effects. For this example, set this to 127.

Ctrl Bus: The signal processed by the insert effect will be sent to the FX Control bus. Use this if you want to use another sound to control the audio being input to an effect. You can use the two FX Control buses to control effects freely.

For more information, see "FX Control Buses" on page 730 of the Parameter Guide.

REC Bus: The sound processed by the insert effect will be sent to the REC bus. In the P0– Audio Input page, you can set the Sampling Setup **Source Bus** to a REC bus, and sample the signal that is sent to the REC bus. Normally you will sample with **Source Bus** set to L/R and **REC Bus** turned Off. However by using the REC bus, the direct sound of the audio input and the sound processed by the insert effect can be mixed to a REC bus and sampled.

14. Access the IFX1–12 pages and edit the parameters of each effect.

For more details, see step 11 under “Program Effects settings,” beginning on page 185.

Master effects and Total effects

These settings can be made in the same way as in “Program Effects settings” (p.186).

For details on applying an effect to an external audio input and sampling the result, refer to p.107.

Sending the output of a multisample to an effect bus

1. If you want the samples assigned to a multisample to be sent to an effect bus, go to the Sampling P8: Insert Effect– Routing page, and make settings for “Bus Select (All OSCs to)”.

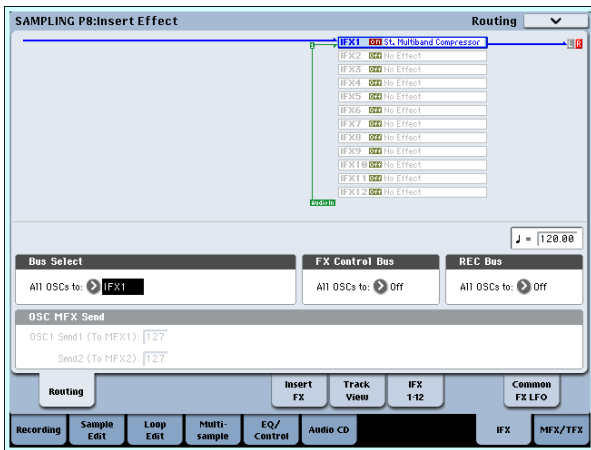

For details on applying an effect to a multisample and resampling, refer to p.108.

Effect settings for the audio inputs

Just as you can in Sampling mode, the Program, Combination, and Sequencer modes also let you apply the OASYS’ effects to the signals from the AUDIO INPUT 1–4 and S/P DIF IN jacks and sample the result, or to use the OASYS as a 6-in (AUDIO INPUT 1, 2, 3, 4, S/P DIF L, R) 10-out effect processor. You can also use the OASYS as a vocoder effect (026:Vocoder) that uses an external mic input to control the internal sounds.

Input-related settings are made in the P0– Audio Input/Sampling page of each mode. Normally, you will make settings in the Global mode P0: Basic Setup– Audio page and share these settings in all modes, but you can also make individual settings for a specific program (in Program mode) if, for example, you want to use that program as a vocoder.

Routing

1. Access the Global P0: Basic Setup– Audio page.

Note: You must move to Global mode from the mode (other than Sampling mode) in which you want to input the external audio signals. If you move from Sampling mode to Global mode, the Audio Input settings of Sampling mode will be maintained, and you won’t be able to view the settings of this page.

These settings are not used in Sampling mode. Audio input settings for Sampling mode are made in the Sampling P0: Recording– Audio Input page.

- ⚠ When applying effects to the signals from the AUDIO INPUT 1–4 and S/P DIF IN jacks, oscillation may occur depending on the effect type and parameter settings. If so, adjust the input level, output level, and effect parameters. In particular, use caution when using high-gain effects.

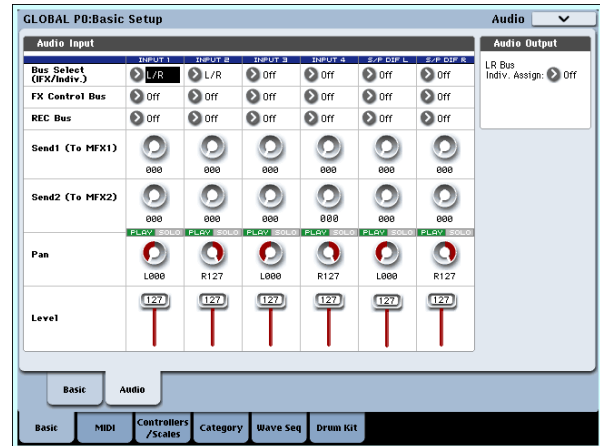

2. Use Bus Select (IFX/Indiv.) to specify the bus to which each audio input will be sent.

For example if you want the signal from a device connected to AUDIO INPUT 1 to be input to insert effect 1, set the INPUT 1 Bus Select (IFX/Indiv.) to IFX1.

3. Use Send1 and Send2 to specify the send level of each timbre to the master effects.

This can be set only if Bus Select (IFX/Indiv.) is set to L/R or Off.

If Bus Select (IFX/Indiv.) is set to IFX1–12, the send levels to the master effects are set by Send1 and Send2 (Insert FX page) following the insert effects.

4. Set PLAY/MUTE and Solo On/Off as desired. You can use the control surface to make these settings.
5. Use Pan to set the panning of the audio input. If you’re inputting a stereo audio source, you will normally set the inputs to L000 and R127 respectively.
6. Use Level to adjust the level of the audio input. Normally you will leave this at 127.
7. FX Control Bus sends the output of the timbre to an FX Control bus.

Use this when you want the audio input to an effect to be controlled by another sound. There are two FX Control buses, which gives you a great deal of freedom for controlling effects freely. (See PG p.575 “4. FX Control Bus”)

8. REC Bus sends the audio input to a REC bus.

In the P0– Audio Input/Sampling page, you can choose a REC bus as the Sampling Setup Source Bus so that the signal sent to the REC bus can be sampled or recorded (only in Sequencer mode).

- ⚠ Noise can enter the OASYS via these buses; see “Avoiding extraneous noise” on page 99.

⚡ If you want to save the edited settings in the OASYS, you must write them. Use the Global mode page menu command **Write Global Setting** to do this.

9. If you want to use the Global mode Input settings in the other modes, check the “Use Global Setting” option.

If you want to make independent settings for programs, combinations, and songs, uncheck this setting.

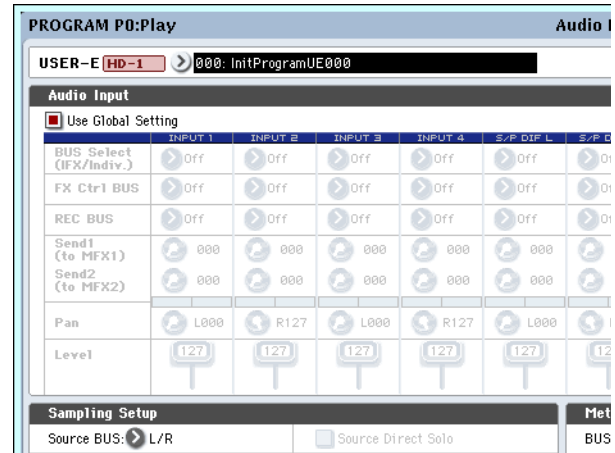

Dynamic modulation, MIDI/Tempo Sync, and Common FX LFO

Dynamic modulation (Dmod)

Dynamic modulation (Dmod) lets you use MIDI messages or the OASYS’s controllers to modulate specific effect parameters in real-time.

For more information, see “Dynamic Modulation Sources (Dmod)” on page 976 of the Parameter Guide.

Dmod Example

As an example, let’s set up dynamic modulation to control an effect parameter in realtime.

1. As described in the procedure for “Program Effects settings” on page 185, set IFX1 to 091: L/C/R BPM Delay. Verify that you’re hearing a delay effect.
2. Go to the Program P8: Insert Effect– IFX1 page.

Using Dmod to change the delay level via the Joystick

3. Set Input Level Dmod to +100.
4. Set Source to JS+Y: CC#01.

The delay sound will disappear.

The input level to the effect can be controlled by the joystick. As you move the joystick away from yourself, the delay sound will gradually increase.

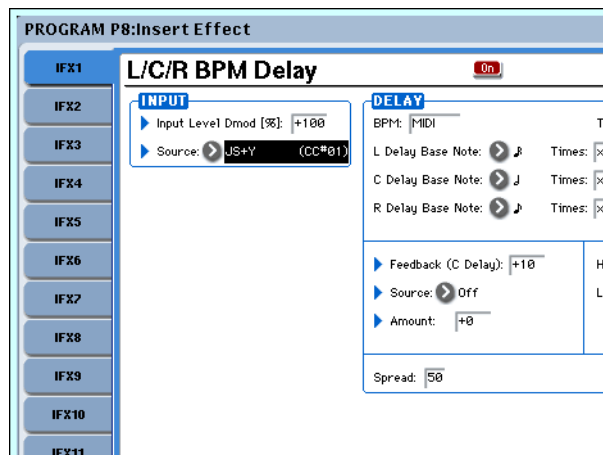

Using Dmod to change the feedback level via SW1

5. In the P1: Basic/Vector– Set Up Controllers page, set the SW1 function to SW1 Mod.CC#80, and the Mode to Toggle.
6. Choose P8. Set the Feedback Source to SW1 Mod. (CC#80), and set Amount to +30.

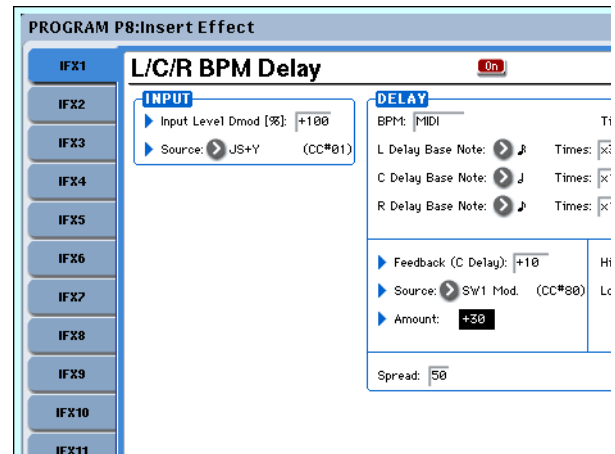

When you move the joystick away from yourself and press the SW1 switch, the feedback level will increase, and the delay sound will continue for a longer time. The **Amount** setting specifies the feedback level that will be in effect when the SW1 switch is pressed. If **Amount** is set to -10, pressing the SW1 switch will reduce the feedback level to 0.

MIDI/Tempo Sync

MIDI/Tempo Sync lets you synchronize effects LFOs and delay times to the system tempo. For more information, see “Tempo Synchronization” on page 729 of the Parameter Guide.

Using the MIDI/Tempo Sync function to synchronize the delay time to KARMA tempo changes.

1. Set up the effects as described under “Dmod Example” on page 191.
2. Set BPM to MIDI.

3. For L, C, and R, set the Delay Base Note and Times as desired.

For this example, set **Delay Base Note** to ♩ and **Times** to x1 so that the effect will be easily understandable. The delay time will repeat at an interval of a 8th note.

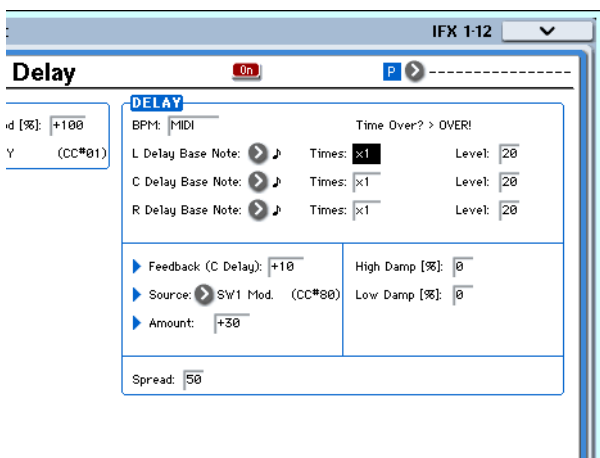

4. Rotate the TEMPO knob, and the delay time will change.

When you (push the joystick away from yourself and) press the SW switch, the feedback level will rise, and the delays will become longer.

5. When you turn on the KARMA ON/OFF switch, KARMA will begin playing.

Select any desired KARMA GE. When you rotate the TEMPO knob, the delay time will change in synchronization with the changing tempo of the KARMA.

Depending on the specific delay effect, you may hear a noise if you change the tempo while the delay is sounding. This is because the delay sound becomes discontinuous, and is not a malfunction.

For some effects, you can synchronize the LFO frequency to the tempo. Set the effect parameters **MIDI/TEMPO Sync** to On, and **BPM** to MIDI. For more information, see “Tempo Synchronization” on page 729 of the Parameter Guide.

Common FX LFO

Two Common FX LFOs are available for modulation effects, such as choruses, filters, phasers, etc. In the P8-Common FX LFO page of Program, Combination, Sequencer, or Sampling modes, you can specify the reset conditions and speed of Common FX LFO 1 and 2.

Normally, the LFOs of two or more modulation-type effects used simultaneously will not have synchronized phase even if you set them to the identical Frequency, since the LFOs are being generated independently.

However if you select Common 1 or Common 2 for the **LFO Type** parameter of a modulation-type effect, the effect will use not its own individual LFO but the Common LFO you specify here. This allows you to use a single Common FX LFO to simultaneously control two or more modulation-type effects such as flanger, phaser, or auto-pan with the same phase. Since you can

make independent settings for LFO waveform and phase offset for each effect, you are free to create complex combinations of effects.

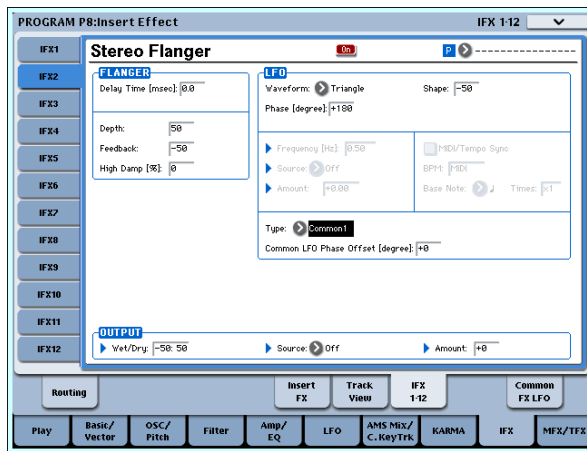
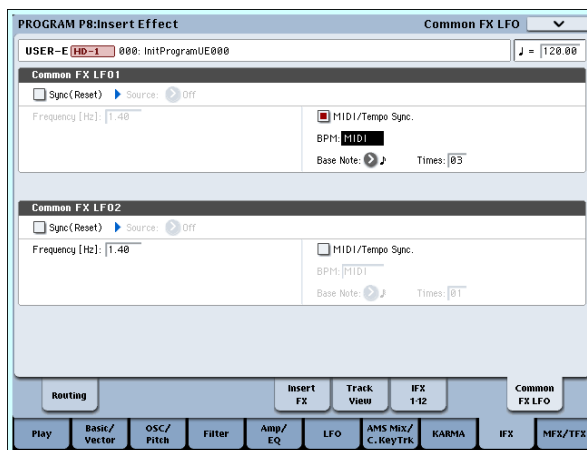
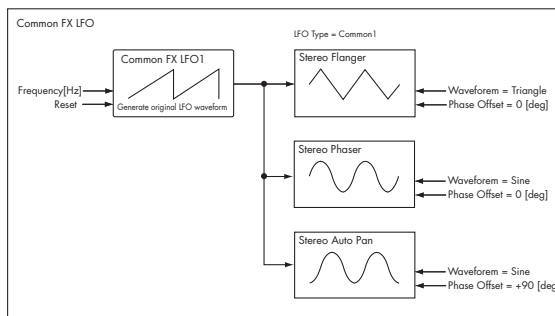

Using KARMA

Overview - What is KARMA?

KARMA stands for Kay Algorithmic Realtime Music Architecture, named after its inventor, Stephen Kay.

The KARMA function generates MIDI data, using many different algorithms seamlessly integrated to provide a powerful “music generation engine.” Based on the notes and chords you play, KARMA generates phrases and patterns in real-time, generating not just notes but MIDI control data as well. The KARMA architecture allows the various algorithms to be reconfigured and varied in realtime, as you play them.

For example, you can create the dynamic tempo changes that occur within a harp glissando, the synchronized changes in volume and tone that occur as part of a brass phrase, the randomness within a drum phrase, the crescendo and diminuendo of a fill-in, changes in phrase or tone of a techno groove, complex interweaving phrases that would be impossible to play on a keyboard, guitar strumming and finger-picking simulations with natural-sounding changes, and backing grooves that follow your keyboard playing in realtime – all under your control. KARMA lets you produce phrases and patterns at a far more musical and flexible level than conventional arpeggiators or pattern playback functions.

On the OASYS, the KARMA function is designed to work in close conjunction with the numerous other functions, giving you unbelievable performance power on stage or in the studio.

The structure of the KARMA function

The KARMA function consists of the following major parts.

KARMA modules

A KARMA module uses a GE (Generated Effect) to create a phrase or pattern.

In Program mode, only one KARMA module (A) is used. In Combination or Sequencer modes, four KARMA modules (A, B, C, D) can be used. For

example, each module might be used to generate phrases and patterns for a separate sound, such as drums, bass, guitar, and piano.

MIDI In Program mode, the KARMA module transmits and receives all MIDI data on the Global MIDI channel specified by “MIDI Channel.”

In Combination and Sequencer modes, the MIDI data from each KARMA module is transmitted and received on the “Input Channel” and “Output Channel” specified for each module.

GE (Generated Effect)

The phrases and patterns produced by a KARMA module are created by a GE (Generated Effect).

Based on note data from the keyboard, the GE uses various internal parameters to control how the note data will be developed, and how rhythm, chord structure, and velocity etc. will be controlled to generate a phrase or pattern. MIDI control changes and pitch bend data can also be generated in synchronization with the phrase or pattern. As a capability unique to the OASYS, the KARMA function can generate MIDI exclusive messages to control wave sequencing, which switches between multisamples etc. of a program in realtime. This lets you create phrases and patterns in which the tone color and note pitches change independently.

The OASYS provides a large number of GEs that can be used for a variety of instruments, performance techniques, and musical styles.

GE RTP – Real Time Parameters

A GE consists of over two hundred internal parameters. In each GE, up to 32 of these internal parameters are pre-selected as the most suitable parameters for use in controlling the phrase or pattern. These parameters are called the “GE realtime parameters.”

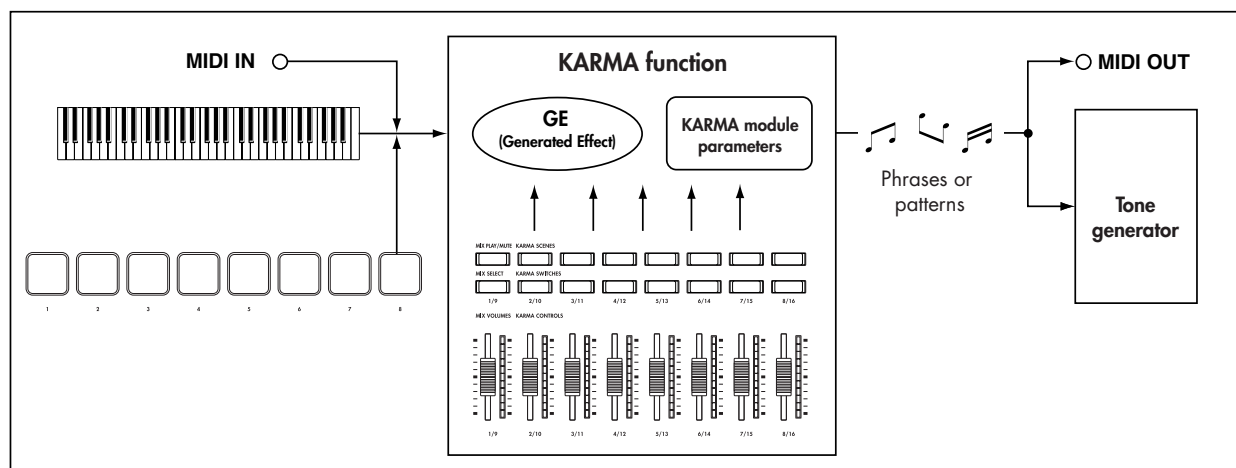

You can control the phrase or pattern by editing these parameters, or by assigning them to the KARMA CONTROLS sliders or KARMA SWITCH buttons and operating these during your performance.

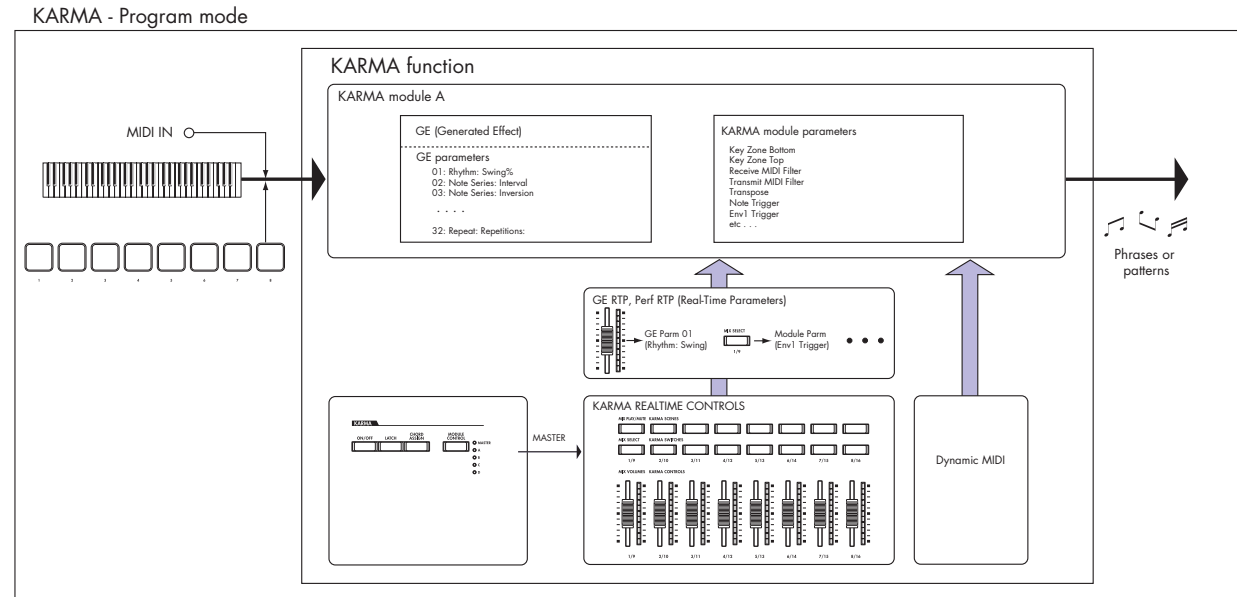

KARMA - Combination/ Sequencer mode

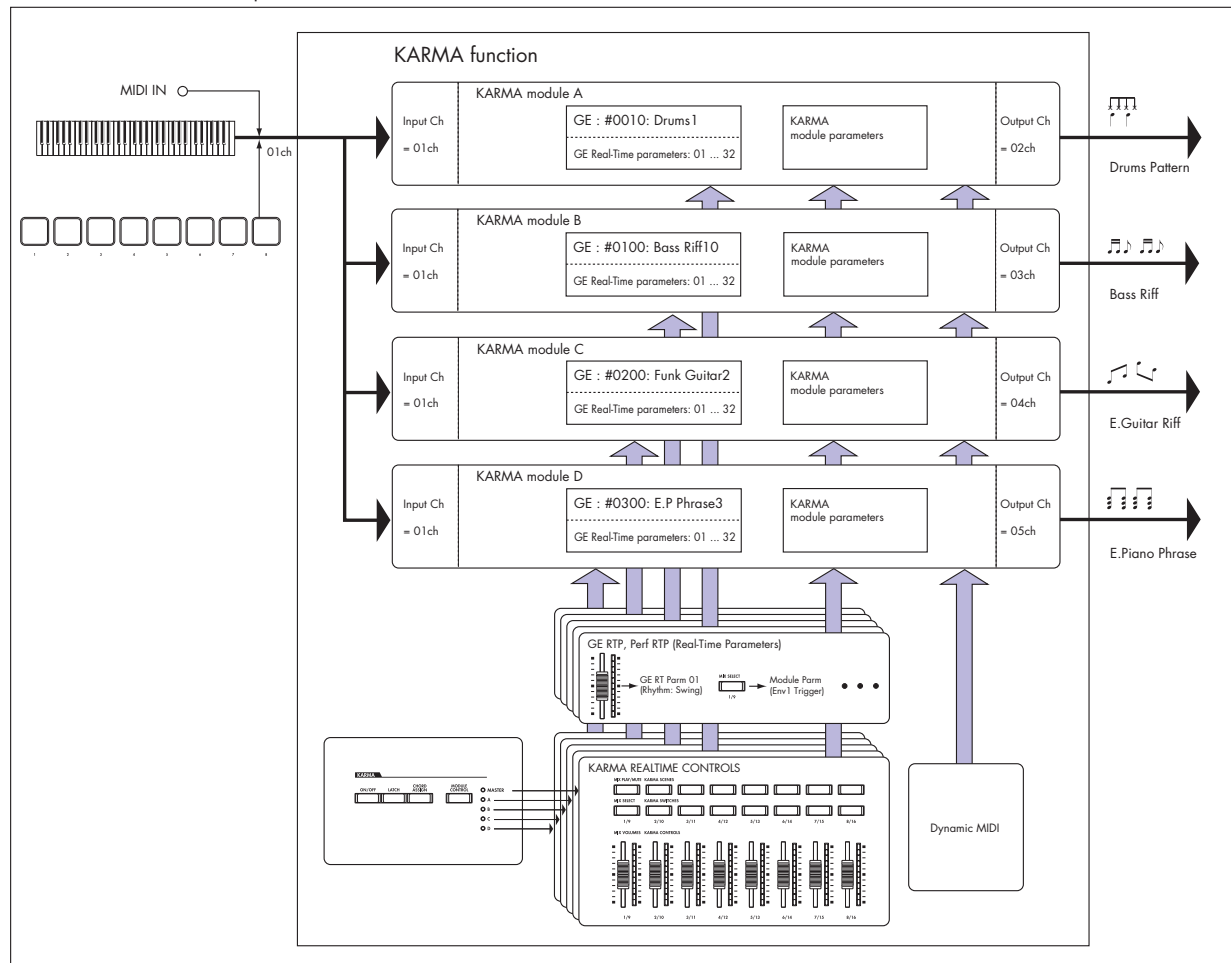

RTC Model

All of the preset GEs have an internally-specified RTC Model. The RTC Model is a certain standardization of the more than two hundred internal parameters of the

GE, based on the type and purpose of that GE.

GEs for which the same RTC Model has been specified will (by default) have the same parameters assigned as their GE realtime parameters. This means that even if

you're switching through various GEs that have the same RTC Model, you will be able to control them in a uniform manner and make valid comparisons between them, since their default state will be the same. Of course, you are free to edit the GE realtime parameters.

In the pre-loaded programs and combinations, the KARMA CONTROLS sliders and switches are assigned in a uniform manner depending on the RTC Model for the GE used by each module. For example if a KARMA module used by a program or combination uses a GE of the Drum/Percussion category, the KARMA REALTIME CONTROLS sliders and KARMA SWITCHES will be assigned so that Slider 1 controls the swing and Slider 2 controls the pattern variation. Of course, you are also free to edit the REALTIME CONTROLS assignments.

Each GE is assigned one of the following RTC Models.

- DP1 - Drum/Perc
- BL1 - Bass/Lead
- DM1 - Drum Melodic
- GV1 - Gated Vel/Pattern
- GC1 - Gated CCs
- CL1 - Comp/Lead
- WS1 - WaveSeq 1
- WS2 - WaveSeq 2
- EG1 - Dual Env Gen
- LF1 - Dual LFOs
- MR1 - Melodic Repeat
- MB1 - Mel Rpt/Bend
- RB1 - Real-Time Bend
- Custom - a few GEs may require special RTC setups, outside of the normal RTC Models. In this case, the assignment of RTC Controls is left up to the sound designer of the specific Program or Combination.

An example is 2028: VJS Motion. If you load this GE, it clears all RTC Model assignments (when the GE Load Options are set to the default setting). With such GEs, it's generally best to copy the Module from an existing Program, so that you have an example of how to map the controls.

Auto RTC Setup

This is a convenient function that automatically makes KARMA CONTROLS sliders and KARMA SWITCH assignments according to the RTC Model setting of a GE. Use the Load GE Options dialog box to make these settings automatically. Here you can choose whether you want KARMA controller assignments to be made automatically when you use the GE Select parameter to select a GE. If you've chosen "Auto RTC Setup" in this dialog box, the assignments will be made automatically each time you change the GE. This means that regardless of the type of GE that's selected, you will immediately be able to use the standard KARMA CONTROL assignments. (See PG p.7)

KARMA module parameters

These are the parameters that control the phrases and patterns generated by a KARMA module.

You can set these parameters independently for each KARMA module. These parameters include the GE selection, MIDI input/output channel, key zone, MIDI filtering, and triggering.

GE RTP (GE Real-Time Parameters) Perf RTP (Perf Real-Time Parameters)

These are the parameters that you can control via the KARMA CONTROLS sliders or KARMA SWITCHES.

If GE realtime parameters (GE RTP) and KARMA module parameters (Perf RTP) are assigned to the KARMA CONTROLS sliders and KARMA SWITCHES, you'll be able to control them in realtime to modify the phrase or pattern while you play.

Dynamic MIDI

Dynamic MIDI is a function that uses the OASYS' controllers or MIDI control messages to control specific functions of the KARMA function.

For example, this enables you to use the joystick to play strummed guitar chords, use a foot switch to control the Run/Mute status of a KARMA module, or use the damper pedal to latch a KARMA module. You'll be able to control them in realtime while you play.

KARMA CONTROLS

These are front panel controls used to control the KARMA function. The settings of these controls can be saved independently for each program, combination, and song (see "KARMA" on page 12).

ON/OFF switch

This switches the KARMA function on/off.

LATCH switch

If this is on, the phrase or pattern will continue playing even after you remove your hand from the keyboard or pads 1-8.

CHORD ASSIGN switch

Use this to assign single notes or chords to pads 1-8 (See p.19).

MODULE CONTROL switch

In Combination or Sequencer mode, this selects the module that will be controlled by the KARMA sliders 1-8, KARMA SWITCHES 1-8, and KARMA SCENE switches 1-8.

MASTER: Choose this setting if you want to control modules A, B, C, and D simultaneously. For example, this lets you use slider 1 to control the GE realtime parameter Swing for all modules A, B, C, and D.

A, B, C, D: Choose one of these settings if you want to control the corresponding module individually.

Note: In Program mode only MASTER can be selected, and module A will be controlled.

KARMA CONTROLS sliders 1–8

KARMA SWITCHES 1–8

KARMA SCENES 1–8

When CONTROL ASSIGN is set to R.TIME KNOBS/KARMA, these control the KARMA module(s) selected by MODULE CONTROL.

By operating these controls, you can adjust GE realtime parameters and KARMA module parameters to freely vary the phrases or patterns generated by the KARMA module. (Use “GE RTP, Perf RTP” to specify the parameter that each control will affect.)

SCENE switches

These switches let you store the settings of sliders 1–8 and switches 1–8 as eight different “scenes” (SCENE 1–8). In Combination or Sequencer modes, scenes can

store separate settings for each module, and you can use the MODULE CONTROL switch and the Scene Matrix function to control this.

For more information, see “7–5d: Module Control Scene Matrix” on page 384 of the Parameter Guide.

Pads 1–8

Pads 1–8 are velocity-sensitive pads that respond to the force with which you strike them. When you strike a pad, the assign note or chord (up to eight notes with a velocity setting) will play. You can use the pads in many ways, such as using them to play drum sounds, to trigger sampled sounds, or as chord pads to trigger the KARMA function.

In the pre-loaded programs and combinations, the pads are assigned effective chords. You can use the CHORD ASSIGN switch to easily assign your own chords.

Performing with KARMA

Based on your keyboard playing or on the note data received from MIDI IN, the KARMA function automatically generates a diverse variety of phrases or patterns, such as guitar or keyboard backing riffs, bass phrases, or drum patterns. You can use the KARMA CONTROLS sliders and the KARMA SWITCHES to freely modify these phrases or patterns.

The OASYS contains pre-loaded programs and combinations that take full advantage of the KARMA function, covering a wide range of instruments, playing techniques, and musical genres. In these programs and combinations, the parameters most useful for controlling the KARMA function have been assigned to the KARMA CONTROLS sliders and KARMA SWITCHES.

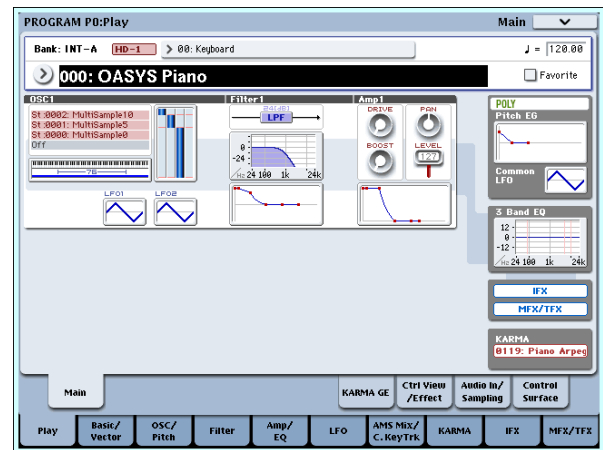

Performing with KARMA in Program mode

In Program mode you can use one KARMA module to generate a phrase or pattern appropriate for the sound of the program.

Selecting a Program and switching KARMA on/off

1. Press the PROGRAM switch to enter Program mode, and select the desired program. (See “Selecting Programs by bank and number” on page 1.)

As you step through the programs, you’ll find some programs for which the KARMA ON/OFF switch LED is lit.

Press a key or a pad 1–8, and the KARMA function will begin playing.

In other programs as well, you can press the ON/OFF switch (LED lit) to turn the KARMA function on.

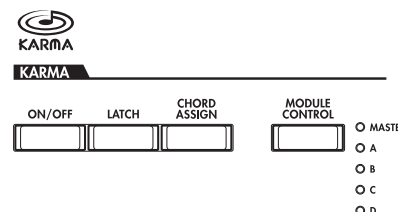

Adjusting the performance tempo

1. You can use the TEMPO knob or the TAP TEMPO switch to adjust the performance tempo.

This will change the “♩=” value located in the upper right of the display. You can adjust the tempo in a range of 40.00–240.00. The LED located above the TAP TEMPO switch will blink at intervals of a quarter note (♩).

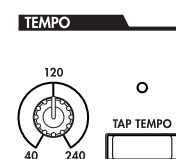

As an alternative to using the TEMPO knob or the TAP TEMPO switch, you can choose “♩=” in the display, use numeric keys 0–9 to enter the tempo, and then press the ENTER switch. You can also use the VALUE controller to set the tempo. The LED will blink at the tempo you specify.

Note: The setting of the TEMPO knob is also saved when you write a program.

- ⚡ If the Global P1: MIDI-MIDI page “MIDI Clock” parameter is set to External, or set to Auto and MIDI Clock messages are being received, the display will indicate “♩= EXT, and the OASYS will be synchronized to an external MIDI device. In this case, you won’t be able to change the tempo by operating the OASYS.

Checking note-on/off and key zone

The screen shown below is a realtime display of the note data received from the keyboard, pads 1–8, and MIDI IN, and the note on/off data generated by the KARMA module, together with the name of the chord that was detected.

1. Access the Program P0: Play– KARMA GE page.

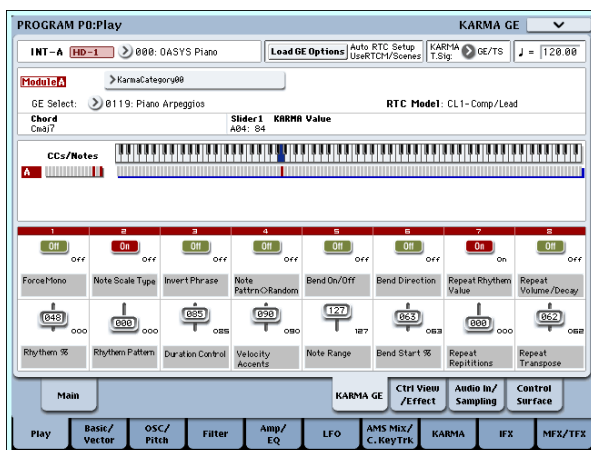

When you play the keyboard or strike a pad 1–8, the name of the chord detected by the KARMA module will appear in the “Chord” field of KARMA Module Info.

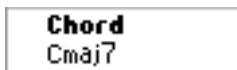

The CCs/Notes area shows the key zone of the KARMA module, and the state of the control data and note on/off data generated by the KARMA module. (See “Specifying the keyboard zone for the KARMA function” on page 203)



Using the KARMA controllers

Note: The state of the KARMA controllers is saved when you write the program.

KARMA function on/off: ON/OFF switch

The KARMA function will turn on/off each time you press the ON/OFF switch. If it is on, the switch LED will light. When you play the keyboard or pads 1–8, the GE selected for the KARMA module will start generating a phrase or pattern.

Using the pads: pads 1–8

When you press a pad 1–8, the assigned chord (up to eight notes with a velocity setting) will play, and the KARMA function will start generating a phrase or pattern. Effective chords are already assigned for the pre-loaded programs. You can play the pads together with the keyboard.

Assigning a chord to a pad: CHORD TRIGGER ASSIGN switch

You can assign a chord to each pad 1–8. For each pad, you can assign up to eight notes with a velocity setting. You can do this using either of the following two ways.

Method 1:

1. Press the CHORD ASSIGN switch.

The CHORD ASSIGN switch LED will light.

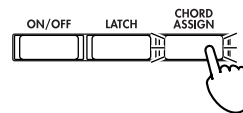

2. Play a note or chord on the OASYS’ keyboard.



Note: If you want to input a complex chord that you’re unable to play at once, you can hold down one note and use your other hand to add the remaining notes one by one.

3. Press one of the pads 1–8.

The note or chord you played in step 2 will be assigned to the pad, and the CHORD ASSIGN switch LED will go dark.

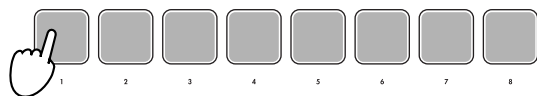

4. Press the pad to which you assigned a note or chord.

The KARMA function will start playing according to the note or chord you assigned.

Method 2.

1. Play a note or chord on the OASYS’ keyboard.



2. Press the CHORD ASSIGN switch.

The CHORD ASSIGN switch LED will light.

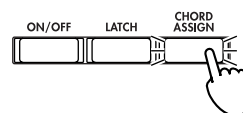

3. Press one of the pads 1–8.

The note or chord you played in step 1 will be assigned to the pad, and the CHORD ASSIGN switch LED will go dark.

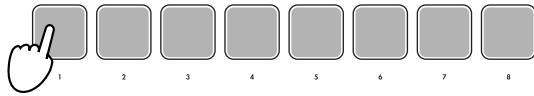

4. Press the pad to which you assigned a note or chord.

The KARMA function will start playing according to the note or chord you assigned.

Making the performance continue after you remove your hand from the keyboard or pads 1–8: LATCH switch

You can make the KARMA function continue playing even after you remove your hand from the keyboard or pads 1–8.

LED lit: Latch is on. The performance will continue even after you remove your hand from the keyboard or pads 1–8.

LED dark: Latch is off. The performance will stop when you remove your hand from the keyboard or pads 1–8.

Modifying the phrase or pattern generated by the KARMA module: KARMA CONTROLS 1–8 sliders, KARMA SWITCHES 1–8, SCENE 1–8 switches

Parameters useful for controlling the phrase or pattern are already assigned to the KARMA CONTROLS 1–8 sliders, KARMA SWITCHES 1–8, and SCENE 1–8 switches. You can operate these controllers to create a wide range of changes in the phrase or pattern that's playing.

1. Access the Program P0: Play– KARMA GE page.

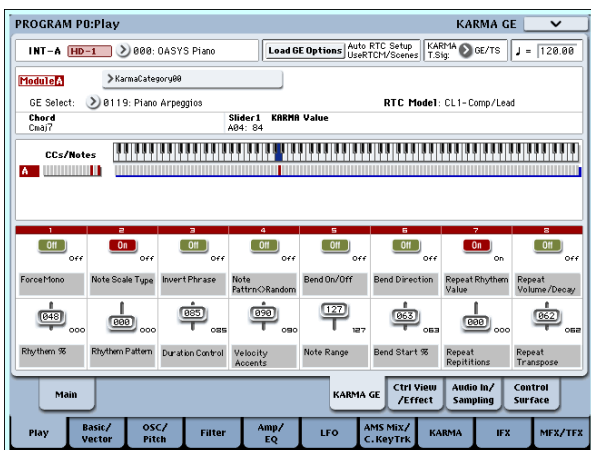

The lower part of the display shows the names of the sliders and switches that are assigned in this program. In the pre-loaded programs, the KARMA CONTROLS sliders and KARMA SWITCHES have already been assigned.

2. Operate the front panel KARMA CONTROLS 1–8 sliders and KARMA SWITCHES 1–8.

The pattern or phrase will change accordingly.

You can also turn the switches on/off by pressing them in the display. You can operate the sliders by selecting them and then using the VALUE controller to adjust the value.

The type or value of the parameter being controlled by the sliders and switches is shown in the KARMA Module Info “KARMA Value” field. This lets you see how the parameters are being affected by your slider or switch operations.



The saved value is shown at the lower right of each slider or switch.

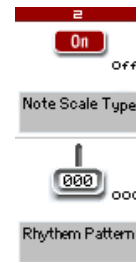

3. Use the front panel SCENE 1–8 switches to choose a scene.

The sliders and switches will change to the settings that were saved in the scene you chose.

Each of the eight scenes contains the values of sliders 1–8 and switches 1–8. By pressing a SCENE 1–8 switch to choose a scene, you can instantly recall settings for the eight sliders and eight switches.

Even if you switch scenes, the changes you make using sliders 1–8 and switches 1–8 are remembered until you select another program. When you write a program, your slider and switch settings are saved in the respective scene 1–8.

Restoring the state of the sliders and switches

You can do this by adjusting the controls while you watch the sliders and switches in the screen, or you can use the following method.

Restoring the entire program

1. Press the COMPARE switch.

The entire program will revert to the state in which it was written. (See “Using COMPARE” on page 54.)

2. Press the COMPARE switch once again.

The program will return to the edited state.

Restoring all sliders and switches of the selected scene

1. Operate the sliders and switches to edit the values saved in the program.

The LED of the selected SCENE switch will blink.

2. Hold down the RESET CONTROLS switch, and press the SCENE switch.

All sliders and switches will be reset to their stored settings, and the SCENE switch LED will light.

3. Once again, hold down the RESET CONTROLS switch and press the SCENE switch.

All sliders and switches will return to the edited state of step 1, and the SCENE switch LED will blink.

Restoring a single slider or switch

1. Operate the sliders and switches to edit the values saved in the program.
2. Hold down the RESET CONTROLS switch, and operate the slider or switch that you want to restore.

The selected slider or switch will return to its stored setting.

Restoring all scene settings

1. In each scene, operate the sliders and switches to edit the values saved in the program.
2. Hold down the RESET CONTROLS switch, and press the MODULE CONTROL switch.

All scenes will return to their stored settings.

- ⚡ If you've used the RESET CONTROLS switch to return all scenes to their original setting, there is no way to return to the edited settings of step 1.

Resetting the REALTIME CONTROL knob settings for all scenes

1. Use the REALTIME CONTROL knobs to edit the sound of the program, and use the sliders and switches to modify the saved settings in each scene.
2. Hold down the RESET CONTROLS switch, and press the CONTROL ASSIGN R.TIME KNOBS/KARMA switch.

The Real-Time Controls knob settings will be reset (to the center value of 064), and the settings of all scenes will return to their stored settings.

- ⚡ If you've used the RESET CONTROLS switch to reset the Real-Time Controls knobs and to return all scenes to their saved setting, there is no way to return to the edited settings of step 1.

Selecting a GE (Generated Effect)

When the KARMA function is on, the KARMA module uses a GE to generate phrases or patterns. The OASYS provides a wide range of GEs that you can use for a variety of instruments, playing techniques, and musical styles (See "The structure of the KARMA function" on page 193).

For each of the pre-loaded programs, a GE that's appropriate for the sound of the program is already selected. If you switch to a different GE, the generated phrase or pattern will change dramatically.

1. Access the Program P0: Play- KARMA GE page.

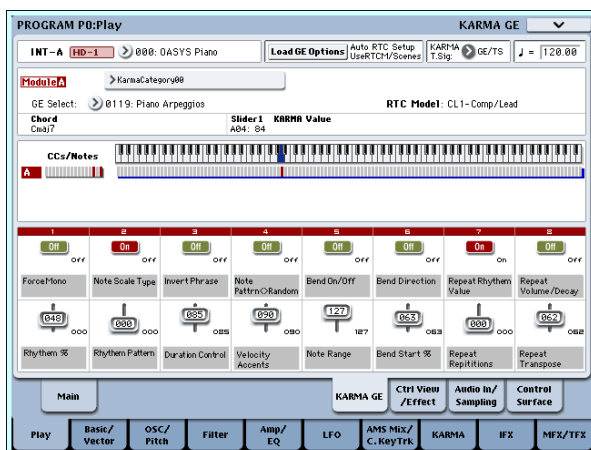

2. In the display, press the "GE Select" popup button to access the "GE Select" menu.

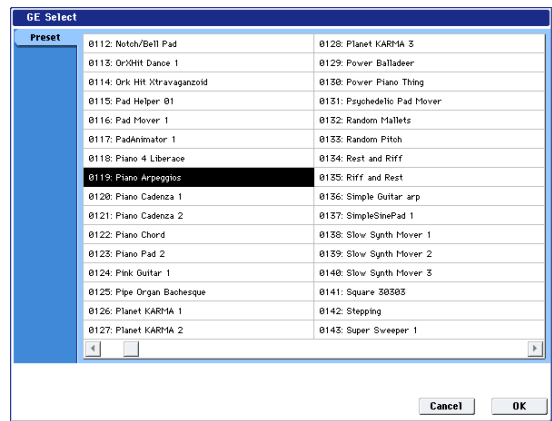

3. Select a GE from the list in the right side of the display.

The selected GE will be highlighted and will become active.

If you now play the keyboard, this GE will generate a phrase or pattern.

While this menu is displayed, you can select and play these GEs without pressing the OK button.

4. If you are satisfied with the program you selected, press the OK button to close the menu.

Alternatively, you can select a GE by choosing "GE Select" in the display, and operating the VALUE slider or VALUE dial. You can also use "GE Category Select" to choose a GE by category. (See "GE Category Select" on page 8 of the Parameter Guide.)

Editing KARMA module parameters

For details on editing the parameters of a KARMA module, see "KARMA function settings" on page 202.

Performing with the KARMA function in Combination mode

In Combination mode, up to four KARMA modules can be operating simultaneously. You can use the four KARMA modules together with the sixteen timbre programs in a wide variety of ways, for example by using them to independently play phrases and patterns for separate programs such as drums, bass, guitar, and strings.

Selecting a combination and turning the KARMA function on/off

1. Press the COMBI switch to enter Combination mode, and select the desired combination. (See "Selecting combinations" on page 2.)

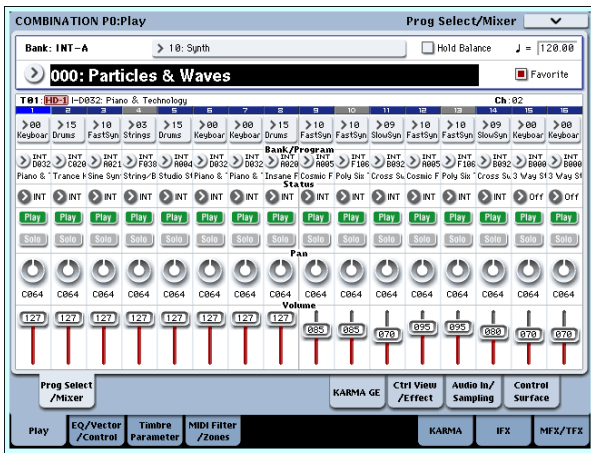

As you step through the combinations, you will notice that the KARMA ON/OFF switch LED is lit for some combinations. With these combinations, the KARMA function will begin playing when you play the keyboard or pads 1–8. Even for other combinations, you can press the KARMA ON/OFF switch (LED lit) to turn on the KARMA function.

Adjusting the performance tempo

In the same way as for a program, you can use the TEMPO knob or the TAP TEMPO switch to adjust the performance tempo. Changing the tempo will affect the tempo of all KARMA modules that are operating. (See p.196)

You can't adjust the performance tempo of each KARMA module individually.

Checking note-on/off and key zone

The screen shown below is a realtime display of the note data received from the keyboard, pads 1–8, and MIDI IN, and the note on/off data generated by KARMA modules A, B, C, and D, together with the name of the chord that was detected.

1. Access the Combination P0: Play– KARMA GE page.

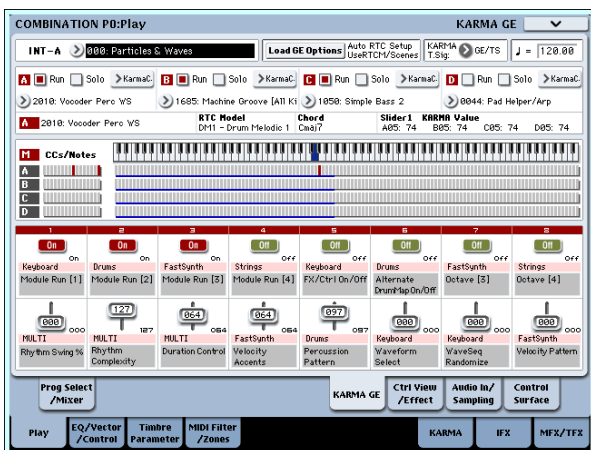

When you play the keyboard or strike a pad 1–8, the name of the chord detected by each KARMA module will appear in the “Chord” field of KARMA Module Info.

The displayed chord name is the chord that is detected by the module selected by the front panel MODULE CONTROL switch. The way in which chords are detected will depend on the settings of the KARMA module.



The CCs/Notes area shows the status of the control data and note-on/off data generated by KARMA modules A, B, C, and D, and the key zone settings of the KARMA modules.

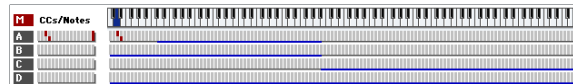

Note: Chord detection is affected by the KARMA module’s key zone settings (Combination 7–1b), “Transpose” (Combination 7–3b: Module Parameter-Control), and Dynamic MIDI “Destination” (Combination 7–8) Chord Scan and Smart Scan.

Using the KARMA controllers

You can operate the KARMA controllers to control the phrase or pattern generated by each KARMA module. In Combination mode, you can choose the KARMA module that you want to control.

Note: The state of the KARMA controllers is saved when you write the combination.

1. Access the Combination P0: Play– KARMA GE page.

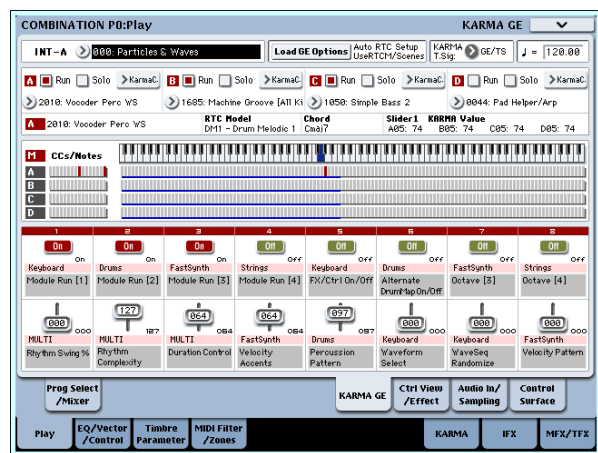

The lower part of the display shows the names of the sliders and switches that are assigned in this combination.

In the pre-loaded combinations, the KARMA CONTROLS sliders and KARMA SWITCHES have already been assigned.

2. Use the front panel MODULE CONTROL switch to select the module that you want to control. If you select MASTER, you will be controlling all four KARMA modules simultaneously. If you select A–D, you will be controlling the corresponding KARMA module.
3. Operate the front panel KARMA CONTROLS 1–8 sliders and KARMA SWITCHES 1–8.

The sliders and switches will control the pattern or phrase generated by the KARMA module selected by the MODULE CONTROL switch. If you've selected MASTER, you'll be able to control the module on/off status and vary the patterns and phrases generated by all of the KARMA modules.

You can also operate the sliders and switches in the display or using the VALUE controller, just as in Program mode.

The KARMA module and the type or value of the parameter being controlled by the sliders and switches is shown in the KARMA Module Info "KARMA Value" field. This lets you see the KARMA module and parameters that are being affected by your slider or switch operations.

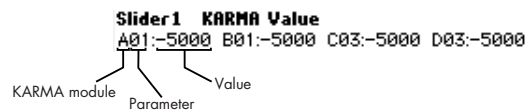

4. Use the front panel SCENE 1-8 switches to choose a scene.

This changes the scene for the KARMA module(s) selected by the MODULE CONTROL switch.

If MODULE CONTROL is set to MASTER, each KARMA module will change to the scene that is saved as the master setting.

Each of the eight scenes contains the values of sliders 1-8 and switches 1-8. By pressing a SCENE 1-8 switch to choose a scene, you can instantly recall settings for the eight sliders and eight switches.

Even if you switch scenes, the changes you make using sliders 1-8 and switches 1-8 are remembered until you select another combination. When you write a combination, your slider and switch settings are saved in the respective scene 1-8.

Name display for the KARMA CONTROLS 1-8 sliders and KARMA SWITCHES 1-8

Just as in the equivalent page of Program mode, the Combination P0: Play- KARMA GE page displays the sliders and switches assigned to the combination, and their names.

In the combination, the name shown in square brackets [] is the category of the program selected for the timbre being controlled by the KARMA CONTROLS 1-8 sliders and KARMA SWITCHES. This tells you the timbre whose phrase is being controlled by the KARMA CONTROLS 1-8 sliders and KARMA SWITCHES.

If multiple timbres are being controlled simultaneously, this will indicate [MLTI].

KARMA module "Run" and "Solo" settings

In Combination mode, up to four KARMA modules can be operating simultaneously.

If the KARMA function is off, all KARMA modules will be stopped. If the KARMA function is on, the KARMA module(s) you specify here will operate.

1. Access the Combination P7: KARMA- GE Setup/Key Zones page.

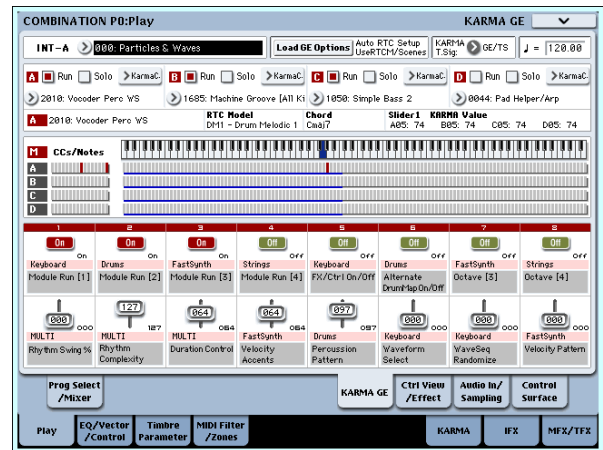

2. Use the "Run" and "Solo" settings to specify the module(s) that will operate when KARMA is on.

KARMA modules whose "Run" setting is On (checked) will operate.

If you turn "Solo" On (checked), only that KARMA module will sound. This is useful when you are selecting a GE, or when you want to audition the phrase that a module is generating.

Modules whose "Solo" is On (checked) will sound even if "Run" is Off (unchecked).

⚠ The "Solo" setting is cleared when you switch to another combination. It is not saved when you write the combination.

KARMA module A will sound.



KARMA module B will sound.



KARMA modules A and B will sound.



Note: If " Run " is not shown in the display, "Run" has been assigned as a performance realtime performance. The KARMA SWITCHES etc. will control "RUN."

KARMA module MIDI I/O channel settings

The MIDI input/output channel setting for each KARMA module and the MIDI channel setting of each timbre together determine how the KARMA modules will play the timbres.

If a KARMA module's MIDI output channel matches the MIDI channel of a timbre, the phrase or pattern generated by that KARMA module (if it's operating) will play that timbre. For details on making these settings, see "KARMA function settings in Combination mode" on page 206 and "7-1c: MIDI I/O" on page 376 of the Parameter Guide.

GE (Generated Effect) selection

Just as for a program, you can use the “GE Select” field to select the GE used by each module. (See “KARMA function settings in Combination mode” on page 206)

KARMA function settings

This section explains how to make settings for the KARMA function in each mode. For details on how to perform using the KARMA function, see “Performing with KARMA” on page 196.

KARMA function settings in Program mode

In Program mode you can use only one KARMA module (module A). KARMA function settings for a program are made in the various pages of Program P7: KARMA. Here we will explain how to use the major parameters, such as selecting a GE. For other parameters, see “Program P7: KARMA” on page 98 of the Parameter Guide.

Switching the KARMA function on/off

Each time you press the KARMA ON/OFF switch, the KARMA function will be turned on or off. When on, the switch LED will be lit.

The on/off status is saved when you write the program.

Selecting a GE

Here’s how to select the GE used by the KARMA module.

1. Access the Program P7: KARMA– GE Setup/Key Zones page.

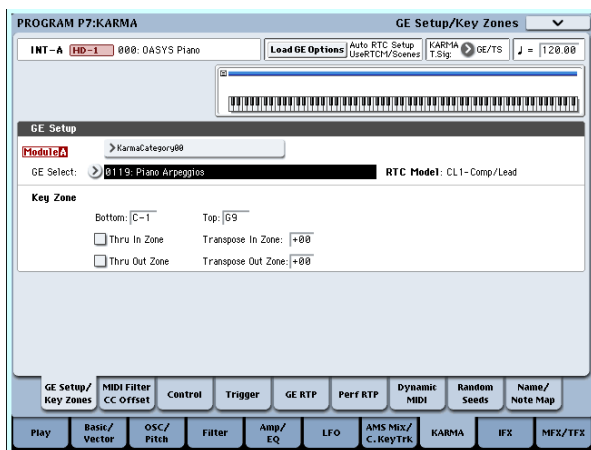

2. Press “Load GE Options” to access the dialog box, turn Auto RTC Setup on, and check the User RTC Model and Reset Scenes options.

KARMA module parameter settings

For details on editing KARMA module parameters, see “KARMA function settings in Combination mode” on page 206.

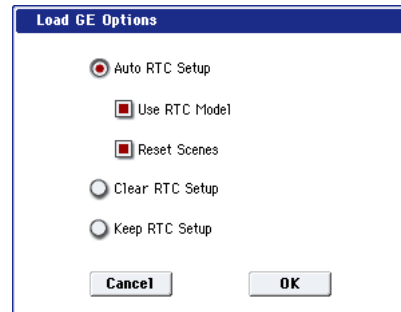

“Load GE Options” specifies whether the settings of the KARMA CONTROLS sliders and KARMA SWITCHES settings will be automatically set, initialized, or maintained when you select a GE.

In this example, we’ve opted to automatically set the slider and switch functions to the standard settings for the RTC Model of the selected GE, so that you’ll be able to control the phrase or pattern immediately.

3. Use “GE Select” to select the GE used by the KARMA module.

Use “Tempo” to set the tempo of the pattern or phrase generated by the GE.

Use “KARMA T.Sig” to specify the time signature of the pattern or phrase generated by the GE. If you select GE/TS the time signature specified by the GE will be used; with any other setting, the time signature will change temporarily.

The OASYS provides numerous preset GEs that can be used for a wide range of instruments, playing techniques, and musical styles.

“Category Select” shows the category of the GE that’s selected for the KARMA module. All GEs are organized by category. You can press “Category Select” to open the Category/GE Select screen, and choose a GE by category and sub-category (see “GE Category Select” on page 8 of the Parameter Guide).

Copying KARMA function settings from another program

You can use the “Copy KARMA Module” page menu command to copy the KARMA function settings (EG selection, KARMA module parameter settings, etc.) from another program.

1. Press the page menu button to open the page menu, and choose “Copy KARMA Module.”

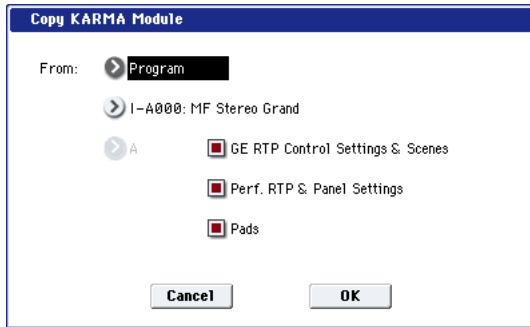

2. Specify the copy-source mode, bank, and number.

If you want to copy the GE realtime parameter settings and scene settings from the copy-source program, choose the “GE RTP Control Settings & Scenes” option (checked).

If you want to copy performance realtime parameters settings and front panel settings from the copy-source program, choose the “Perf. RTP & Panel Settings” option (checked).

If you to copy the pad settings from the copy-source program, choose the “Pads” option (checked).

3. Press OK to execute the copy, or press Cancel if you decide to cancel.

Specifying the keyboard zone for the KARMA function

Here’s how to specify the zone of keys that will trigger the KARMA function. For example you might make settings so that the keys at the bottom of the keyboard will trigger phrases, and keys above this range can be played normally.

- 1. Access the Program P7: KARMA– GE Setup/Key Zones page. (See the diagram in step 1 of “Selecting a GE”)**
- 2. Use the Key Zones Bottom and Top to specify the key zone.**

Keys you press and note data received from MIDI IN that falls within this range will be sent to the KARMA module.

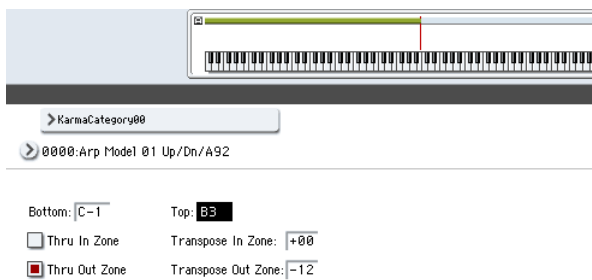

In the example shown above, the notes from C-1 through B3 are being input to the KARMA module. When you play B3 or a lower note, the KARMA function will generate a phrase or pattern.

- 3. If “Thru In Zone” and “Thru Out Zone” are on (checked), the notes you play on the keyboard will play in addition to the phrase or pattern generated by the KARMA function.**

These two fields are the settings for inside and outside the key zone.

You can use “Transpose In Zone” and “Transpose Out Zone” to transpose the notes played on the keyboard in semitone steps.

In the example shown above, the B3 and lower keys will control only the phrase or pattern generated by the KARMA function, and the C4 and higher keys will be used for manual playing on the keyboard.

Use “Transpose Out Zone” to adjust the pitch of the manually-played region.

KARMA module MIDI filtering and CC offset

- 1. Access the Program P7: KARMA– MIDI Filter/CC Offset page.**

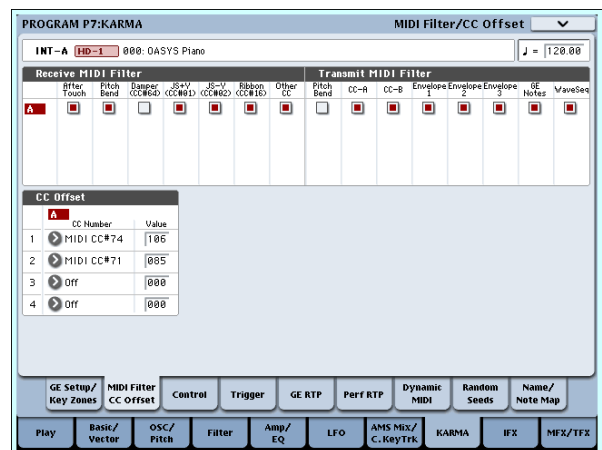

Receive MIDI Filter

This specifies whether filtering will be applied to the MIDI control data received by the KARMA module. If an item is on (checked), the corresponding data will be received.

When the KARMA function is on, MIDI control data received by the KARMA module is sent directly to the tone generator. If this setting is off (unchecked), that data will not be sent to the tone generator.

In the example shown above, damper pedal messages are enabled when the KARMA function is off, and disabled when it is on.

Transmit MIDI filter

This specifies whether filtering will be applied to the MIDI control data generated by the GE selected for the KARMA module. If an item is on (checked), transmission is enabled.

Normally you will leave these items on. If you don’t want to use the pitch bend or other control change data generated by the selected GE, turn these items off (unchecked).

In the example shown above, pitch bend data generated by the GE will not be transmitted.

CC Offset

Use this if you want to control the effects or the sound of the program while the KARMA function is on. For example, you might use this to decrease the brightness of the sound or raise the resonance of the sound in conjunction with the phrase that’s being generated. Alternatively, you might use this to

control effects, for example by turning on a delay effect in conjunction with a generated phrase.

Use “CC Number” to specify the MIDI control change number. Choose one of the CC numbers in the 70’s which control the sound, or an AMS or Dmod source (see “7–2c: CC Offset” on page 102 of the Parameter Guide).

In the example shown in the preceding page, CC#74 and CC#71 are controlling filter cutoff and resonance level.

KARMA module parameters

In the Program P7: KARMA– Module Parameters–Control and Trigger pages you can edit KARMA module parameters.

Here we will describe how to edit the most frequently-used parameters. For details on the other parameters, refer to “7–3a: Program Name and Tempo” on page 103 of the Parameter Guide.

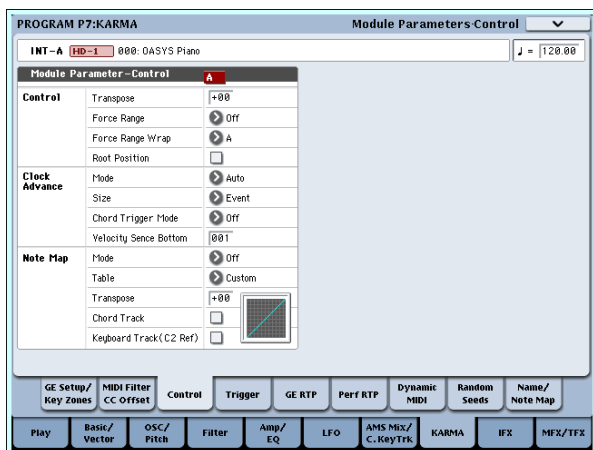

Control – Transpose

This lets you transpose the note data being input to the KARMA module in semitone steps. This will control the pitch of the phrase or pattern generated by the KARMA module. For example if you want to lower a bass phrase by one octave, set this to –12.

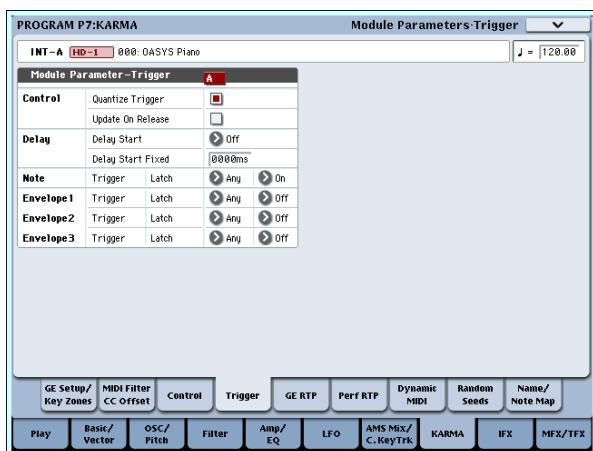

Control – Quantize Trig (Quantize Triggers)

This quantizes the timing of the triggering produced by the note data. (See “Synchronizing the KARMA function” on page 213)

Off (unchecked): Triggering will occur the moment you play the key.

On (checked): Trigger timing will be quantized to 16th note intervals relative to the base tempo.

Note – Trigger

This specifies the triggering conditions for the phrase or pattern generated by the GE. Try these out and see how they differ.

Any: Triggering will occur each time you play a key, and the phrase or pattern will play from the beginning.

AKR: Triggering will occur only the first time you play a key after having released all notes on the keyboard.

1st: Triggering will occur only at the first note you play after turning on the KARMA function.

Dyn: Playing the keyboard will not cause triggering. Triggering will occur when you operate the controller specified by Dynamic MIDI.

GE Real-Time Parameters

Here you can edit the GE realtime parameters that are selected by the KARMA module. You can also assign GE realtime parameters to the KARMA CONTROLS sliders and KARMA SWITCHES so that you can use them to control the phrase or pattern in realtime while you perform.

Note: If you use the Auto RTC Setup function of “Load GE Options,” the standard slider and KARMA SWITCH assignments for the RTC Model of that GE will automatically be made when you select a GE. (See “Selecting a GE” on page 202)

1. Access the Program P7: KARMA– GE Real-Time Parameters page.

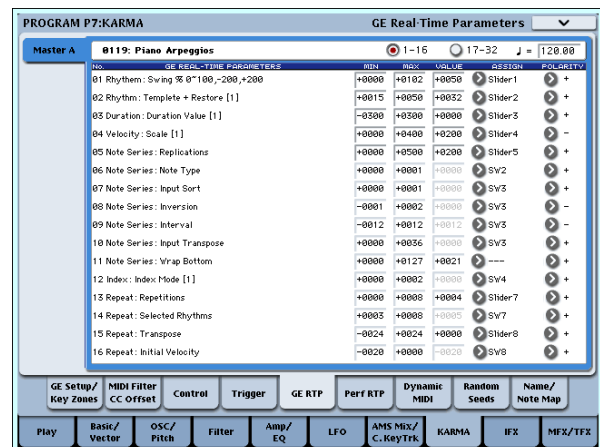

Use “GE RTC Select” to switch the set of GE realtime parameters you want to see.

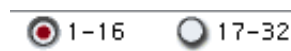

These buttons display GE realtime parameters 1–16 or 17–32.

The number and type of GE realtime parameters you can edit here will differ depending on the selected GE. (There will be a maximum of 32.) In each GE, the parameters most useful for controlling the phrase or pattern are provided as presets.

Note: RTC Model: Every GE contains an internal setting that indicates its RTC Model. Based on the type or purpose of the GE, the RTC Model provides

a certain degree of standardization to the over 200 internal parameters of the GE. By default, GEs that have the same RTC Model will be preset with the same GE realtime parameters.

2. Use “VALUE,” “MIN,” and “MAX” to specify the value, minimum value, and maximum value of each GE realtime parameter.

When you select a GE, the default parameter values that are preset for that GE will be assigned.

The values you assign here are controlled as follows by the KARMA CONTROLS you specify in the “ASSIGN” field.

Slider 1–8	000-064-127 =MIN-VALUE-MAX
Slider 1–8 (SW)	000-063 = MIN, 064-127 = MAX
SW 1–8	Off = MIN, On = MAX
DynaMIDI 1–8	Depending on Dynamic MIDI setting

3. Use “ASSIGN” to assign each GE realtime parameter to the desired controller.
4. Use Polarity to specify the polarity of control.

+: Control the parameter as shown in the table above.

–: The relationship of MIN and MAX will be inverted. For example as you move a slider from 000 to 127, the value will be controlled from the MAX value to the MIN value.

Perf RTP (Perf Real-Time Parameters)

Here’s how KARMA parameters such as KARMA key zone and KARMA module parameters (i.e., KARMA parameters other than GE realtime parameters) can be assigned to controllers.

If you’ve assigned these parameters to KARMA CONTROLS, you’ll be able to control them in realtime while you perform (see “Control Surface knobs, sliders, & switches” on page 47, and “7–6b: Perf Real-Time Parameters” on page 112 of the Parameter Guide).

1. Access the Program P7: Perf Real-Time Parameters page.

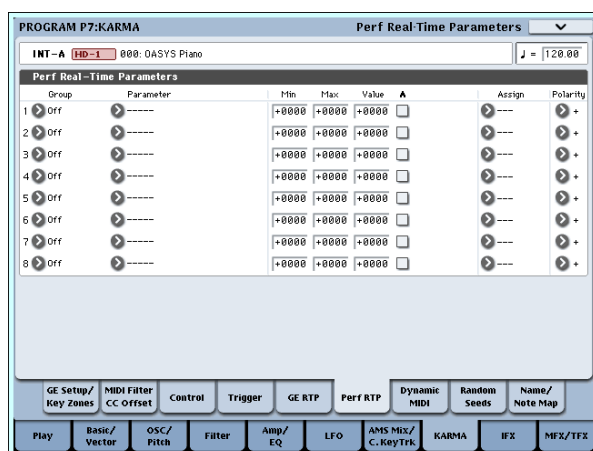

As an example, we’ll show how you can use a KARMA CONTROLS slider to control the KARMA module parameter “Transpose.”

2. Use “Group” and “Parameter” to select the parameter you want to control.

For this example, set “Group”: Mix, and “Parameter”: Transpose. Turn “A” on (checked) so that the slider will control KARMA module [A].

3. Specify the range and value that you want to control.

The setting of the parameter will be assigned by default (–12 in this example), as described under “7–3b: Module Parameter-Control” on page 103 of the Parameter Guide.

For this example, set “Min,” “Max,” and “Value” to –24, +0, and –12 respectively.

4. Use “Assign” to assign the desired controller.

For this example, we’ll assign Slider 1.

5. Use Polarity to specify the polarity of control.

For this example, specify “+”.

When you set CONTROL ASSIGN to R.TIME KNOBS/KARMA and operate slider 1, the Transpose setting will change in semitone steps over a range of –24 to +0, with –12 as the center value.

Note: If you set “Parameter” to Transpose Octave, the change will occur in steps of one octave over a range of –24 to +0, with –12 as the center value.

If you select Transpose Octave/5th, the change will occur in alternating steps of an octave or a fifth, over a range of –24 to +0 with –12 as the center value. For example if this parameter is at the Min setting and a C3 note is sounding, moving slider 1 from 000 toward 127 will cause a pitch change of C3 → G3 → C4 → G4 → C5.

Dynamic MIDI setting

Dynamic MIDI lets you use an OASYS controller or a MIDI control message to control a specific parameter of the KARMA function. You can specify up to eight controllers (Source) and what they will do (Destination). For more information, see “Dynamic MIDI Sources & Destinations” on page 984 of the Parameter Guide.

Naming the KARMA RTC sliders 1–8 and switches 1–8

1. Access the Program P7: KARMA– Name/Note Map page.

Here you can select names for the KARMA CONTROLS sliders and KARMA SWITCHES. You can save these settings independently for each program. The OASYS provides suitable preset names for the KARMA CONTROLS sliders and KARMA SWITCHES.

Note:

Auto Assign KARMA RTC Name

An appropriate name for each KARMA CONTROLS slider and KARMA SWITCH will be determined based on the GE RTP or Perf RTP being controlled, and will be assigned automatically. (See “Auto Assign KARMA RTC Name” on page 139 of the Parameter Guide.)

Linking KARMA settings to Program changes

KARMA settings can be saved individually for each Program. Normally, when you select a new Program, its KARMA settings will be loaded as well. In some cases, however, you may wish to try out different Programs while keeping the KARMA settings the same.

The Global Basic page **Load KARMA Settings when changing** parameters let you select between these two behaviors. There are separate settings for Programs, Combis, and Songs. To set this up:

1. Go to the **Global Basic** page.
2. Under “Load KARMA setting when changing”, set the “Programs” check-box as desired.

Check the box to load the individual Programs’ KARMA settings.

Un-check the box to keep KARMA settings the same, even when changing Programs.

For more information, see “Load KARMA settings when changing” on page 643 of the Parameter Guide.

KARMA function settings in Combination mode

In Combination mode (and Sequencer mode) you can use four KARMA modules (modules A, B, C, and D). In a combination, you can use the four KARMA modules and the sixteen timbre programs in a variety of ways; for example, separate phrases or patterns can play programs such as drums, bass, guitar, and strings.

KARMA function settings for a combination are made in the various pages of Combination P7: KARMA. Here we will explain the procedure for setting the major parameters, such as “Run” and “Solo” settings, the selection of a GE, and MIDI I/O settings. For other parameters, see “Editing the parameters of each KARMA module” on page 208. and “7–1b: GE Setup/Key Zones” on page 376 of the Parameter Guide.

Switching the KARMA function on/off

Each time you press the KARMA ON/OFF switch, the KARMA function will be turned on or off. When on, the switch LED will be lit.

The on/off status is saved when you write the combination.

When the KARMA function is off, all KARMA modules A, B, C, and D will be off. When the KARMA function is on, the KARMA modules will operate as specified by their “Run” and “Solo” settings.

“Run” and “Solo” settings

1. Access the **Combination P7: KARMA– GE Setup/Key Zones** page.

Note: Alternatively, you can make these settings in the **Combination P0: Play– KARMA GE** page.

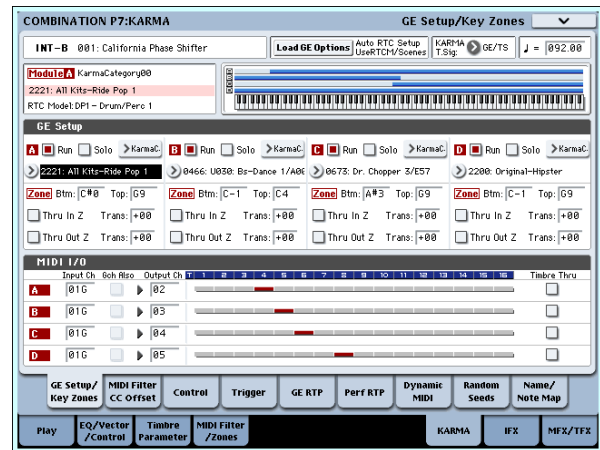

2. Use “Run” and “Solo” to select the module(s) that will operate when the KARMA function is on.

For more information, see “0–6b: GE Select” on page 328 of the Parameter Guide.

Note: For the preloaded combinations, when the MODULE CONTROL switch is set to MASTER, KARMA SWITCHES 1, 2, 3, and 4 will switch “Run” on/off for modules A, B, C, and D.

Selecting a GE

Here’s how to select the GE used by each KARMA module. (See “KARMA function settings in Program mode” on page 202)

1. Access the **Combination P7: KARMA– GE Setup/Key Zones** page.

Note: Alternatively, you can make these settings in the **Combination P0: Play– KARMA GE** page.

2. Press “Load GE Options” to access the dialog box, turn **Auto RTC Setup** on, and check the **User RTC Model and Reset Scenes** options.

“Load GE Options” specifies whether the settings of the KARMA CONTROLS sliders and KARMA SWITCHES will be automatically set, initialized, or maintained when you select a GE.

For this example, we’ll choose to set the slider and switch functions for KARMA modules A, B, C, and D to the standard settings for the RTC Model of the selected GE, so that you’ll be able to control the phrase or pattern immediately.

3. Use “GE Select” to select the GE used by the KARMA module.

Use “Tempo” to set the tempo of the pattern or phrase generated by the GE.

Use “KARMA T.Sig” to specify the time signature of the pattern or phrase generated by the GE. If you select GE/TS the time signature specified by the GE for each module will be used; with any other setting, the time signature of all GEs will change temporarily.

MIDI I/O channel settings

You can specify the MIDI input and output channels for each of the four KARMA modules used by a combination.

The MIDI input/output channel setting for each KARMA module and the MIDI channel setting for each timbre will determine the routing that specifies

how the KARMA modules play the timbres. These are the most important settings when using multiple KARMA modules in a combination.

1. Access the Combination P7: KARMA- GE Setup/Key Zones page.

2. Specify the “Input Channel” and “Output Channel” of each KARMA module.

“**Input Channel**”: For a combination, you will normally set this to Gch so that your keyboard playing will control the KARMA module.

“**Output Channel**”: Set this to the MIDI channel of the timbre(s) that should be played by this KARMA module.

Gch Also: This option is available if Input Channel is set to other than Gch. If you select (check) this option, a module that would normally be triggered only by the Input Channel will also be triggered by the Gch. (Gch, Global 1-1a)

Timbre Thru: If this option is on (checked), timbres differing from the global MIDI channel will sound when the KARMA function is off.

Setting example 1:

This example shows how the “Gch Also” option works.

1. Set MIDI Channel for the following timbres as follows.

- Timbre 1: G ch
- Timbre 2: 2 ch
- Timbre 3: 3 ch
- Timbre 4: 4 ch
- Timbre 5: 5 ch

2. Set the MIDI channels for the pads as follows.

- Pad 1: MIDI channel = 2 ch
- Pad 2: MIDI channel = 3 ch
- Pad 3: MIDI channel = 4 ch
- Pad 4: MIDI channel = 5 ch

3. For each KARMA module, set “Input Channel” and “Output Channel” as follows.

- KARMA module A: “Input Ch” = 2 ch, “Out Ch” = 2 ch
- KARMA module B: “Input Ch” = 3 ch, “Out Ch” = 3 ch
- KARMA module C: “Input Ch” = 4 ch, “Out Ch” = 4 ch
- KARMA module D: “Input Ch” = 5 ch, “Out Ch” = 5 ch

4. Turn the KARMA function off.

When you play the keyboard, timbre 1 will sound. When you strike pads 1-4, timbres 2-5 will sound.

5. Turn the KARMA function on.

When you play the keyboard, timbre 1 will sound. When you strike pads 1-4, KARMA modules A-D will each trigger a different GE which will play phrases or patterns on timbres 2-5.

6. For KARMA module A, turn “Gch Also” on (checked).

7. Turn off the KARMA function.

When you play the keyboard, timbre 1 will sound.

When you strike pads 1-4, timbres 2-5 will sound.

8. Turn on the KARMA function.

When you play the keyboard, timbre 1 will sound. KARMA module A for which you turned “Gch Also” on (checked) will trigger its GE and play a phrase or pattern on timbre 2.

When you strike pads 1-4, KARMA modules A-D will trigger their respective GEs and play phrases or patterns on timbres 2-5.

Setting example 2:

This example shows how the “Timbre Thru” option works.

Select a piano program for timbre 1, a bass program for timbre 2, and a drum program for timbre 3.

We’ll play timbre 1 manually from the keyboard. KARMA module A will be used to play a bass phrase on timbre 2, and KARMA module B to play a drum phrase on KARMA module B. (Make sure that the global MIDI channel is 01.)

1. Set the MIDI Channel for timbres 1, 2, and 3.

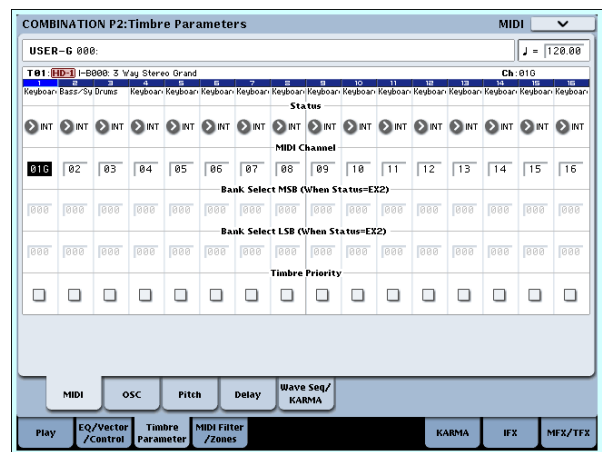

For this example, set timbre 1 to 01, timbre 2 to 02, and timbre 3 to 03. Since each timbre is set to a separate channel, the KARMA module set to the corresponding channel will play only that timbre.

2. Set the “Input Channel” and “Output Channel” of each KARMA module as follows.

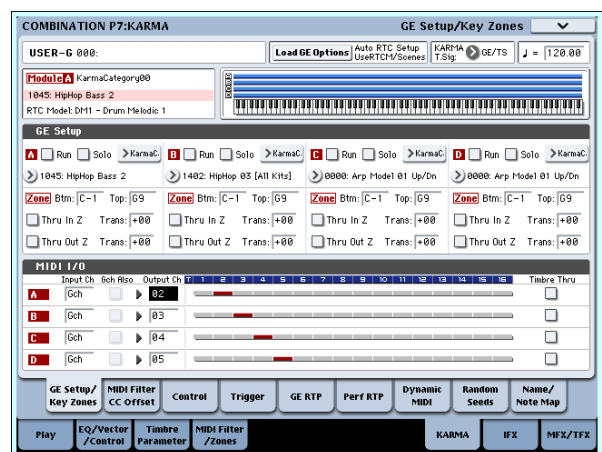

KARMA module A: “Input Ch” = G ch, “Out Ch” = 02

KARMA module B: "Input Ch" = G ch, "Out Ch" = 03

The timbres played by the KARMA modules are shown in red, as specified by the timbre's MIDI channel setting and the KARMA module's Out Channel setting.

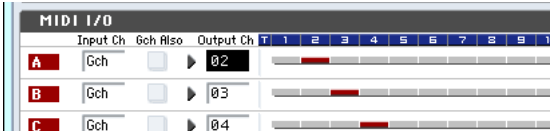

- For KARMA modules A and B, turn "Run" on (checked), and set "GE Select" to GE. (See "Run" and "Solo" settings" on page 206.)

KARMA module A: select a bass phrase as the GE
 KARMA module B: select a drum phrase as the GE
 When the KARMA function is on, your playing on the keyboard will sound a piano on timbre 1, and will simultaneously be sent to KARMA modules A and B.

The bass phrase generated by module A is sent on MIDI channel 02 to play timbre 2.

The drum phrase generated by module B is sent on MIDI channel 03 to play timbre 3.

- Use "Timbre Thru" to specify what will sound when the KARMA function is off.

When the KARMA function is off, playing the keyboard will normally sound only the timbres that match the global MIDI channel (Ch 01).

In this example, this will be the piano sound produced by timbre 1 (Ch 01).

If "Timbre Thru" is on (checked), you'll be able to play timbres that differ from the global channel when the KARMA function is off.

For KARMA module A, turn "Timbre Thru" on (checked). When the KARMA function is off, playing the keyboard will sound the piano of timbre 1 (Ch 01) as well as the bass of timbre 2 (Ch 02).

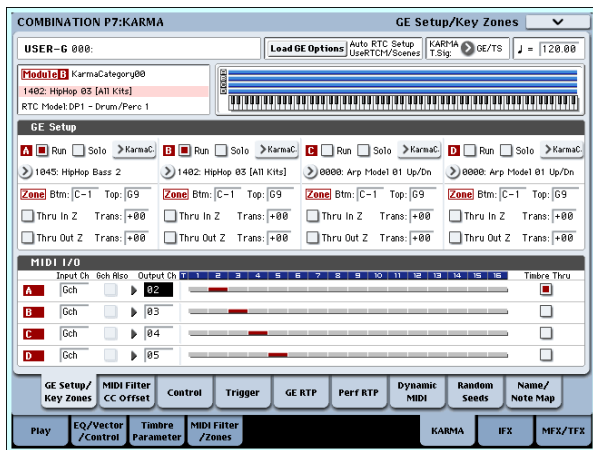

Editing the parameters of each KARMA module

You can specify the keyboard zone in which each KARMA module operates, make MIDI filter settings, and edit KARMA module parameters. Just as for a program, these parameters can be specified independently for each KARMA module.

GE Real-Time Parameters

Here's how to edit the parameters of the GE selected for each KARMA module.

- Access the Combination P7: KARMA- GE Real-Time Parameters page.

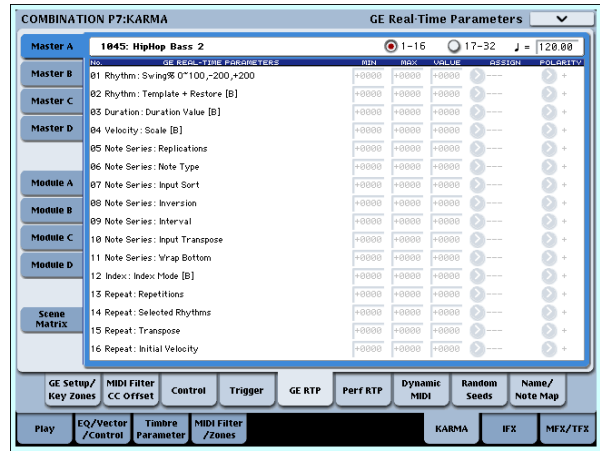

- In the tabs at the left, select Master A.
- Set "MIN," "MAX," "VALUE," "ASSIGN," and "POLARITY."

In the Master tabs, specifying "ASSIGN" lets you edit the "MIN," "MAX," "VALUE," and Polarity settings.

- Make settings in the same way for Master B, C, and D.

The settings you make here are used when MODULE CONTROL is set to MASTER.

Master lets you control any parameters of modules A, B, C, or D. You can also use a single controller to simultaneously control multiple parameters in different modules; for example, you might use Slider 1 to control the "Rhythm: Swing%" parameter of modules A, B, C, and D.

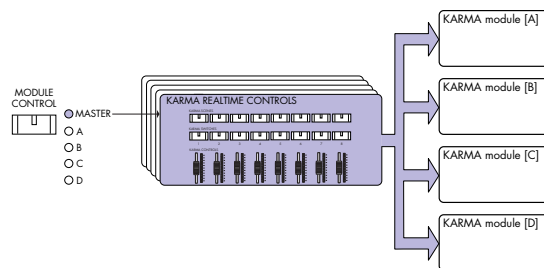

- In the tabs at the left, select Module A.
- Set "MIN," "MAX," "VALUE," "ASSIGN," and "POLARITY."
- Make settings in the same way for Module B, C, and D.

The "ASSIGN" settings for module A, B, C, and D are used when MODULE CONTROL is set to A, B, C, or D respectively.

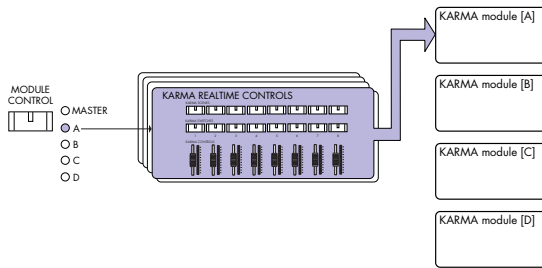

With the appropriate “ASSIGN” settings, a GE realtime parameter of (for example) module A can be controlled independently by Master and Module A. For example you can make settings so that the Swing parameter of a drum GE on module A is controlled in MASTER by slider 1 over a range of 0–50%, and in MODULE A by slider 1 over a range of 50–100%.

Master: 0–50%
Module A: 50–100%

In this case, if you switch MODULE CONTROL between MASTER and A while using slider 1 to control the parameter, the parameter will operate in its last-controlled state. If you set Swing to 0% in MASTER, and then switch to module A, Swing will remain at 0% as long as you don’t move slider 1. However Swing will change once you move slider 1 to control the parameter in the range of 50–100%.

1. Set MODULE CONTROL to MASTER, and set slider 1 to the minimum position. → “Swing” operates at 0%.
2. Change MODULE CONTROL to A. → “Swing” operates at 0%.
3. Move slider 1 to the maximum position. → “Swing” operates at 100%.

The internal settings are automatically controlled so that the phrase being generated does not change abruptly. In the above example when you use MASTER to set “Swing” to 0% and then switch to module A, the displayed indication is 50–100% but the parameter is actually operating at a value of 0%. In this way, you need to be aware that the displayed indication may not match the actual result.

Perf RTP (Perf Real-Time Parameters)

In the same way as for a program, KARMA function parameters other than GE realtime parameters (e.g., KARMA module parameters) can also be assigned to controllers.

These settings are valid when MODULE CONTROL is set to MASTER.

1. Access the Combination P7: KARMA– Perf Real-Time Parameters page.

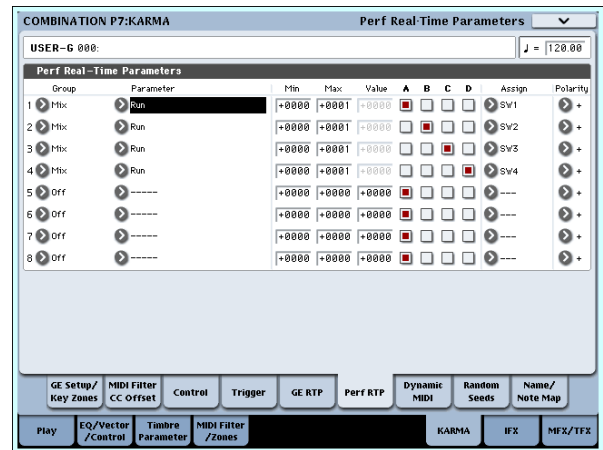

In the same way as for a program, set “Group,” “Parameter,” “Min,” “Max,” “Value,” “Assign,” and “Polarity.” In a combination, you can use the four KARMA modules A, B, C, and D.

Turn on (check) the “A,” “B,” “C,” and/or “D” boxes to select the module(s) you want to control.

In the above example, KARMA REALTIME CONTROLS switches 1, 2, 3, and 4 are controlling the Run/Mute setting of modules A, B, C, and D respectively.

Dynamic MIDI settings

You can make these settings in the same way as for a program. For more information, see “Dynamic MIDI Sources & Destinations” on page 984 of the Parameter Guide.

Naming the KARMA RTC sliders 1–8 and switches 1–8 for MASTER and module A–D

In the same way as for a program, you can select names for the KARMA CONTROLS sliders and KARMA SWITCHES. These settings are saved as part of the combination.

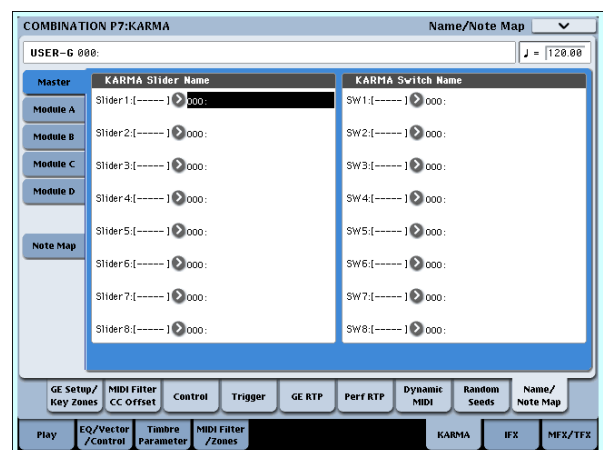

In a combination, the area in square brackets [] automatically shows a portion of the category name of the program selected for each timbre controlled by the KARMA CONTROLS sliders and KARMA SWITCHES. This lets you know the timbre whose phrase is being controlled by each KARMA CONTROLS slider and KARMA SWITCH.

If more than one timbre is being controlled, the area in square brackets will indicate “MLTI.”

Auto Assign KARMA RTC Name (See “Auto Assign KARMA RTC Name” on page 139 of the Parameter Guide)

Specifying the random seeds

For each GE realtime parameter group, you can specify whether the random seed (used to generate random values) will be shared between the four KARMA modules.

1. Access the Combination P7: KARMA– Random Seeds page.

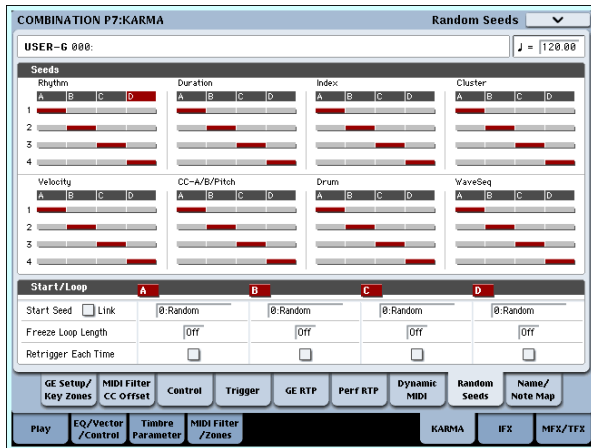

Normally, you will set the four modules to use separate random seeds as shown above; “A”: 1, “B”: 2, “C”: 3, and “D”: 4. If you have selected the same GE for two or more KARMA modules and want them to play in unison using the identical random values, you must select the same random seed for each of these modules. For more information, see “7–8: Random Seeds” on page 388 of the Parameter Guide.

Linking KARMA settings to Combi changes

KARMA settings can be saved individually for each Combination. Normally, when you select a new Combination, its KARMA settings will be loaded as well. In some cases, however, you may wish to try out different Combinations while keeping the KARMA settings the same.

The Global Basic page **Load KARMA Settings when changing** parameters let you select between these two behaviors. There are separate settings for Programs, Combis, and Songs. To set this up:

1. Go to the Global Basic page.
2. Under “Load KARMA setting when changing”, set the “Combinations” check-box as desired.

Check the box to load the individual Combinations’ KARMA settings.

Un-check the box to keep KARMA settings the same, even when changing Combinations.

For more information, see “Load KARMA settings when changing” on page 643 of the Parameter Guide.

KARMA function settings in Sequencer mode

In Sequencer mode you can use four KARMA modules (modules A, B, C, and D). As in a combination, you can use the KARMA modules to generate independent

phrases or patterns that play (for example) drum, bass, guitar, and strings programs, or you can combine the four KARMA modules and the sixteen track programs in a wide variety of ways.

The structure of the KARMA-related parameters is the same as in Combination mode. (See “KARMA function settings in Combination mode” on page 206)

In Sequencer mode, you can use the KARMA function while realtime-recording song tracks or patterns.

The note-on/off data and MIDI control data generated by a KARMA module can be recorded as events in a track or pattern. At this time, you can use the KARMA CONTROLS sliders and KARMA SWITCHES to control the phrase in realtime while you record it.

You can also copy the settings from a combination, and use multi-track recording to realtime-record your keyboard performance.

 Data from the internal sequencer is not input to the KARMA module. Also, you cannot use note data from the internal sequencer to trigger a KARMA module so that it generates phrases etc.

Here we’ll explain how to use the Auto Song Setup function to get started with realtime recording. We will also describe the procedure for realtime recording (single-track recording) using the KARMA function, and for realtime recording (multi-track recording) by copying the settings from a combination.

Auto Song Setup

The Auto Song Setup function automatically copies the settings of a program or combination into a song, and then puts the OASYS in record-ready mode. You can then begin recording immediately just by pressing the SEQUENCER START/STOP switch. This lets you seamlessly move from playing a program or combination into producing a song, so that phrases or ideas for a song that occur to you while using the KARMA function can be immediately turned into a song.

Procedure (using the example of Combination mode)

1. Enter Combination mode.
2. In the Combination P0: Play– Prog Select/Mixer page, select a combination and edit the KARMA RTC parameters etc. as desired.

Note: If you want to keep the edited state of your combination, execute “Update Combination” or “Write Combination.”
3. Hold down the ENTER switch and press the REC/WRITE switch.

The “Setup to Record” dialog box will appear.
4. To execute the Auto Song Setup function, press the OK button. If you decide to cancel, press the Cancel button.

You will automatically move to Sequencer mode, and the settings of the combination will be copied to a song.

The copy-destination song will be the first unused song.

Content copied from a combination

The same content will be copied as when you execute the **Copy From Combi** page menu

command with IFXs, MFXs, and TFXs checked, and **Multi REC Standby** checked. For more information, see “Copy from Combination” on page 526 of the Parameter Guide.

Content that is copied from a program:

The same content will be copied as when you execute the “Copy From Program” page menu command with IFXs, MFXs, and TFXs checked, **To:** set to MIDI Track01, with **KARMA** checked, and **To:** set to KARMA Module A.

5. The OASYS will automatically enter record-ready mode, and the metronome will begin sounding according to the Metronome setting (Sequencer 0-5c).
6. Press the START/STOP switch to begin realtime recording. When you’ve finished recording, press the START/STOP switch once again. (See “Recording MIDI in real-time” on page 85.)

Realtime recording using the KARMA function (single-track recording)

In the following example, we’ll use the KARMA function to record a drum pattern on track 1.

1. Select the desired drum program for track 1 as described in the procedure for realtime-recording a track and for preparing to record (see p.85).

Also make any other necessary settings for recording, such as setting “Track Select” to T01.

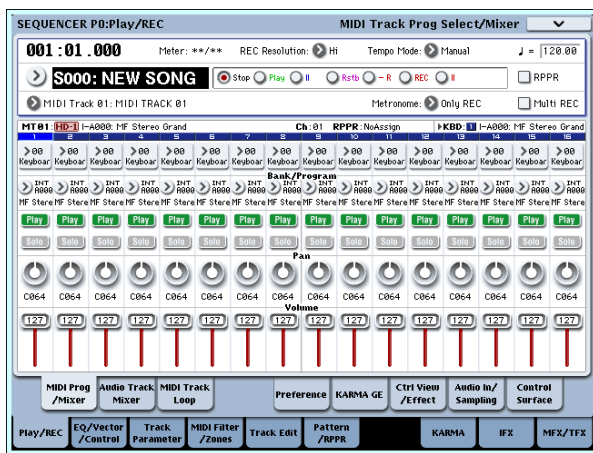

2. Access the Sequencer P7: KARMA- GE Setup/Key Zones page.

Make MIDI I/O settings for the KARMA modules so that KARMA module A will play track 1 (See “KARMA function settings in Combination mode” on page 206).

For KARMA module A, set the “Input Channel” and “Output Channel” to 01 and 01 respectively. Setting them to Tch and Tch will have the same result. For more information, see “7-1c: MIDI I/O” on page 376 of the Parameter Guide.

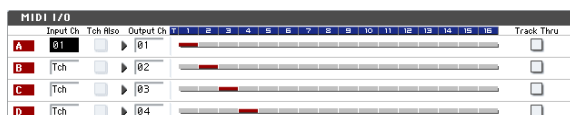

As specified by the MIDI track’s MIDI Channel setting and the KARMA module’s Out Channel

setting, the MIDI track played by the KARMA module is displayed in red.

3. Select a GE for KARMA module A, and set its parameters.

You are free to select a GE and make settings as desired, but in this example we’ll use the “Copy KARMA Module” page menu command to copy all of the program’s KARMA function settings. This is an easy way to set up and record the phrase or pattern that the program’s KARMA function is generating.

1. Use the page menu button located in the top left of the screen to display the page menu, and choose “Copy KARMA Module.”

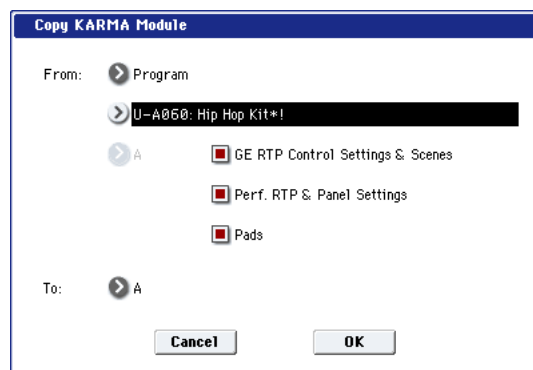

Specify the copy-source program. Turn on (check) “GE RTP Control Settings & Scenes” and “Perf. RTP & Panel Settings.” Press OK to execute the copy.

The settings of the KARMA REALTIME CONTROLS sliders, switches, and scenes will be copied to Module Control A.

2. Press the KARMA ON/OFF switch to turn on the KARMA function.

When you play the keyboard, the KARMA function will generate a drum pattern just as it did for the program.

3. Use the SEQUENCER REC/WRITE switch and the START/STOP switch to realtime-record on track 1. (See “Recording MIDI in real-time” on page 85)

You can operate the KARMA REALTIME CONTROLS sliders/switches and the SCENE switches while recording, and the changes in the pattern or sound that occur will be recorded just as they occur.

⚠ The song tempo and the KARMA function tempo cannot be set independently.

4. If you want the KARMA module to be in synchronization with the sequencer during recording, check the “Quantize Trigger” option.

Access the Sequencer P7: KARMA- Module Parameters-Trigger page.

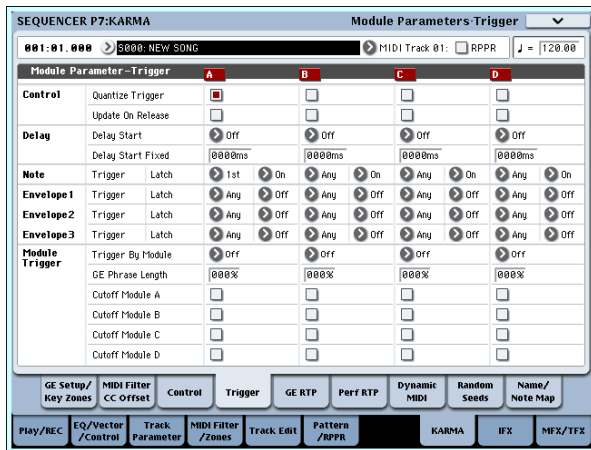

The trigger timing will be synchronized to sixteenth-note intervals of the sequencer beat. (See “Synchronizing the KARMA function” on page 213)

5. You can synchronize the KARMA module to the start timing of the sequencer.
 - While KARMA is running, press the START/STOP switch; the KARMA function will synchronize to the synthesizer timing.
 - If you again press the START/STOP switch, the sequencer and the KARMA function will both stop. If you want to stop only the KARMA function, press the (KARMA) ON/OFF switch to turn it off.
 - If you want the KARMA function to start at the moment recording begins, press the (KARMA) ON/OFF switch to turn it on, and then play the keyboard during the pre-count before recording. The KARMA module will not be triggered immediately, but will be triggered in synchronization with the sequencer when recording begins. (See “Synchronizing the KARMA function” on page 213)

Realtime multi-track recording using settings copied from a combination

The pre-loaded combinations include a diverse array of combinations that take full advantage of the KARMA function. You can play these combinations to stimulate ideas for songs, and record your playing to create basic tracks. Many of these combinations consist of timbres and KARMA modules with differing MIDI channel settings.

In the example below, we’ll show how you can use multi-track recording to record a performance consisting of multiple MIDI channels.

1. We’ll start by copying the settings of a combination into a song. Access the Sequencer P0: Play/REC– MIDI Track Prog Select/Mixer page.
2. In the upper left of the screen, press the page menu button to open the page menu, and choose “Copy From Combination.”



Select the copy-source combination. Turn IFX-All, MFXs, TFXs, and Multi REC Standby on (checked). Press OK to execute the copy.

3. The settings of the combination’s timbres 1–16 will be copied to MIDI tracks 1–16. Effect settings, KARMA settings, and all other common parameters will be copied to the tracks of the song.
4. Choose “Track Select.” Select a track whose MIDI channel matches the global MIDI channel. Press the ON/OFF switch to turn the KARMA function on, and play the keyboard and/or pads to make the KARMA function begin playing in the same way as it did in the copy-source combination. (Depending on the track you selected in “Track Source,” the performance may not be the same as when you were playing the combination. Be sure to select the track whose MIDI channel is the same as the global MIDI channel.)
5. Perform multi-track recording. Make preparations for recording as described in “Multi (multitrack recording)” on page 87. Turn “Multi REC” on (checked).

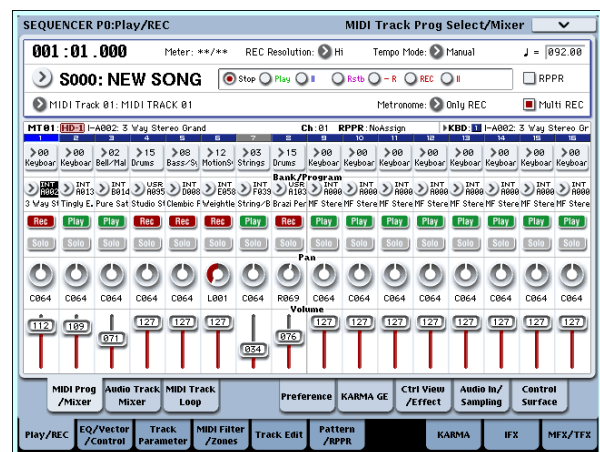

Set the tracks you’re not recording to either Play or Mute. However if you’re recording the performance of a combination, and none of the tracks have already been recorded, it’s ok to leave all tracks set to REC.

6. Press the REC/WRITE switch and then the START/STOP switch to begin realtime recording. (See “Recording MIDI in real-time” on page 85)

While you record, you can operate the KARMA REALTIME CONTROLS sliders, KARMA SWITCHES, and SCENE switches to vary the pattern or sound. The changes you create will be recorded just as you make them.

- The song tempo and KARMA function tempo cannot be set independently.

Synchronizing the KARMA function

Synchronization with a wave sequence

If you want a KARMA module to synchronize with a currently-playing wave sequence (“Mode”= Tempo), turn “Quantize Trigger” on (checked) so that it will synchronize to sixteenth-note intervals of the timing.

The “Quantize Trigger” parameter

The trigger timing of a KARMA module will depend on the setting of its “Quantize Trigger” parameter.

On (checked): The trigger timing of a KARMA module will be quantized to a sixteenth-note interval of the base tempo.

Off (unchecked): The KARMA module will be triggered at the timing at which you play the keyboard.

For more information, see “Quantize Trigger” on page 108 of the Parameter Guide.

Note: If you want a wave sequence to synchronize to the currently-playing KARMA function, go to the P2: Track Parameters Wave Sequence/KARMA page and turn “Wave Sequence Quantize Trigger” on.

Synchronization between KARMA modules A, B, C, and D

In Combination and Sequencer modes, four KARMA modules can be running. Each module has a “Quantize Trigger” setting that determines how that module will synchronize with the other modules.

“Quantize Trigger” Off: The KARMA module will be triggered at the timing at which you play the keyboard. There will be no synchronization between KARMA modules; each will be triggered at their own timing.

“Quantize Trigger” On: The KARMA module will synchronize to sixteenth-note intervals of the timing the first-triggered KARMA module that is currently running.

If you want to simultaneously trigger multiple KARMA modules from the keyboard or pads, turn “Quantize Trigger” on for each of these KARMA modules.

Synchronization with songs, patterns, and RPPR performance in Sequencer mode

If you want a KARMA module to play (or be recorded) in synchronization with the currently-playing song, pattern, or RPPR, turn “Quantize Trigger” on.

“Quantize Trig” Off: The KARMA module will be triggered at the timing at which you play the keyboard. It will not synchronize to the currently-playing song, pattern, or RPPR.

“Quantize Trig” On: The trigger timing of the KARMA module will be quantized to a sixteenth-note interval of the currently-playing song, pattern, or RPPR.

Note: If you want patterns played by RPPR to synchronize to the currently-operating KARMA function, set “Sync” (Sequencer P5: Pattern/RPPR–RPPR Setup page) to SEQ.

Note: If you want a wave sequence to synchronize to the currently-playing song, pattern, RPPR, or the currently-running KARMA function, go to the P2: Track Parameters Wave Sequence/KARMA page and turn on “Wave Sequence Quantize Trigger” as well. For more information, see “Wave Sequence Quantize Trigger” on page 366 of the Parameter Guide.

Synchronization with song start/stop

Synchronization with a song in Sequencer mode

- While the KARMA function is running, pressing the START/STOP switch will synchronize the KARMA function with the sequencer.
The KARMA function will be reset, and the phrases or patterns it generates will start from the beginning.
- While the sequencer is playing and the KARMA function is stopped, and you change the location by pressing the LOCATE switch etc., the KARMA function will be reset, and the phrases or patterns it generates will start from the beginning.
- If you then press the START/STOP switch, the sequencer and the KARMA function will both stop. If you want to stop only the KARMA function, press the (KARMA) ON/OFF switch.
- If you want the KARMA function to start the moment recording begins, press the (KARMA) ON/OFF switch, and then play the keyboard during the pre-count before recording. The KARMA modules will not be triggered immediately, but will be triggered in synchronization with the sequencer the moment recording starts.

Slave operation

Connect the MIDI OUT of your external MIDI device to the OASYS’ MIDI IN.

Set “MIDI Clock” (Global 1–1a: MIDI Setup) to External MIDI. The OASYS will synchronize to MIDI realtime clock and realtime command messages it receives from the connected MIDI device.

Note: If the OASYS is set to MIDI Clock= Auto, it will also synchronize to the external MIDI device in the same way if MIDI realtime clock messages are being received from the external device.

Synchronization to MIDI clock

The KARMA function will synchronize to a tempo based on the external MIDI clock timing.

Synchronization with MIDI realtime commands

In Sequence mode, Song Start, Continue, and Stop messages that the OASYS receives will control song playback and recording just as when you operate the front panel START/STOP switch. The KARMA function also will be controlled in the same way as when you operate the front panel START/STOP switch. (See "Synchronization with song start/stop")

When the OASYS receives a Song Position Pointer message, it will change the location of the song just as when you change the song location by operating the OASYS, and the KARMA function will be controlled in the same way as when you change the location on the OASYS.

In Program and Combination modes, Song Start, Continue, and Stop messages that the OASYS receives will control the KARMA function.

- While the KARMA function is running, Song Start, Continue, and Song Position Pointer messages received by the OASYS will reset the KARMA function, causing the generated phrases or patterns to start from the beginning.
- If a Song Stop message is received, the KARMA function will stop.

Master operation

Connect the OASYS' MIDI OUT to the MIDI IN of your external MIDI device.

Set **MIDI Clock** (Global 1–1a) to Internal. The connected external MIDI device will synchronize to the MIDI realtime clock and realtime commands it receives.

Note: The same applies if MIDI Clock=Auto and MIDI realtime clock messages are being transmitted. For more information, see "MIDI Clock (MIDI Clock Source)" on page 652 of the Parameter Guide.

Synchronization via MIDI clock

The connected external MIDI device will synchronize to the MIDI clock of the OASYS.

Synchronization via MIDI realtime commands

Enable Start/Stop Out in Prog/Combi

You can set up OASYS so that starting and stopping KARMA in Program and Combi modes will also control start and stop on external MIDI devices, such as sequencers and drum/groove machines (such as the KORG Electribe series).

To do so:

1. Go to the **Global MIDI** page.
 2. Under **MIDI Routing Setup**, turn on "Enable Start/Stop Out in Prog/Combi."
- In Program and Combination modes, playing a note-on from the keyboard or pads to trigger the GE selected for a KARMA module will also cause the MIDI system realtime message "Start" to be sent at the trigger timing.

- After the Start message has been sent, turning off KARMA ON/OFF will send the MIDI system realtime "Stop" command.

Appendices

Troubleshooting

If you experience problems, refer to the relevant item and take the appropriate measures.

Power supply

Power does not turn on

- Is the power cable connected to an outlet? For more information, see “Connections” on page 37.
- Is the POWER switch turned on?
- Turn on the rear panel POWER switch. See “Turning the power on/off” on page 40.

LCD screen

Display is blank or incorrect

The power is turned on, but nothing is shown in the LCD screen. However, the OASYS functions normally when you play the keyboard or perform other operations.

- Are the LCD screen’s color, contrast, and backlight brightness adjusted correctly?
1. Press the GLOBAL switch, and then press the EXIT switch twice.
 2. Hold down the ENTER switch, and press numeric key 6.
 3. Press the UTILITY RESET CONTROLS switch. The display will be reset to the standard settings.
 4. Press the EXIT switch.

The power is turned on, but the LCD screen does not display normally, or an error message is displayed. There is no sound when you play the keyboard, and the OASYS does not function normally.

It is possible that the system has been damaged. Use the included restore CD to restore the OASYS to its factory state.

Problems using the touch-screen

Can’t operate the LCD screen correctly

On the Basic Setup tab of the Global P0 page, use the **Touch Panel Calibration** page menu command to adjust the touch panel response.

Note: If you are unable to select commands from the page menu, do the following:

1. Press the GLOBAL switch.
2. Press the EXIT switch twice.
3. Hold down the ENTER switch and press 3 on the numeric keypad.

The Touch Panel Calibration page will appear. Follow the on-screen instructions to re-calibrate the touch panel.

Can’t switch modes or pages

If you’re doing any of the following, you may not be able to change modes or switch to a different page:

- Recording or playing back a song or pattern
- Sampling
- Playing a CD
- Playing a WAVE file

In Combination, or Sequencer modes, can’t edit the value of Timbre/Track parameters such as MIDI Channel or Status

Some parameters can’t be edited while notes are playing, either locally or from MIDI. If the damper pedal is held down, or if its calibration is incorrect, notes may be sustaining even if they aren’t audible.

- Are you using a damper pedal with a polarity that does not match the **Damper Polarity** setting (Global P2: Controller/Scale)? For more information, see “Damper Polarity,” on page 659 of the Parameter Guide.
- In some cases, this problem can be solved by executing the page menu command **Half Damper Calibration** (Global P0: Basic Setup). For more information, see “Half Damper Calibration,” on page 683 of the Parameter Guide.

No beep sounds when you touch the LCD screen

Check the **Beep Enable** check box (Global P0: Basic Setup). For more information, see “Sounding a beep when you press the LCD screen” on page 148.

Audio input and output

No sound

Are connections made correctly to your amp, mixer, or headphones? For more information, see “Connections” on page 37

Is the connected amp or mixer powered-on, and is its volume raised?

Is Local Control turned on?

- In Global P1: MIDI, check the **Local Control On** check box.

Is the VOLUME slider raised?  p.20

Is the MASTER slider raised? (See “Master Volume” on page 21 of the Parameter Guide.)

Could MASTER VOLUME have been assigned to the ASSIGNABLE PEDAL, and the pedal set in the minimum position?

Could the vector joystick be controlling the volume, and the volume lowered in this way?

If there is no sound from the AUDIO OUTPUT (INDIVIDUAL) 1–8 jacks, make sure that **Bus Select** or **Bus Sel.** (Bus Select) following the insert effect is set to 1–8, or 1/2–7/8.

If a specific timbre doesn’t sound in Combination mode, is its Play/Mute button set to Play?

Alternatively, are all Solo settings turned off? (If the Solo button is blinking, this means that at least one timbre is being soloed.)

If a specific track doesn’t sound in Sequencer mode, is its Play/Rec/Mute button set to Play? Alternatively, are all Solo settings turned off? (If the Solo button is blinking, this means that at least one track is being soloed.)

Make sure that the **Status** is INT or BTH. (See “Preparations for recording” on page 83.)

Are the Key Zone and Velocity Zone set so that sound will be produced when you play?

Can’t output the main L/R signal from the ADAT OUT jack of the EXB-DI option

In the Global P0: Basic Setup– Audio page, **L/R Bus Indiv. Assign** must be set to the desired EXB-DI ADAT OUT channels.

Can’t output sound from an audio CD

Make sure that you have selected the Disk mode Play Audio CD page or Sampling mode.

Is the output of the audio CD being input correctly?

- In the Disk mode Play Audio CD Page, make the appropriate settings for **Bus Select (IFX/Indiv.)** and **Level**. Alternatively, in the Sampling mode P5: Audio CD– Ripping page, make the appropriate settings for **Bus Select (IFX/Indiv.)** and **Level**.
- Is the **Drive Select** setting correct?

Is the **Volume** slider raised? (Disk mode Play Audio CD page, Sampling P5: Audio CD– Ripping page)

Has the CD been finalized?

- A CD-R/RW disc that you wrote using the Disk mode Make Audio CD page cannot be played in the Disk mode Play Audio CD page or in Sampling mode until you also finalize the disc. Execute the page menu command **Finalize Audio CD** to finalize the disc. For more information, see “Finalize Audio CD” on page 725 of the Parameter Guide.

Audio inputs don’t work properly

Are the appropriate sources connected to the AUDIO INPUT 1–4 jacks, or the S/P DIF IN jack?

If there is no sound in Sampling mode, check that **Bus Select (IFX/Indiv.)**, and **Level** are set correctly in the Sampling P0: Recording– Audio Input page. Alternatively, is SAMPLING REC turned on?

If there is no sound in Program, Combination, and Sequencer modes, check that **Bus Select (IFX/Indiv.)**, and **Level** are set correctly in Global P0: Basic Setup– Audio page; or in the P0: Sampling pages of Program, Combination, or Sequencer modes.

Is **Use Global Setting** set correctly?

- If you are inputting sound to the AUDIO INPUT 1 and 2 jacks, make sure that the AUDIO INPUT LEVEL knob is raised.

If you are inputting sound to the AUDIO INPUT 1 and 2 jacks, is the MIC/LINE and PHANTOM POWER switch set appropriately?

Is an unsupported format being input from the S/P DIF IN jack?

- Please connect an instrument or digital audio device that is compatible with CP-1201 or S/P DIF.

Is the correct sampling frequency being input from the S/P DIF IN jack?

- Sampling frequencies of 48 kHz and 96 kHz can be input. If you input an unsupported sampling frequency, noise will occur or a message of “CLOCK ERROR !” will be displayed.

Set **S/P DIF Sample Rate** to match the sampling frequency that is being input (either 48 kHz or 96 kHz). The default setting for **S/P DIF Sample Rate** is 48 kHz.

-  If **System Clock** is set to S/P DIF and **S/P DIF Sample Rate** is set to 48 kHz, and you want to change the sampling frequency that is being input to the S/P DIF IN jack from 96 kHz to 48 kHz or from 48 kHz to 96 kHz, you must make sure that the OASYS is not accessing data when you make the change. Also, do not touch the OASYS at this time. In particular, you must not change the sampling frequency being input to the S/P DIF IN jack when data access is occurring (e.g., load/save, read/write, or sampling operations involving the internal hard disk, floppy disk, CD-R/RW, external USB media, sample memory, or internal memory).

Digital audio input is sometimes not heard for two or three seconds.

- When you change the sampling frequency in **S/P DIF Sample Rate** (e.g., from 48 kHz to 96 kHz), two or three seconds will be required in order to lock to the new sampling frequency. Please wait until the sound is heard.

Noise, Distortion, and other audio problems

Noise and distortion occur in the input sound or the recorded sound

If you are recording from audio inputs 1 and/or 2, are the **AUDIO INPUT LEVEL** knob and **Recording Level** setting appropriate?

- If **Recording Level** indicates “ADC OVERLOAD !,” adjust the **LEVEL** knob. If “CLIP !” is displayed, adjust the **Recording Level** slider.

If you are inputting to the **AUDIO INPUT 3, 4** and **S/P DIF IN** jack, are the level of the output device and the **Recording Level** set appropriately?

- If “CLIP !” appears, adjust the **Recording Level** slider.

Is the system clock set correctly?

- If cyclic click noise is occurring, check that you have selected the **System Clock** that is being input.

Noise or oscillation is heard

When using an effect on the external audio source being input from **AUDIO INPUT 1** and **2**, oscillation may occur depending on the type of effect or on the parameter settings. Please adjust the input level, output level, and effect parameters. You need to be particularly careful when using a high-gain effect.

After a sample edit has been executed, or after a stereo sample has been recorded, a small noise may be heard. This has no effect on the audio data that was edited or sampled.

When using the **MIDI/Tempo Sync** function to control the delay time of an effect, noise may occur in the delay sound. This noise is due to discontinuities in the delay sound, and is not a malfunction.

Some effects, such as **023: Stereo Analog Record**, generate noise intentionally. It is also possible to create oscillation using a filter with resonance. These are not malfunctions.

Notes do not stop

In **Program P1: Basic/Vector**, select the **Program Basic** page, make sure that the **Hold** check box is unchecked.

Could you have used **Tone Adjust** to turn **Hold** on?

In **Global P2: Controller/Scale**, make sure that **Damper Polarity** or **Foot Switch Polarity** is set correctly.

Programs and Combinations

Program or Combination does not play correctly

Bank INT-E preloaded programs don't play correctly.

Are the **EXs1 ROM Expansion** multisamples loaded?

- In **Global mode**, use the **Expansion Sample Setup** menu command to load the **EXs1 ROM Expansion**. Note that since you can't use the **EXs1 ROM Expansion** and **EXs2 Concert Grand Piano** at the same time, the **EXs2 Concert Grand Piano** will be unavailable while you're using the **EXs1 ROM Expansion**.

For more information, see “**Expansion Sample Setup**” on page 684 of the **Parameter Guide**.

Bank USER-A preloaded programs don't play correctly.

Are the **EXs2 Concert Grand Piano** multisamples loaded?

- In **Global mode**, use the **Expansion Sample Setup** menu command to load the **EXs2 Concert Grand Piano**. However since you can't use the **EXs1 ROM Expansion** and **EXs2 Concert Grand Piano** at the same time, the **EXs1 ROM Expansion** will be unavailable while you're using the **EXs2 Concert Grand Piano**.

Settings for oscillator 2 are not displayed

Make sure that the **Oscillator Mode** (**Program P1: Basic/Vector**) parameter is set to **Double**.

EXi2 related settings are not displayed

On the **Basic/Vector** page, is there an **EXi** instrument selected for **EXi2**? For more information, see “**EXi 2 Instrument Type**” on page 158 of the **Parameter Guide**.

EXi programs don't play correctly in a Combination.

Does the **Timbre's** number have a gray background color, instead of blue? And, does **[Inactive]** appear after the **Program name** in the **Selected Timbre Info**?

- The **Programs** in the **Combination** are asking for more than the maximum available **EXi** fixed resources. Remove one or more of the **EXi Programs** which uses fixed resources.

For more information, see “**CX-3 & STR-1: Limitations on EXi fixed resources**” on page 326 of the **Parameter Guide**.

A combination does not play correctly after you load data

In the dialog box when you saved the data, did you check the items that you wanted to save?

Are the bank/numbers of the programs used by the combination the same as when the combination was created?

- If you have switched program banks, you can use the **Change all bank references** menu command to change the program bank for each timbre of a combination. For more information, see “Change all bank references” on page 682 of the Parameter Guide.

Songs

Song does not play correctly after being loaded

In the dialog box when you saved the data, did you check all of the items that you wanted to save?

Are the programs used by the song the same as when the song was created?

- If you have switched program banks, you can use the page menu command **Change all bank references** to change the program bank for each track of a song. For more information, see “Change all bank references” on page 682 of the Parameter Guide.
- When saving the song, it is best to use **Save All** or **Save PCG & SEQ** so that the programs are saved together with the song. Then when loading, load both the .PCG and the .SEQ data.

Have you loaded the multisamples and samples used by the program?

Audio tracks don't play

The audio files for the Song must be stored within a directory at the same directory level as the .SNG file, and that directory must be named with the first six characters of the .SNG file name, followed by “_A.” For instance, if the .SNG file is named WAMAZART.SNG, its audio folder must be named WAMOZA_A. If you move or rename the .SNG file, make sure to move or rename the main audio folder as well.

If the folder containing the WAVE files for the song you loaded has the wrong name, the icon is shown in gray. Could you have moved or renamed the folder?

Playback does not start when you press the SEQUENCER START/STOP switch in Sequencer mode

Is the **MIDI Clock** (Global P1: MIDI) set to Internal or Auto?

Can't record in Sequencer mode

Did you use **Track Select** to select the MIDI track or audio track that you want to record?

Can't write a Program

You can't write HD-1 programs into bank INT-F. Conversely, you can't write EXi programs into banks USER-A–E. However for banks USER-A–G, you can use the Global mode page menu command **Set Program User-Bank Type** to change the type of each bank, so that it will accommodate the desired type of programs. With the factory settings, bank USER-F is for EXi programs, and the remaining banks are for HD-1 programs. For more information, see “Set Program User-Bank Type” on page 682 of the Parameter Guide.

Is the Memory Protect **Song** check box (Global P0) unchecked?

Is the **MIDI Clock** (Global P1: MIDI) set to Internal or Auto?

EXi programs don't play correctly in a Song.

Does the Track's number have a gray background color, instead of blue? And, does [Inactive] appear after the Program name in the Selected Track Info?

- The Programs in the Song are asking for more than the maximum available EXi fixed resources. Remove one or more of the EXi Programs which uses fixed resources.

For more information, see “CX-3 & STR-1: Limitations on EXi fixed resources” on page 326 of the Parameter Guide.

A combination copied using “Copy From Combi” doesn't record via KARMA as it did when you were playing it in Combination mode

Is **Multi REC** (Sequencer P0: Play/REC) checked?

Are the settings in the Copy From Combination dialog box correct?

- In the Copy From Combination dialog box, check the **Multi REC standby** option before you execute the copy. This will cause the settings to be adjusted automatically.

Can't record your performance using Tone Adjust

Changes you make using Tone Adjust are recorded as system exclusive data. Did you check the Global mode MIDI Filter **Enable Exclusive** check box?

RPPR does not start

Is the Sequencer P0: Play/REC **RPPR** setting checked? (See “Using RPPR (Realtime Pattern Play/Record)” on page 112.)

Are **Assign**, **Pattern Select**, and **Track** set correctly? See “Using RPPR (Realtime Pattern Play/Record)” on page 112.

If the **MIDI Clock** (Global P1: MIDI) parameter set to Internal or Auto? See “MIDI Clock (MIDI Clock Source)” on page 652 of the Parameter Guide.

Can't record on an audio track

Have you unchecked the Memory Protect **Internal HDD Save** check box (Global P0)?

Have you set **Track Select** to the audio track you want to record?

If you want to perform multi-track recording (**Multi REC** checked), is **Play/Rec/Mute** set to REC?

Are the audio input settings correct?

- Please see Audio input and output, and Audio inputs don't work properly.

Is there space remaining on the hard disk?

- Delete unwanted WAVE files.

- Save a copy of important WAVE files on external media, and then delete them from the hard disk.

Are the **REC Source** settings correct?

A “File already exists” message appears, and you can't record.

- In the P0: Play/REC– Preference page, change the name of the WAVE file that you're going to record.
- Delete the files in the TEMP folder.

Can't import WAVE files into a region of an audio track

In the Import Region/WAVE dialog box, you selected a WAVE file but can't press the OK button.

- Only 48 kHz monaural WAVE files can be imported.
- You can only directly import WAVE files from the internal hard drive. To use files from CDs or external USB devices, you must first copy them to the internal hard drive, and then import the copied file into the Song.

Sampling

Can't sample

Are the audio input settings correct?

- Refer to “Audio input and output – Audio inputs don't work properly” p.216

Is there enough free RAM memory for sampling?

Is there free space in memory? For more information, see “0–1f: Free Sample Memory/Locations” on page 572 of the Parameter Guide, and “0–9: Media Information” on page 697 of the Parameter Guide.

- In order to sample to RAM memory, you must allocate sufficient space for sampling.
- If you are sampling to hard disk, select a different hard disk. For more information, see “Select Directory” on page 140 of the Parameter Guide
- Delete unneeded samples. For more information, see “Delete Sample” on page 615 of the Parameter Guide.
- Save important samples on external media, and then delete them from memory.

If you're sampling to the internal hard disk, did you uncheck the Memory Protect “Internal HDD Save” dialog box? (Global P0)

If you're sampling to external USB storage media, did you select recordable media?

Is the **Trigger** setting correct? For more information, see “Trigger” on page 16 of the Parameter Guide.

In Sampling mode if you are resampling with **Resample** set to Auto, has the sample to be resampled been assigned to the keyboard, and selected for **Key**? “Applying an insert effect to a sample and resampling the result” on page 131.

Is the **Source Bus** setting correct?

If a “buffer overrun error occurred” message is displayed frequently when you are sampling to hard disk, execute the page menu command **Check Medium** (Disk– Utility page) to find and correct any errors on the selected MS-DOS format media. For more information, see “Check Medium” on page 724 of the Parameter Guide

A stereo sample can't be played in stereo

Is the multisample actually stereo?

- Execute the page menu command “MS Mono To Stereo” to convert the multisample to stereo. For more information, see “MS Mono To Stereo/MS Stereo To Mono (Change Multisample Type)” on page 619 of the Parameter Guide

Is the sample name assigned correctly? (See “Stereo” on page 569 of the Parameter Guide.)

Volume of a recorded sample is too low/too high

Samples that you resampled at a **Recording Level** of approximately 0.0 (dB) have a lower volume than when you resampled them.

- Did you turn on the **Auto +12 dB On** setting when you resampled? See “Recording Level and Auto +12 dB On” on page 125.
- If you resampled with **Auto +12 dB On** turned off, turn on **+12 dB** (Sampling mode Loop Edit page) for that sample.

Song or CD playback stops temporarily when you sample

Is “Auto Optimize RAM” checked?

- If this is checked, RAM will be optimized automatically when sampling ends, meaning that the sound will stop when sampling ends. If a song is being played in Sequencer mode or if a CD is being played back, the playback will stop.

There is a time lag between pressing the SAMPLING REC switch and entering sampling-standby mode

The length of time until you enter sampling-standby mode will depend on the state of the free space on the hard disk (i.e., whether the free space is continuous or fragmented).

- When sampling to the hard disk, pressing the SAMPLING REC switch will cause the amount of space specified by **Sample Time** to be allocated within the hard disk.
- You should set **Sample Time** slightly longer than the length that you will actually sample, and avoid specifying an excessively long sample time.

KARMA

KARMA does not start

Is the KARMA ON/OFF switch turned on (lit)?

If a KARMA module does not start in Combination or Sequencer mode, is the **Run Check Box** checked for that module? Also, are the **Input Channel** and **Output Channel** settings appropriate?

Is **MIDI Clock** (Global P1: MIDI) set to Internal or Auto?

In the Global P0: Basic Setup page, could **All KARMA Off** be checked?

Vector

Can't control the volume

Is the **Enable Volume Control** check box checked?

Is the Combination or Sequencer mode **VJS Assign** setting appropriate?

Have you checked the **Enable Program Vector Volume** check box so that the volume control of a program can be reproduced in Combination or Sequencer mode?

In Combination or Sequencer mode, are the **Enable Combi Vector CC** or **Enable Song Vector CC** check boxes checked?

Have you checked the **Enable Program Vector CC** check box so that the CC control of a program can be reproduced in Combination or Sequencer mode?

CC control does not work

Is the **Enable CC Control** check box checked?

Are the **VJS X mode** and **VJS Y mode** settings appropriate?

An envelope doesn't operate according to its settings

Is the front panel vector joystick set to the center position? The operation of the envelope is offset by the position of the vector joystick.

- Hold down the RESET CONTROLS switch and move the vector joystick to reset it to the center.

Drum Kits

The drum sample's pitch does not change

You have left the **Assign** check box unchecked, and want to play the drum sample at the adjacent right a semitone lower, but the pitch does not change.

- If you have selected a drum program in Program mode, and then want to edit the drum kit in Global mode, go to the Program P2: Edit-Pitch, OSC1 Pitch Mod. page and set **Pitch Slope** to +1.0 before you enter Global mode.

Wave Sequences

The wave sequence does not advance

Is the **Run** check box checked?

Swing does not work properly

Is the wave sequence's **Mode** set to Tempo?

Is the wave sequence's **Swing Resolution** set appropriately?

Effects

Effects are not applied

Have you selected effect program 000?

- Select an effect other than 000: No Effect for “IFX1–12,” “MFX 1, 2” or “TFX 1, 2.”

Are the Effect Global SW **IFX 1–12 Off**, **MFX1&2 Off**, or **TFX1&2 Off** (Global P0: Basic Setup page) settings checked?

If you are in Combination, and Sequencer mode, and master effects are not applied when you raise the **Send1** or **Send2** of the timbre/track, does **Return 1** or **Return 2** from the master effect need to be raised?

Alternatively, has **Send 1** or **Send 2** for each oscillator of the program used by the timbre/track been lowered?

Note: The actual send level is determined by multiplying the send setting of each oscillator in the program with the send setting of the timbre/track.

Have you routed the output to an insert effect?

MIDI

The OASYS does not respond to incoming MIDI data

Are all MIDI cables connected correctly?

Is the MIDI data being received on the channel on which it is being transmitted?

The OASYS does not respond correctly to incoming MIDI data

Are the Global P1: MIDI settings **MIDI Filter Enable**, **Program Change**, **Enable Bank Change**, **Enable Control Change**, **Enable AfterTouch**, and **Enable Exclusive** each checked?

Does the OASYS support the types of messages that are being sent to it?

Incorrect response to program change messages

Is the **Bank Map** setting correct?

Disks, CDs, and USB Media

Internal hard drive, external USB devices

External USB devices are not recognized

Has the drive been formatted?

Is the external device connected correctly?

You may have turned on the power of the USB device after powering-on the OASYS.

- Execute the page menu command **Scan device** (Disk– Media Information) to re-mount the USB device. For more information, see “Scan device” on page 724 of the Parameter Guide.

“Error in writing to medium” occurs frequently when saving data to the internal hard drive or external device

Execute the page menu command **Check Medium** (Disk– Utility page) to detect and repair errors on the media. For more information, see “Check Medium” on page 724 of the Parameter Guide.

CD-R/RW

CD-R/RW drive is not recognized, or Can't write

Was the drive subjected to physical shock or vibration while data is being written?

If you are unable to save data such as PCG or SNG files, has the disc been formatted?

If you are writing audio tracks to create an audio CD, it is not necessary to format the disc.

Are you using the recommended media for your drive?

If you are writing from an external USB drive to CD-R/RW, it is possible that the transfer speed is insufficient.

- Writing may be successful if you lower the writing speed.
- Writing may be successful if you first copy the data from the external USB drive to the internal hard disk, and then execute the writing operation from the internal hard disk.

Are you using blank media?

- If using CD-R, please use new media. If using CD-RW, use the page menu command **Erase CD-RW** (Disk– Make Audio CD) to erase the contents of the media before you execute Save.

An OASYS CD-R/RW is not recognized by an external device

A CD-R/RW saved or copied on the OASYS using packet writing is not recognized on a computer.

- If you install a UDF version 1.5 compatible UDF reader or packet writing software on your computer, it will be possible to recognize the disc.
- In the case of a CD-R, it may be possible to make the disc be recognized by executing the page menu command **Convert to ISO9660 Format** (Disk–Utility page) to convert the disc to ISO9660 format. However depending on the state in which the disc was saved, it may be converted into ISO9660 level 3 format, and may still not be recognized. In this case if you install ISO9660 level 3 compatible reader software or packet writing software on your computer, it will be possible to recognize the disc.

A CD-R/RW that was saved or copied on the OASYS using packet writing is not recognized by the TRITON/TRITON pro/TRITON proX/ TRITON-Rack/TRITON Le.

- These models do not support UDF version 1.5, and therefore will not recognize such a disc.
- In the case of a CD-R, it may be possible to make the disc be recognized by executing the page menu command **Convert to ISO9660 Format** (Disk–Utility page) to convert the disc to ISO9660 format. However depending on the state in which the disc was saved, it may be converted into ISO9660 level 3 format, and may still not be recognized.

Can't write audio tracks

Additional writing is not possible on a CD-R/RW disc that has been finalized.

Can't play back the disc on an audio CD player

Did you finalize the disc?

- If you want to finalize the disc after writing additional data, check the **Execute finalize too** check box when executing the page menu command "Write to CD" (Disk– Make Audio CD),

so that the disc will be finalized. For more information, see "Write to CD" on page 725 of the Parameter Guide.

- If you only want to finalize the disc, select the page menu command **Finalize Audio CD** (Disk– Make Audio CD), and press the OK button to finalize the disc. For more information, see "Finalize Audio CD" on page 725 of the Parameter Guide.

Are you using CD-R media?

- Since some CD players are unable to play CD-RW media, we recommend that you use CD-R media.

Have you tried using a different type of media?

- Some CD-R/RW media cannot be played by some CD players. You may be able to play back successfully by using a different type (brand) of CD-R/RW media.

WAVE files

Can't load

Is the WAVE file in a format that the OASYS can load?

- Only 48 kHz or 44.1 kHz WAVE files can be inserted into the Track CD List in the Disk mode Make Audio CD page.
- In Sequencer mode, only monaural 48 kHz WAVE files can be inserted into an audio track.

Can't preview

Is the WAVE file in a format that the OASYS can load?

- Only 48 kHz WAVE file data can be previewed by pressing the Play button in the directory window.
- You can't preview if the name of the WAVE file on external media is longer than eight characters. Copy the file to the internal hard disk before you preview it.

Other problems

Fan operating noise increases or changes

This is not a malfunction. The OASYS' cooling system fan is controlled by a temperature sensor and a program. The speed of the fan will change according to the surrounding temperatures and the operational state.

Power turns off automatically

The openings on the left and right sides are cooling vents. Be sure to place the unit so that the sides are at least 10 cm from a wall or similar object that might block them, and do not place any obstructing object near the cooling vents. If the OASYS is not cooled adequately, the internal temperature will rise. The power supply may shut down automatically to protect the device from high temperatures.

Date and time are incorrect

Saved files or sampled WAVE files have an incorrect date or time.

- Use the page menu command **Set Date/Time** (Disk– Utility page) to set the current date and time. For more information, see "Set Date/Time" on page 723 of the Parameter Guide.

Pads don't respond correctly

Execute the page menu command **Pad Calibration** (Global P0: Basic Setup) to adjust the pad sensitivity correctly. For more information, see "Pad Calibration" on page 683 of the Parameter Guide.

Media that can be used with the OASYS

Types of media supported by the OASYS

(as of April 2005)

Internal hard disk

Naturally, you can read and write data using the built-in hard disk.

External USB storage media

The OASYS supports USB external storage class devices, including hard drives, flash drives, magneto-optical disks, floppy disks, etc. Both MS-DOS FAT16 and FAT32 formats are supported, with the following capacities:

FAT32: up to 2 Terabytes (2,000 Gigabytes)

FAT16: up to 4 Gigabytes

For more information, including requirements for external USB storage media and details on connecting USB devices, please see “6. Connecting USB devices” on page 39.

CD-R/RW (Internal and USB)

The OASYS can read and write UDF format CD-R/RW disks. For more information, see “CD-R/RW disks on the OASYS: UDF and packet-writing” on page 1033 of the Parameter Guide.

The OASYS can also play and record audio CDs (CD-DA), and read ISO9660 (level 1) CDs.

Operations that the OASYS can perform on media

Functions available with all media

- Saving and Loading files (Disk mode)
You can save and load any data stored in memory. For details on OASYS file types, please see “Files, directories, and icons” on page 691 of the Parameter Guide. Loading or saving divided files is supported for USB media.
- Utility operations (Disk mode)
You can copy or format media.
- Sampling/resampling (Program, Combination, Sequencer, Sampling modes)
If **Save to** = DISK, sampled/resampled Wave files will be written directly to media.
- Wave file playback (Sequencer, Disk modes)
Some limitations apply.*²

- Audio CD creation (Disk mode)
You can create audio CDs from WAVE files, using either internal or USB CD-R/RW drives.
- Convert to ISO9660 Format (Disk mode)
The native OASYS CD-R/RW format is UDF, which allows you to write repeatedly to the same CD. UDF is a standard format, but you can also convert such disks to the more common (but less flexible) ISO9660 format.

Functions available only on the internal hard disk

- Hard disk recording (Sequencer mode)
You can record and play back audio tracks.
- Audio track editing (Sequencer mode)
You can edit the WAVE files used by audio tracks.

Function	Internal HD	USB HD, Flash Drives, MO	USB Floppy Disks	Internal & USB CD-R/RW (UDF Packet Write)	Internal & USB CD-R/RW (ISO9660)
Save	●	●	●	●	×
Load	●	●	●	●	●
Sampling/Resampling	●	●	×	_ *1	_ *1
WAVE File Play	●	▲ *2	×	×	×
Make Audio CD	● (source)	● (source)	×	●	● (source)
Convert to ISO9660 Format	–	–	–	●	–
Audio Track Recording	●	×	×	×	×
Audio Track Edit	●	×	×	×	×

● : supported

× : not supported

– : not applicable

▲ : partially supported—see the specified note

¹: CD-DA (audio CDs) can be ripped in Sampling mode.

²: WAVE files on external USB media can only be previewed from disk if the file name is eight characters or less. This restriction applies only to external media, and not to the internal hard drive.

Note: If you have any questions regarding the media that can be used, please contact your local Korg distributor. You may also check the Korg website (<http://www.korg.com>).

Specifications and options

Operating temperature	+5 – +35 °C		
System	OA (Open Architecture) Synthesis System		
Keyboard	OASYS 88	88 key Real Weighted Hammer Action (RH2) * The key weight of the RH2 keyboard differs in four stages across the pitch range (with low notes being heavier, and high notes being lighter), delivering a playing feel similar to that of a grand piano.	
	OASYS 76	76 key synth-action keyboard	
Sound Engine	Synthesis Types	HD-1 (High Definition Synthesizer)	
		EXi (Expansion Instruments)	AL-1 (AL-1 Analog Synthesizer)
			CX-3 (CX-3 Tonewheel Organ)
			STR-1 (STR-1 Plucked String)
			MS-20EX (CMT Modeled Analog Synthesizer)
	PolysixEX (CMT Modeled Analog Synthesizer)		
	Maximum Polyphony	Maximum polyphony varies depending on the synthesis type, as shown below. The actual polyphony will vary depending on the synthesis types and effects being used.	
		HD-1	172 voices max, without effects.
		AL-1	96 voices max, without effects.
		CX-3	172 voices max, without effects.
		STR-1	48 voices max, without effects.
		MS-20EX	48 voices max, without effects.
		PolysixEX	172 voices max, without effects.
	Dynamic voice allocation between synthesis types: exclusive system intelligently allocates resources as necessary, so that the user does not need to specify fixed numbers of voices for each type.		
	Preset PCM	314MB (1,505 Multi Samples and 1,388 Drum Samples).	
Bundled EXs PCM Libraries	313MB: ROM Expansion EXs1 (229 Multi Samples and 1,483 Drum Samples). 503MB: Concert Grand EXs2 (10 Multi Samples).		
PCM RAM	500MB * The amount of PCM RAM will change depending on how you use the included EXs, system software, and options.		
Wave Sequences	User Memory	374 Wave Sequences	
	Preload	150 Wave Sequences	
	New Wave Sequence features include support for stereo multisamples, enhanced tempo synchronization, real-time modulation, dual AMS outputs per step, crossfade shapes, and more.		
HD-1 Programs	Advanced Vector Synthesis	Control oscillator volumes and synthesis & effects parameters via the Vector Joystick and the tempo-synchronized Vector Envelope.	
	Single/Double Structure	Single = OSC1 only; Double = OSC1 & OSC2. Double mode lets you layer two completely separate synth voices, each with their own velocity-switched oscillator, dual filters, EGs, LFOs, etc.	
	Oscillator	4 velocity zones per oscillator, with switching, crossfades and layers.	
		Each zone can play mono or stereo Multisamples or Wave Sequences.	
	Filters	Dual resonant filters per voice.	
		Single, Serial, Parallel, and 24dB(4-Pole) configurations.	
		Low Pass, High Pass, Band Pass, and Band Reject modes.	
	Driver	Per-voice nonlinear driver and low boost.	
EQ	Three bands, with sweepable mid.		
Modulation	3 Envelopes, 2 per-voice LFOs, Common LFO, 4 Key Tracking generators.		
	AMS - modulate a large number of synthesis parameters via LFOs, Envelopes, and real-time controllers.		
	2 AMS Mixers - combine and process AMS sources. Add, multiply, smooth, quantize, and more.		
EXi Programs	Advanced Vector Synthesis	Control oscillator volumes and synthesis & effects parameters via the Vector Joystick and the tempo-synchronized Vector Envelope.	
	Modulation	Common Step Sequencer: 32-step sequencer with smoothing, adjustable step duration, and tempo synchronization.	
		AMS - modulate a large number of synthesis parameters via LFOs, Envelopes, and real-time controllers.	
		Common LFO, 2 Key Tracking Generators.	
EQ	Three bands, with sweepable mid.		

AL-1	Oscillators	Ultra-low-aliasing oscillators, using a new design. OSC1, OSC2, Sub OSC, Noise Generator, Ring Mod, modulatable oscillator mix.		
	Audio input	Run real-time audio through the synthesis engine, including ring mod, filters, drive circuit, amp, and EQ.		
	Filters	Dual multi-mode filters per voice. Single, Serial, Parallel (with split stereo output), and 24dB(4-Pole) configurations. Low Pass, High Pass, Band Pass, and Band Reject modes.		
		Multi Filter mode (Filter A only)	Modulatable mix of Low Pass, High Pass, Band Pass, and dry input, for creating a wide variety of unique filter types and effects.	
	Driver	Per-voice nonlinear driver and low boost.		
	Modulation	5 Envelopes, 4 per-voice LFOs, 2 Key Tracking generators, 2 AMS Mixers Per-voice Step Sequencer: 32-step sequencer with smoothing, adjustable step duration, and tempo synchronization.		
CX-3	Tone Wheel Organ Model	A further evolution of Korg's acclaimed CX-3. Phase-synchronous tonewheels (clean and vintage modes), percussion, key click, wheel brake		
	EX Mode	Four additional, user-specified drawbars, and expanded percussion.		
	Built-in effects	Rotary Speaker, Vibrato/Chorus, Amp with overdrive, 3 Band EQ (Treble, Mid, Bass)		
	Drawbar Control	9 front-panel sliders (using Tone Adjust).		
	Split	Full control of upper and lower drawbars, even in EX mode.		
	Modulation	2 AMS Mixers		
	STR-1	Physically modeled string	Includes physically modeled damping, decay, dispersion, nonlinearity, harmonics, dual pickups, and more. Almost all string parameters may be modulated in real-time, for unsurpassed creative and expressive control.	
String excitation		Three independent excitation sources can be used simultaneously: Pluck, Noise, and PCM. 16 preset "pluck" types, with modulatable width and randomization. Noise generator with saturation and dedicated lowpass filter.		
		PCM Oscillator	Korg's ultra-low-aliasing technology, as introduced in the HD-1. 4 velocity zones per oscillator. Uses any mono ROM, EXs, or RAM multisamples. PCM can either be used as an excitation signal, or layered with the output of the string.	
		Excitation filter	Dedicated 2-pole multimode filter for shaping the string excitation. Filter can be enabled/disabled separately for each excitation source. Low Pass, High Pass, Band Pass, and Band Reject modes.	
Audio input and feedback		Run real-time audio through the string, including feedback through effects. Modeled feedback includes modulatable instrument-to-amp distance and orientation.		
Filters		Dual multi-mode filters per voice. Single, Serial, Parallel (with split stereo output), and 24dB(4-Pole) configurations. Low Pass, High Pass, Band Pass, and Band Reject modes.		
		Multi Filter mode (Filter A only)	Modulatable mix of Low Pass, High Pass, Band Pass, and dry input, for creating a wide variety of unique filter types and effects.	
Modulation		5 Envelopes, 4 per-voice LFOs, 2 Key Tracking generators, String Tracking generator, 4 AMS Mixers.		
MS-20EX (Optional)		CMT Modeling	Uses Korg's CMT modeling, reproducing not only the sound but also the character and response curve of each parameter in a way that is completely faithful to the original model.	
	Oscillators	Ultra-low-aliasing oscillators. VCO1, VCO2, Ring Mod, Pink and White Noise Generator.		
	Audio input	Run real-time audio through the synthesis engine and External Signal Processor.		
	Filters	12dB/octave High Pass and Low Pass self-resonant filters. ESP section: 24dB/octave Low Cut and High Cut filters, available per voice.		
	Patch Panel	Patchable audio and modulation, at audio rates.		
		New features, compared to the original MS-20	New patch points: VCO 1 & 2 outputs, HPF input, LPF input and output, VCA input, EXi Audio Input, BPF input, Mixers 1 & 2 inputs and outputs. Dual 2-in, 1-out mixers for scaling and merging audio and/or modulation signals, including phase inversion. Patch "mults:" connect one output to many inputs.	
ESP (External Signal Processor)	Use incoming audio as a trigger and/or CV source.			
Modulation	Original DAR and HADSR EGs 1 & 2, original MG (updated with MIDI sync), Sample-and-Hold, MVCA 4 additional multi-stage Envelopes, 4 additional per-voice LFOs, and 4 AMS Mixers.			

PolysixEX (Optional)	CMT Modeling	Uses Korg's CMT modeling, reproducing not only the sound but also the character and response curve of each parameter in a way that is completely faithful to the original model.
	Oscillators	VCO: Saw, Pulse, PWM Sub Oscillator: Off, 1 octave below, 2 octaves below
	Filter	24dB/octave Low Pass self-resonant filter.
	Effects	Integrated Polysix Chorus, Phase, and Ensemble.
	Arpeggiator	Integrated MIDI-synced arpeggiator, with adjustable Range, Mode, and Latch
	Modulation	Original ADSR EG and MG (updated with MIDI sync). 2 additional multi-stage Envelopes, 2 additional per-voice LFOs, and 4 AMS Mixers.
Combinations	16 Timbres	Keyboard and velocity splits, layers, and crossfades of up to 16 Programs and/or external MIDI devices
	Master Keyboard functionality	
	Advanced Vector Synthesis	Control Timbre volumes and synthesis & effects parameters via the Vector Joystick and the tempo-synchronized Vector Envelope.
Drum Kits	Stereo and mono drum samples. 4-way velocity switches with crossfades and adjustable crossfade shapes (Linear, Power, Layer).	
The number of ... -Combinations -Programs -Drum Kits	User Combinations	1,792 Combinations/384 Preload
	User Programs	1,664 Programs/1160 (640 PCM + 512 EXi 1+8 EXs 2) Preload
	User Drum Kits	152 Drum Kits/40 Preload
	General MIDI 2 Programs	256 GM2 Programs
	General MIDI 2 Drum Programs	9 GM2 Drum Programs
Sampling	Open Sampling System (Resampling, In-Track Sampling)	
	16bit/48kHz: Stereo/Mono Sampling	
	Sampling time	RAM: Maximum sampling time depends on the amount of RAM memory (see "PCM RAM"). In the case of 500 MB, approximately 93 minutes of monaural or 46 minutes 30 seconds of stereo sampling is possible. DISK: Maximum sampling time to the internal hard disk is approximately 80 minutes per sample file, for either mono or stereo. This will use approximately 440 MB for monaural or 879 MB for stereo.
	Number of samples/multisamples	4,000 Samples/1,000 Multisamples (Max. 128 indexes per Multisample.)
	Sample directly from audio CDs (CD-DA)	
	Load AKAI S1000/3000, KORG Format, AIFF, and WAVE sample data Time Stretch, Time Slice, Crossfade Loop, and other standard editing features.	
Effects	12 Insert Effects	In-line processing; stereo in - stereo out.
	2 Master Effects	Two effects sends; stereo in - stereo out.
	2 Total Effects	For overall processing on the main outputs, such as compression, limiting, and EQ; stereo in - stereo out.
	3-band Track EQ	High, low, and sweepable mid band. Per Program in Program Mode, per Timbre in Combination mode (16 total), and per Track in Sequencer mode (32 total).
	185 different Effects types	Any Effect type may be used for Insert, Master, or Total Effects.
	Dynamic Modulation	Real-time control of effects parameters.
	Common LFO	Synchronized LFO modulation of multiple effects.
	Effects Control Bus	Stereo side-chaining for compressors, gates, vocoders, etc.
	Effects Presets	Up to 32 per Effect
KARMA	KARMA Modules	1 Module in Program Mode; 4 Modules in Combination and Sequencer Modes, plus Master control module
	GE	2,048 Presets New RTC Models provide more consistent control of KARMA parameters.
	Controllers	ON/OFF, LATCH, CHORD ASSIGN, MODULE CONTROL
		On the Control Surface: KARMA REALTIME CONTROL SLIDERS 1-8, KARMA SCENE buttons 1-8, KARMA SWITCHES 1-8 Independent, programmable realtime control settings for each Module
KARMA Wave Sequence Control (change Multisamples via the KARMA engine), GE Sub-Categories, Free Randomize function, Time Signature Control, Tempo synchronization, Auto RTC (Real Time Control) setup.		
Sequencer/HDR	16MIDI Tracks, 16 Audio Tracks & 1 Master Track	
	200 Songs	
	Resolution: 192 ppq (parts per quarter-note)	
	Tempo: 40.00-240.00 bpm (1/100 bpm resolution)	
	Up to 400,000 MIDI events (with MIDI data only) or 300,000 Audio events (with Audio data only)	
	MIDI tracks	16 Tracks + 1 Master Track 156 Presets /100 User Patterns (per Song), 18 Preset and 16 User Template Songs Sequencer Format: KORG (OASYS) & SMF (formats 0 and 1)
	HDR Audio tracks	16-track playback, 4-track simultaneous recording; WAV file format Maximum single-file recording time (mono): 80 minutes. Automation: Volume, Pan, EQ, and Send 1/2 Up to 10,000 Regions, Event Anchor, BPM Adjust
	Other Functions	RPPR (Realtime Pattern Play/Recording): 1 set per Song.

Load/Save/Disk Utility/Audio CD	Load, Save, Utility, Make Audio CD, Play Audio CD			
	Data Filer functionality (Save and Load MIDI System Exclusive Data)			
	CD-R/RW (UDF Format read/write), Record & Play audio CDs (CD-DA), ISO9660 Level 1			
Controllers	Joystick, Vector Joystick, Ribbon Controller, SW1/SW2.			
	Pads 1-8	Velocity-sensitive drum pads and chord triggers.		
		PAD MODE switch - selects velocity-sensitive or fixed-velocity operation		
	Control Surface	CONTROL ASSIGN Switches	TIMBRE/TRACK, AUDIO, EXTERNAL, R. TIME KNOBS/KARMA, TONE ADJUST	
		MIXER KNOBS Switch	Switches knobs between CHANNEL STRIP & INDIVIDUAL PAN	
		Controllers:	Functions (depending on CONTROL ASSIGN setting):	
		8 Knobs (with LED value indicators)	Channel Strip, Individual Pan, External MIDI, Realtime modulation, Tone Adjust	
		8 Switches (top row)	Play/Mute, External MIDI, KARMA Scenes, Tone Adjust	
		8 Switches (bottom row)	Select/Solo, External MIDI, KARMA Switches, Tone Adjust	
		8 Sliders (with LED value indicators)	Volume, External MIDI, KARMA Control, Tone Adjust	
		1 Master Slider (with LED value indicators)	Volume, External MIDI, Tone Adjust	
	KARMA Controller Section	Switches = ON/OFF, LATCH, CHORD ASSIGN, MODULE CONTROL		
User Interface	Display	10.4 inch Touch View Color Graphical Interface, with adjustable Display angle. Color LCD: 640 x 480 pixel TFT Display, software-controlled LCD Contrast.		
	MODE	Switches = COMBI, PROGRAM, SEQ, SAMPLING, GLOBAL, DISK		
	Value Controllers	Switches = Inc/Dec, 10-key numeric keypad, -, ENTER, VALUE Slider, VALUE Dial		
	UTILITY	Switches = HELP, RESET CONTROLS, COMPARE, FUNCTION		
	BANK	Switches = INT-A...INT-G, USER-A...USER-G		
	SEQUENCER	Switches = PAUSE, REW, FF, LOCATE, REC/WRITE, START/STOP		
	SAMPLING	Switches = REC, START/STOP		
	TEMPO	Switches = TAP TEMPO, TEMPO Knob		
Other	Switches = EXIT, VOLUME Slider			
Common specifications	Frequency response	20 Hz-20 kHz ± 1.0 dB	10 k Ω load	
	THD+N	20 Hz-20 kHz 0.01 %	10 k Ω load (typical)	

Audio Outputs			
Analog	Main outputs: L/Mono, R Individual outputs: 1–8	1/4" TS (Mono), unbalanced, Master Volume slider controls only L/Mono and R	
		Output Impedance	1.1k Ω stereo; 550 Ω mono (L/Mono only)
		Nominal Level	+4.0 dBu
		Maximum Level	+16.0 dBu
		Load Impedance	10 k Ω or greater
	Headphone output	1/4" TRS (Stereo), Master Volume slider (link with Main output L/Mono)	
		Output Impedance	33 Ω
		Maximum Level	50+ 50 mW @33 Ω
	Digital	Optical S/P DIF	Format: 24 bit, S/P DIF IEC60958 EIAJCP-1201
			Sample Rate: 48 kHz or 96 kHz
Digital output of the same signals as L/Mono and R			
EXB-DI Digital Interface Board (Optional)		ADAT output: 24-bit, 8 channels, 48 kHz Sample rate	
		BNC Word Clock input	
Digital output of the same signals as Audio Output (Individual) 1–8; L/R Bus Indiv. Assign allows L/Mono and R to be output			
Audio Inputs			
Analog	Audio inputs 1, 2	Combination XLR and 1/4" TRS (mono), balanced	
		MIC/LINE input level switches 1 & 2.	
		LEVEL knobs 1 & 2.	
		Phantom Power On/Off 1 & 2.	
		Input Impedance	XLR-3-31: 4 k Ω TRS Phone: 10 k Ω
		Nominal Level: LINE	+4 dBu (LEVEL knob = min)
			-36 dBu (LEVEL knob = max)
		Nominal Level: MIC	-22 dBu (LEVEL knob = min)
			-62 dBu (LEVEL knob = max)
		Maximum Level: LINE	+16 dBu (LEVEL knob = min)
			-24 dBu (LEVEL knob = max)
		Maximum Level: MIC	-10 dBu (LEVEL knob = min)
			-50 dBu (LEVEL knob = max)
		Source Impedance	600 Ω
		Signal to noise ratio	95 dB (typical)
Dynamic range	95 dB (typical)		
Crosstalk	95 dB, at 1 kHz (typical)		
	Audio Inputs 3, 4	1/4" TS (Mono), unbalanced	
		Input Impedance	10 k Ω
		Nominal Level	+4.0 dBu
		Maximum Level	+16 dBu
		Source Load Impedance	600 Ω
		Signal to noise ratio	100 dB (typical)
		Dynamic range	100 dB (typical)
		Crosstalk	100 dB, at 1 kHz (typical)
Digital	Optical S/P DIF	Format: 24 bit, S/P DIF IEC60958 EIAJCP-1201 Sample Rate: 48 kHz or 96 kHz	
Control Inputs	DAMPER (Supports piano-style half-damper pedals as well as standard foot switches) ASSIGNABLE SWITCH, ASSIGNABLE PEDAL		
MIDI	IN, OUT, THRU		
USB	4 USB 2.0 High-Speed ports (supports 480 Mbps) (TYPE A) with Mass Storage Device support, for connecting external hard drives, flash memory, etc.		
Disk Drive	HDD (2.5" 40 GB), CD-R/RW		
RAM memory	1 GB, expandable to 2 GB * RAM memory is used as the system area, ROM RAM, user sampling RAM, and for optional EXs.		
Power	AC Power Supply terminal, POWER On/Off switch		
Dimensions (W x D x H)	88 Keys: 1,458 x 484 x 135 (mm)		
	76 Keys: 1,266 x 484 x 135 (mm)		
Weight	88 Keys: 32.1 kg		
	76 Keys: 25.7 kg		
Power Consumption	88 Keys: 130W		
	76 Keys: 130W		
Accessories	AC cable, Owner's Manuals, Restore CDs		

Options

Hardware	EXB-DI Digital Interface Board	ADAT output: 24-bit, 8 channels, 48 kHz Sample rate BNC Word Clock input
	Expression/Volume Pedal	XVP-10
	Foot Controller	EXP-2
	Damper Pedal	DS-1H
	Pedal Switch	PS-1
	Others	MIDI Cable
Software	EXs Expansion Samples:	Expansion PCM library (available for purchase in the near future)
	EXi Expansion Instruments:	Expansion Instruments library
	EXf Expansion Effects:	Expansion Effects library (available for purchase in the near future)

* Appearance and specifications of this product are subject to change without notice. (April/'05)

IMPORTANT NOTICE TO CONSUMERS

This product has been manufactured according to strict specifications and voltage requirements that are applicable in the country in which it is intended that this product should be used. If you have purchased this product via the internet, through mail order, and/or via a telephone sale, you must verify that this product is intended to be used in the country in which you reside.

WARNING: Use of this product in any country other than that for which it is intended could be dangerous and could invalidate the manufacturer's or distributor's warranty.

Please also retain your receipt as proof of purchase otherwise your product may be disqualified from the manufacturer's or distributor's warranty.

KORG KORG INC.

4015-2 Yanokuchi, Inagi-city, Tokyo 206-0812 Japan